

11th Black Hills & AAU Folk. Nationals

Tot 35
Mat 1

Round 1

Eli Lonski Sidney Wrestlin	21	Eli Lonski Sidney Wrestlin
Hunter Beeman Project Wrestli		Fall 1:27

Sam Koyama Hardin Wrestlin	22	urijah duran Duran Wrestling
urijah duran Duran Wrestling		Fall 0:16

Round 2

Eli Lonski Sidney Wrestlin	62	urijah duran Duran Wrestling
urijah duran Duran Wrestling		Fall 0:26

Sam Koyama Hardin Wrestlin	63	Hunter Beeman Project Wrestli
Hunter Beeman Project Wrestli		Fall 0:56

Round 3

Eli Lonski Sidney Wrestlin	96	Eli Lonski Sidney Wrestlin
Sam Koyama Hardin Wrestlin		Dec 8-7

urijah duran Duran Wrestling	97	urijah duran Duran Wrestling
Hunter Beeman Project Wrestli		Fall 0:25

u. duran (Duran Wrestling Club)
1ST

E. Lonski (Sidney Wrestling Club)
2ND

H. Beeman (Project Wrestling)
3RD

S. Koyama (Hardin Wrestling Club)
4TH

11th Black Hills & AAU Folk. Nationals

Tot 40 Mat 1

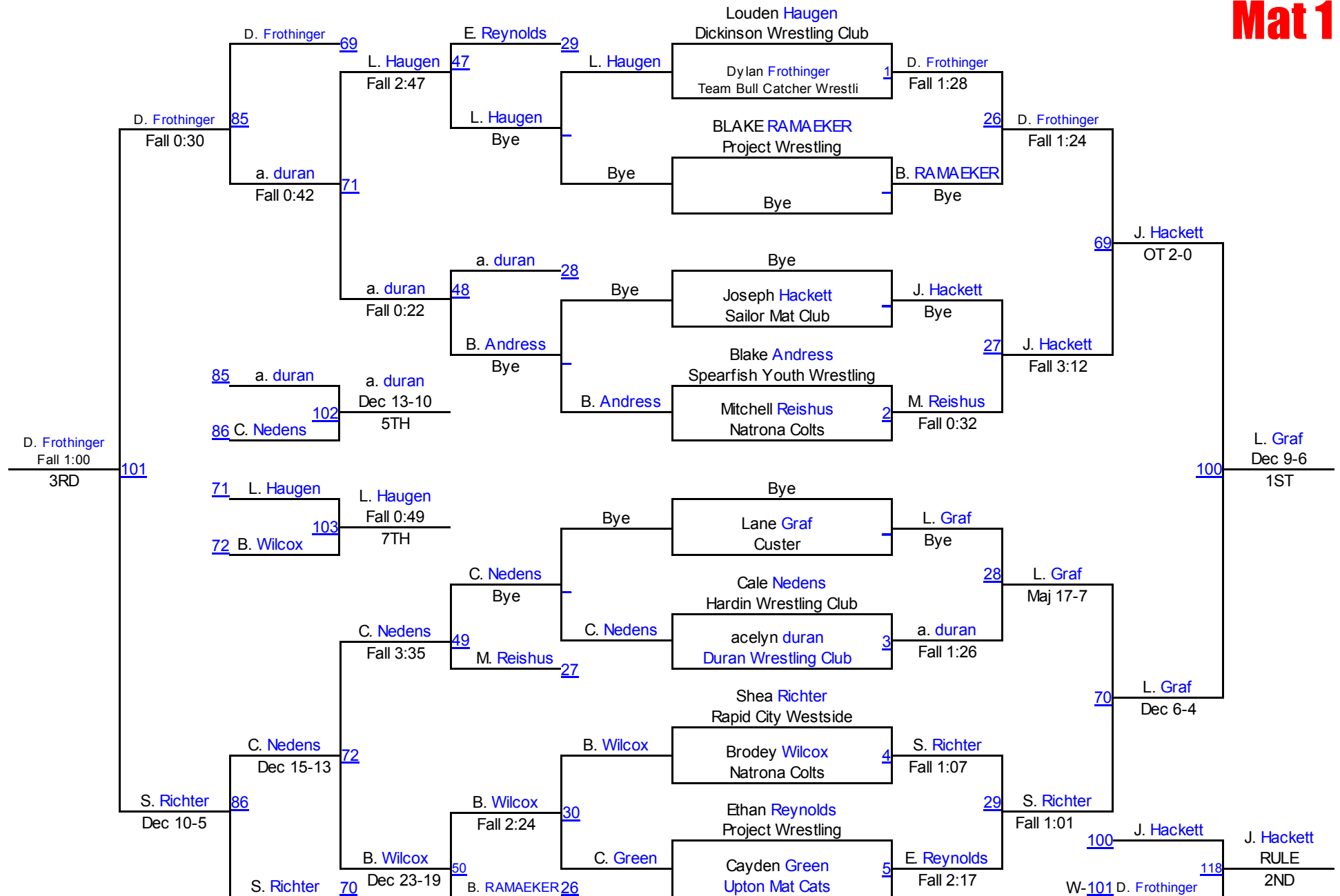

11th Black Hills & AAU Folk. Nationals

Tot 45 Mat 1

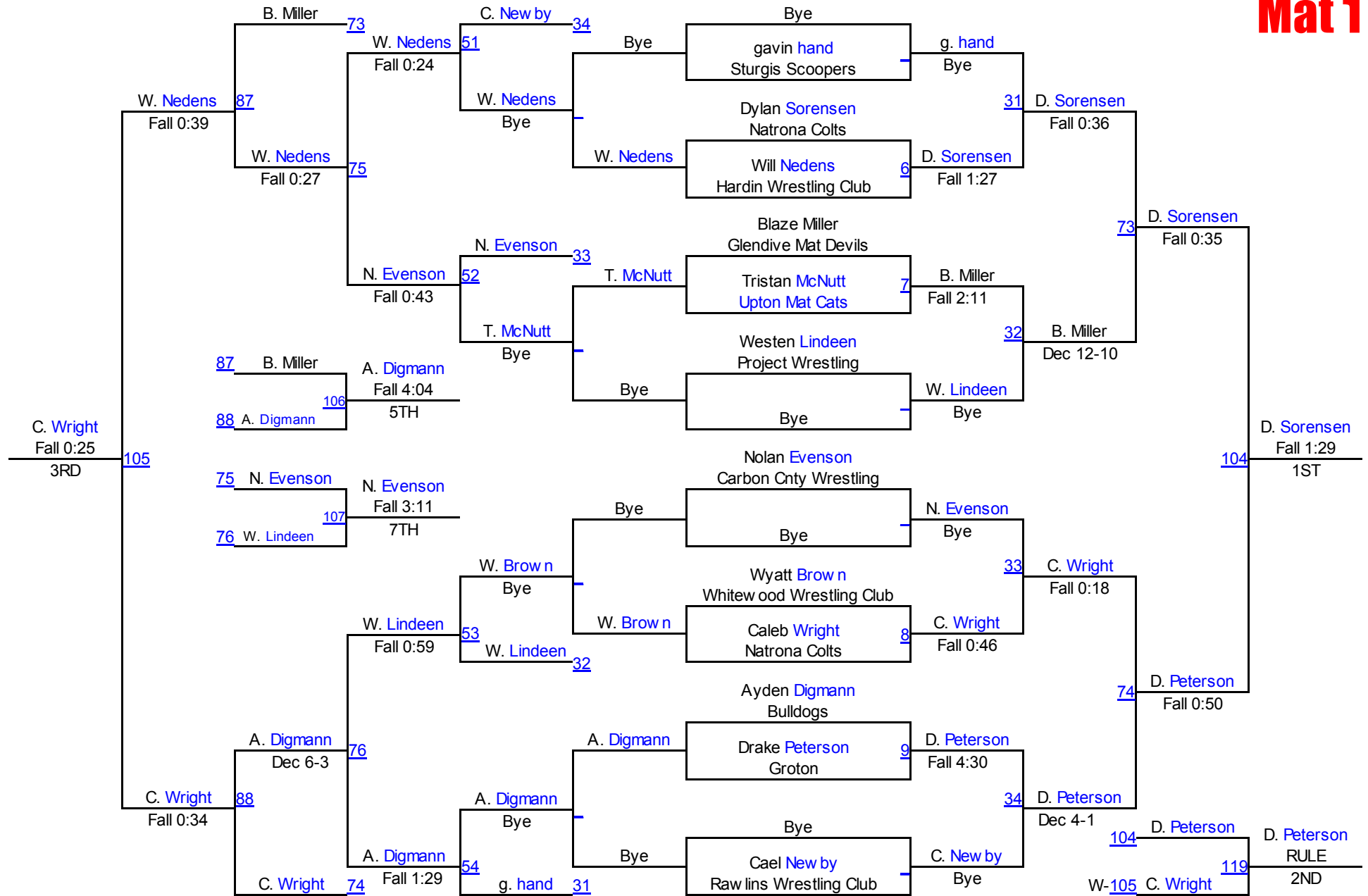

11th Black Hills & AAU Folk. Nationals

Tot 50 Mat 1

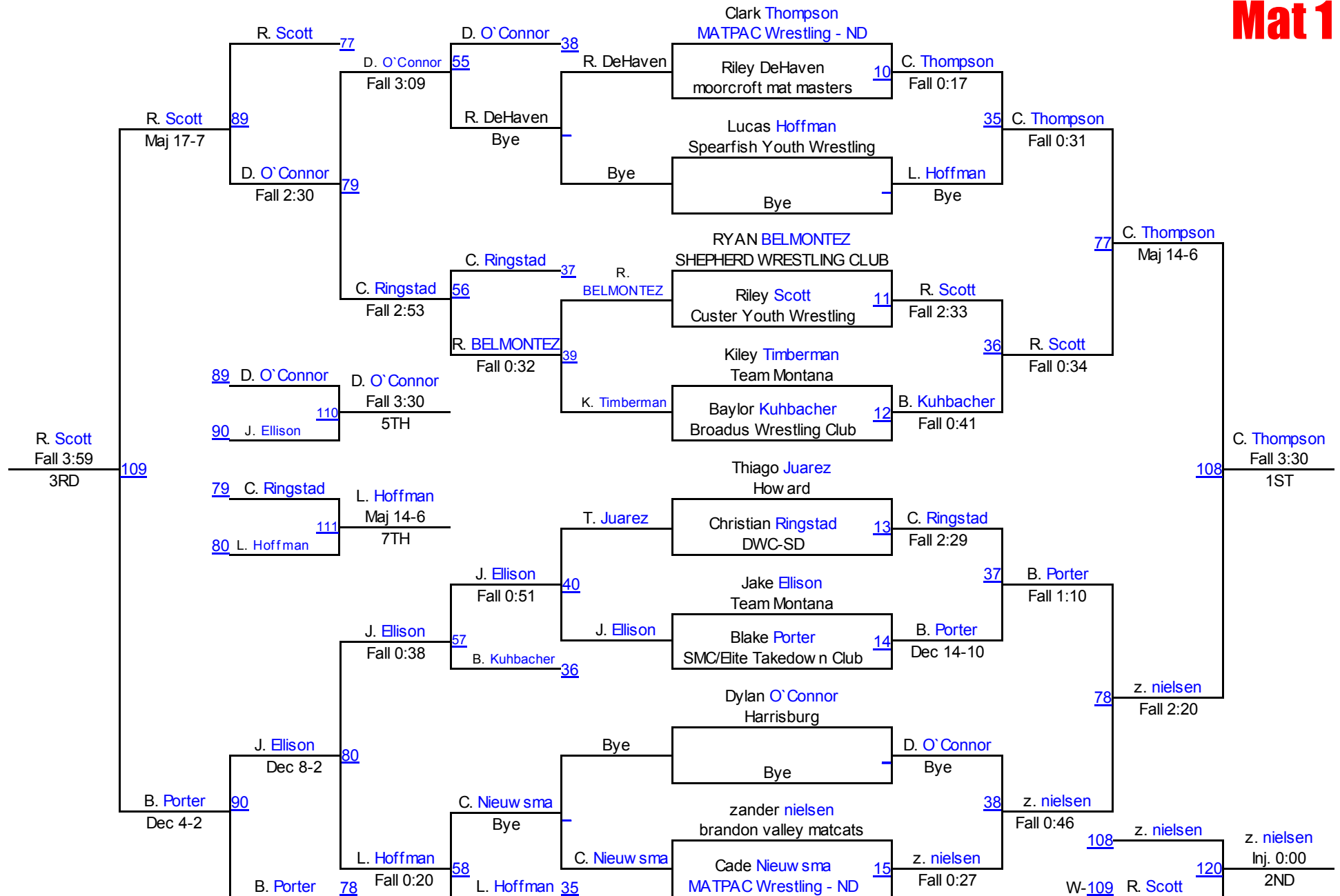

11th Black Hills & AAU Folk. Nationals

Tot 55
Mat 1

Round 1

Roper Eaton		Roper Eaton
Dupree Youth Wr		Dupree Youth Wr
Ravin Annis	23	Dupree Youth Wr
Eagle Butte		Fall 0:22

Nicholas (Ni Reske)		Trenton Bruno
Glendive Mat De		Douglas Wrestli
Trenton Bruno	24	Maj 14-0
Douglas Wrestli		

Round 2

Roper Eaton		Roper Eaton
Dupree Youth Wr		Dupree Youth Wr
Trenton Bruno	64	Maj 16-2
Douglas Wrestli		

Nicholas (Ni Reske)		Ravin Annis
Glendive Mat De		Eagle Butte
Ravin Annis	65	Fall 4:12
Eagle Butte		

Round 3

Roper Eaton		Roper Eaton
Dupree Youth Wr		Dupree Youth Wr
Nicholas (Ni Reske)	98	Fall 0:13
Glendive Mat De		

Trenton Bruno		Ravin Annis
Douglas Wrestli		Eagle Butte
Ravin Annis	99	Fall 2:27
Eagle Butte		

- R. Eaton (Dupree Youth Wrestling Cl)
1ST
- R. Annis (Eagle Butte)
2ND
- T. Bruno (Douglas Wrestling Club -)
3RD
- N. Reske (Glendive Mat Devils)
4TH

11th Black Hills & AAU Folk. Nationals

Tot Hwt Mat 1

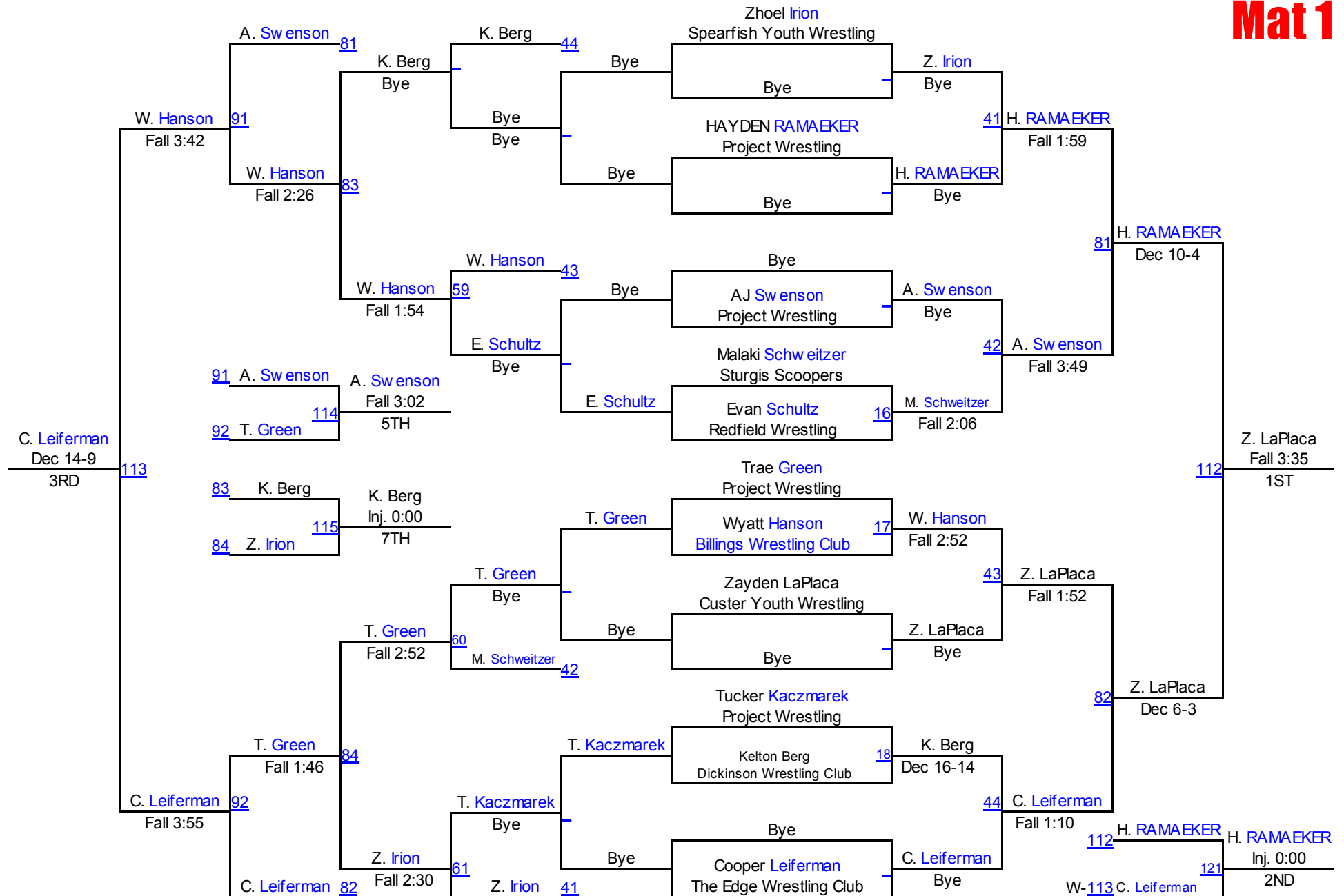

11th Black Hills & AAU Folk. Nationals

Bantam 40 Mat 1

Round 1

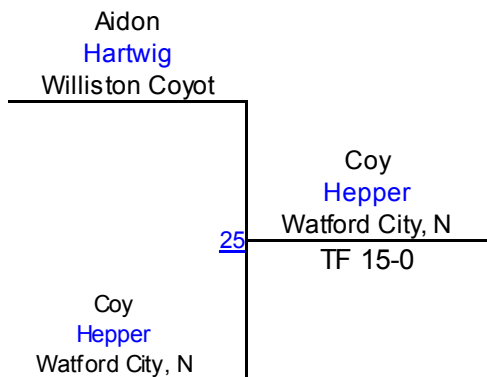

Round 2

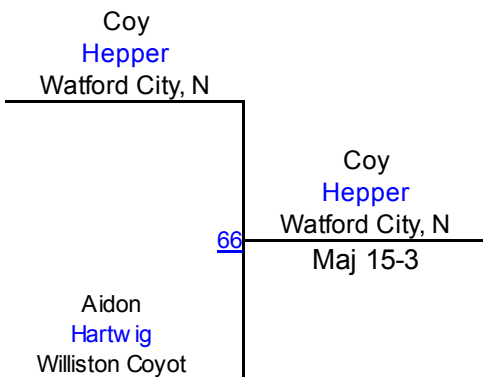

Round 3

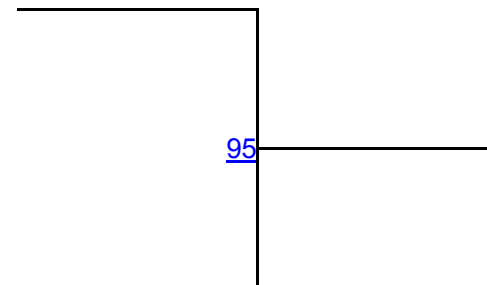

C. Hepper (Watford City, ND)
 1ST

A. Hartwig (Williston Coyotes)
 2ND

11th Black Hills & AAU Folk. Nationals

Bantam 45 Mat 1

Round 1

Tyler Schultz Redfield Wrestl	Haven Green Upton Mat Cats
Haven Green Upton Mat Cats	TF 20-5
19	

Charlie Irwin New Salem	Trayton Weiss Custer Youth Wr
Trayton Weiss Custer Youth Wr	Fall 4:24
20	

T. Weiss (Custer Youth Wrestling)
1ST

Round 2

Roman McWilliams Rapid City West	Trayton Weiss Custer Youth Wr
Trayton Weiss Custer Youth Wr	Fall 3:47
45	

Tyler Schultz Redfield Wrestl	Charlie Irwin New Salem
Charlie Irwin New Salem	Fall 0:26
46	

R. McWilliams (Rapid City Westside)
2ND

Round 3

Roman McWilliams Rapid City West	Roman McWilliams Rapid City West
Charlie Irwin New Salem	Dec 5-2
67	

Haven Green Upton Mat Cats	Trayton Weiss Custer Youth Wr
Trayton Weiss Custer Youth Wr	Fall 4:19
68	

C. Irwin (New Salem)
3RD

Round 4

Roman McWilliams Rapid City West	Roman McWilliams Rapid City West
Haven Green Upton Mat Cats	Fall 1:52
93	

Tyler Schultz Redfield Wrestl	Trayton Weiss Custer Youth Wr
Trayton Weiss Custer Youth Wr	Fall 2:27
94	

H. Green (Upton Mat Cats)
4TH

Round 5

Roman McWilliams Rapid City West	Roman McWilliams Rapid City West
Tyler Schultz Redfield Wrestl	Fall 0:33
116	

Haven Green Upton Mat Cats	Charlie Irwin New Salem
Charlie Irwin New Salem	Fall 0:19
117	

T. Schultz (Redfield Wrestling)
5TH

11th Black Hills & AAU Folk. Nationals

Bantam 50 Mat 2

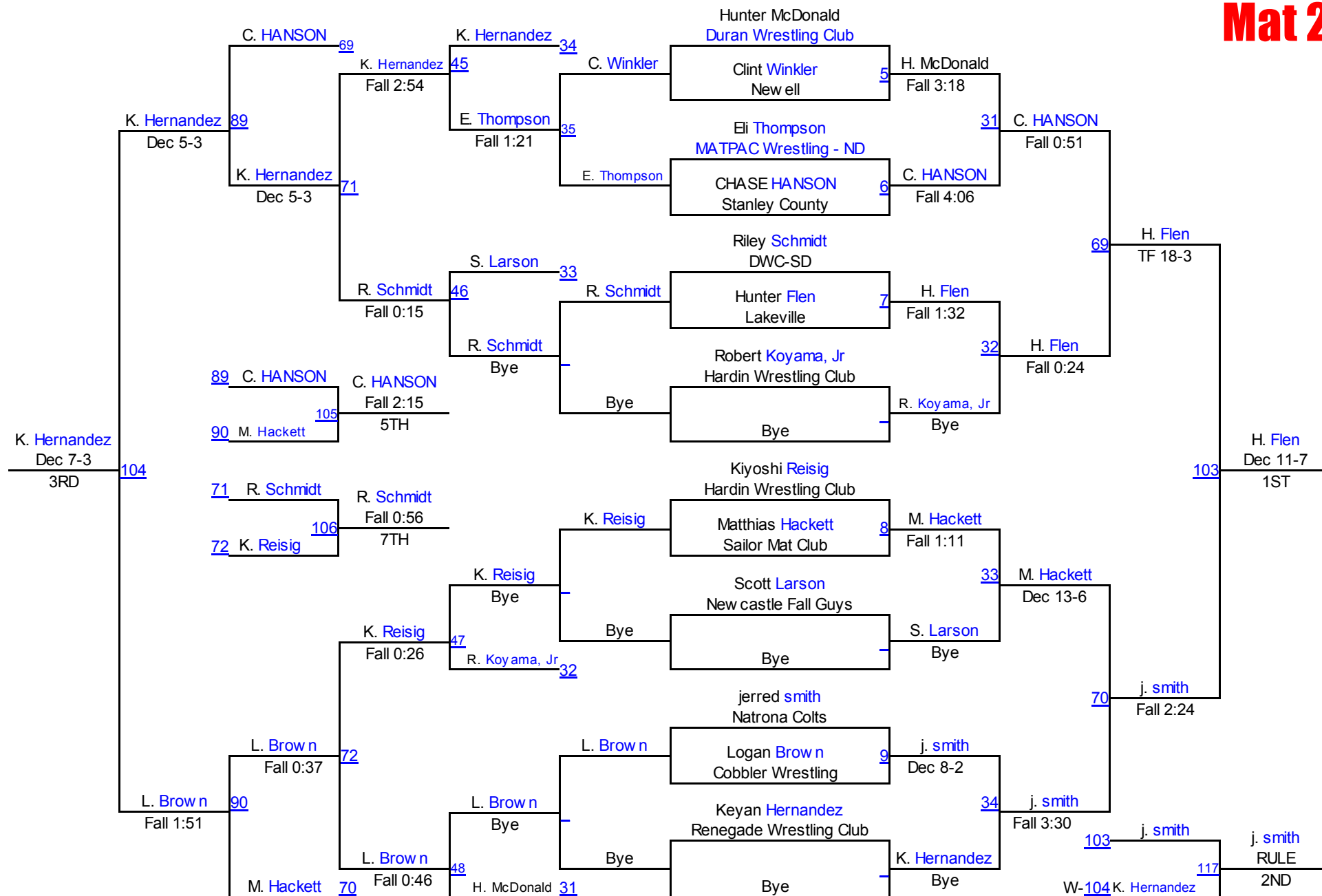

11th Black Hills & AAU Folk. Nationals

Bantam 55 Mat 2

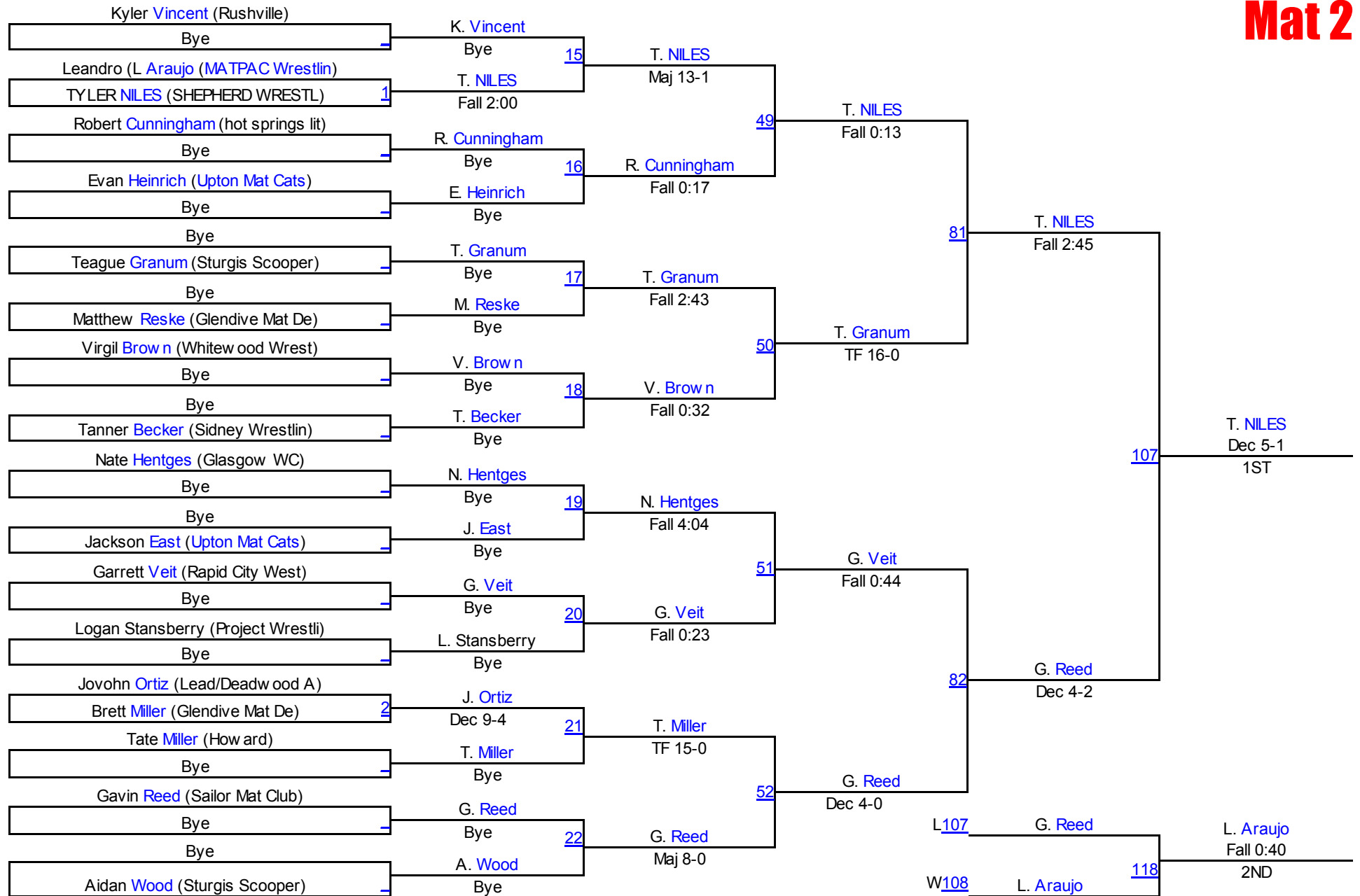

Bantam 55

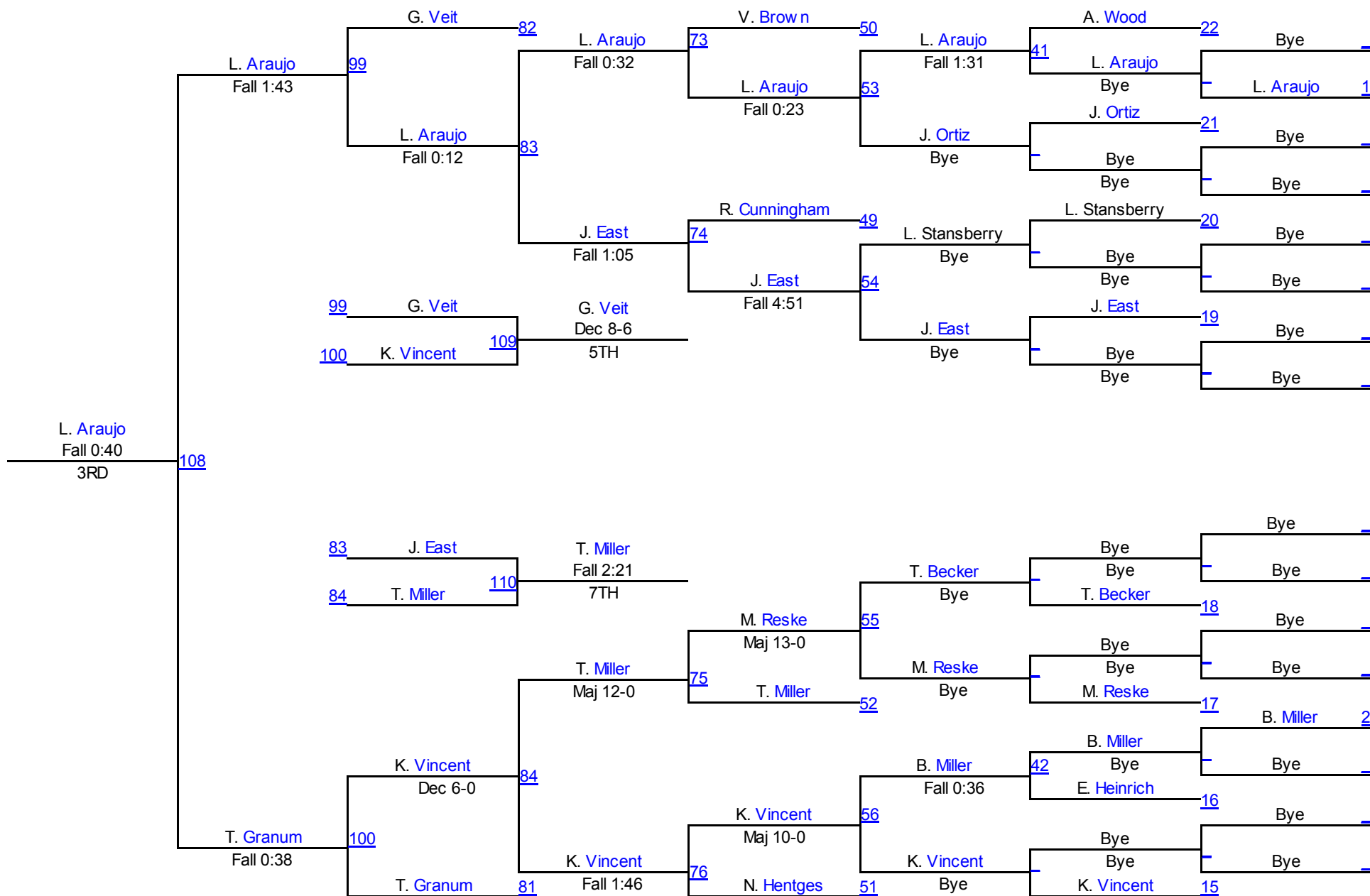

11th Black Hills & AAU Folk. Nationals

Bantam 60 Mat 2

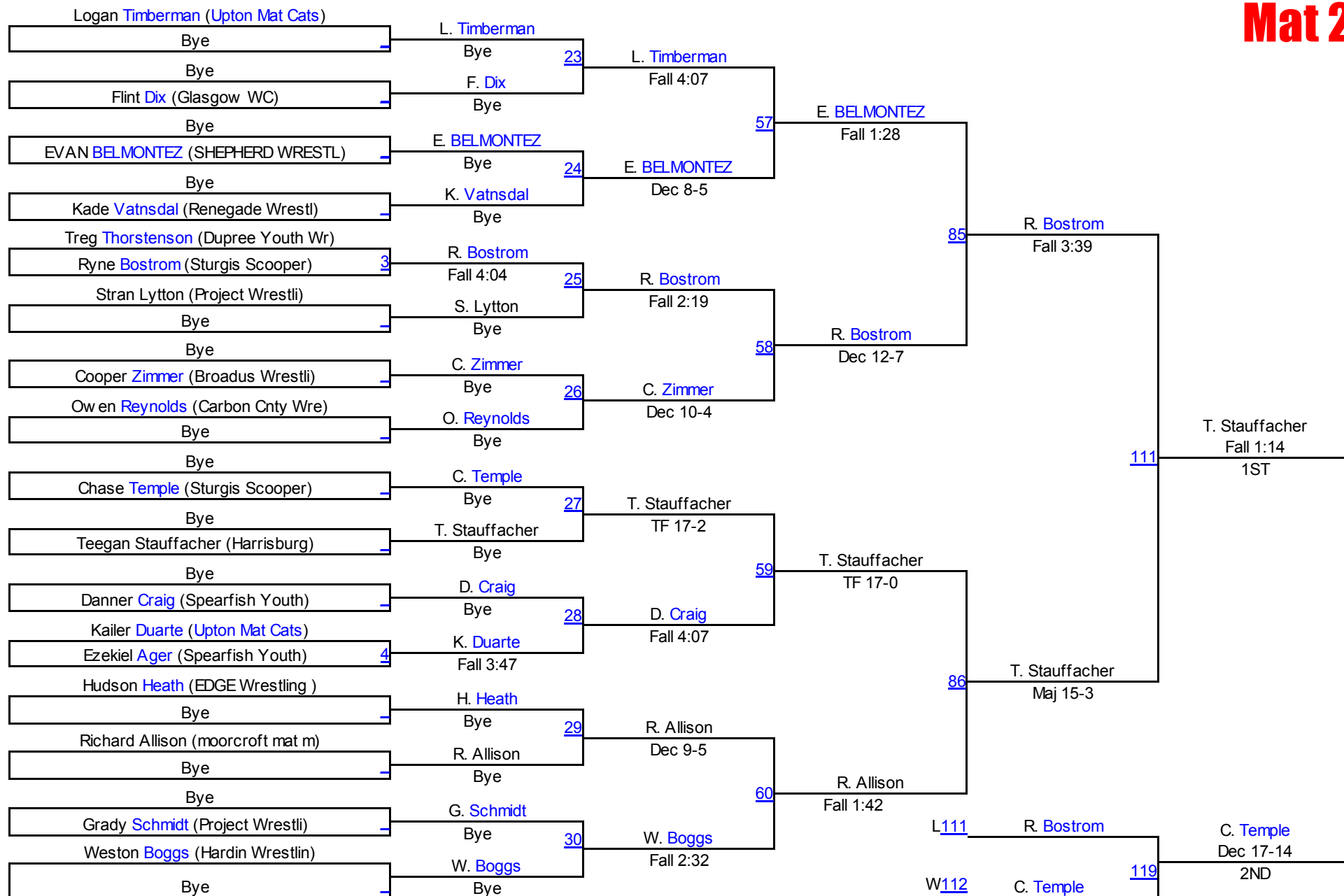

Bantam 60

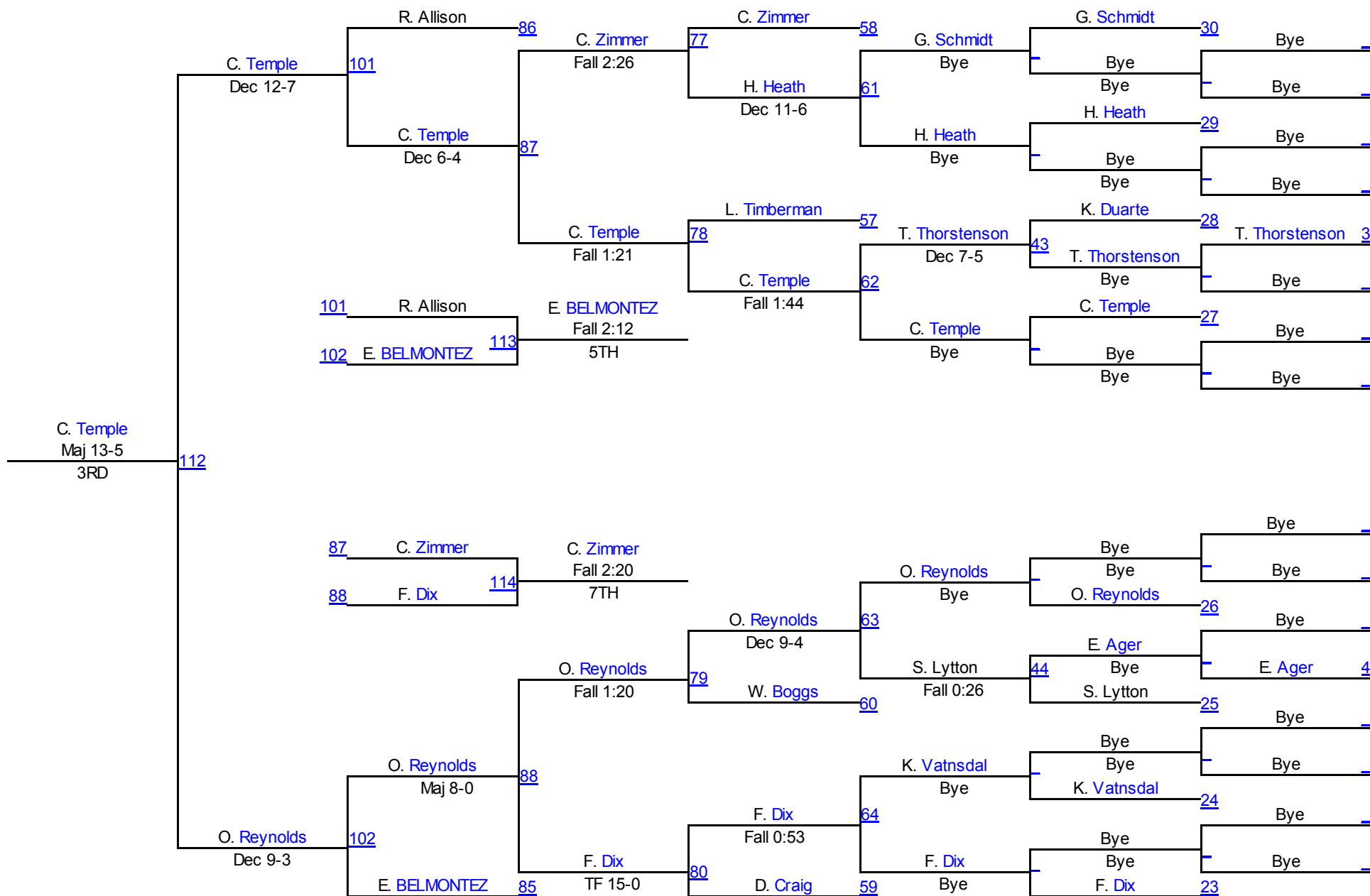

11th Black Hills & AAU Folk. Nationals

Bantam 65 Mat 3

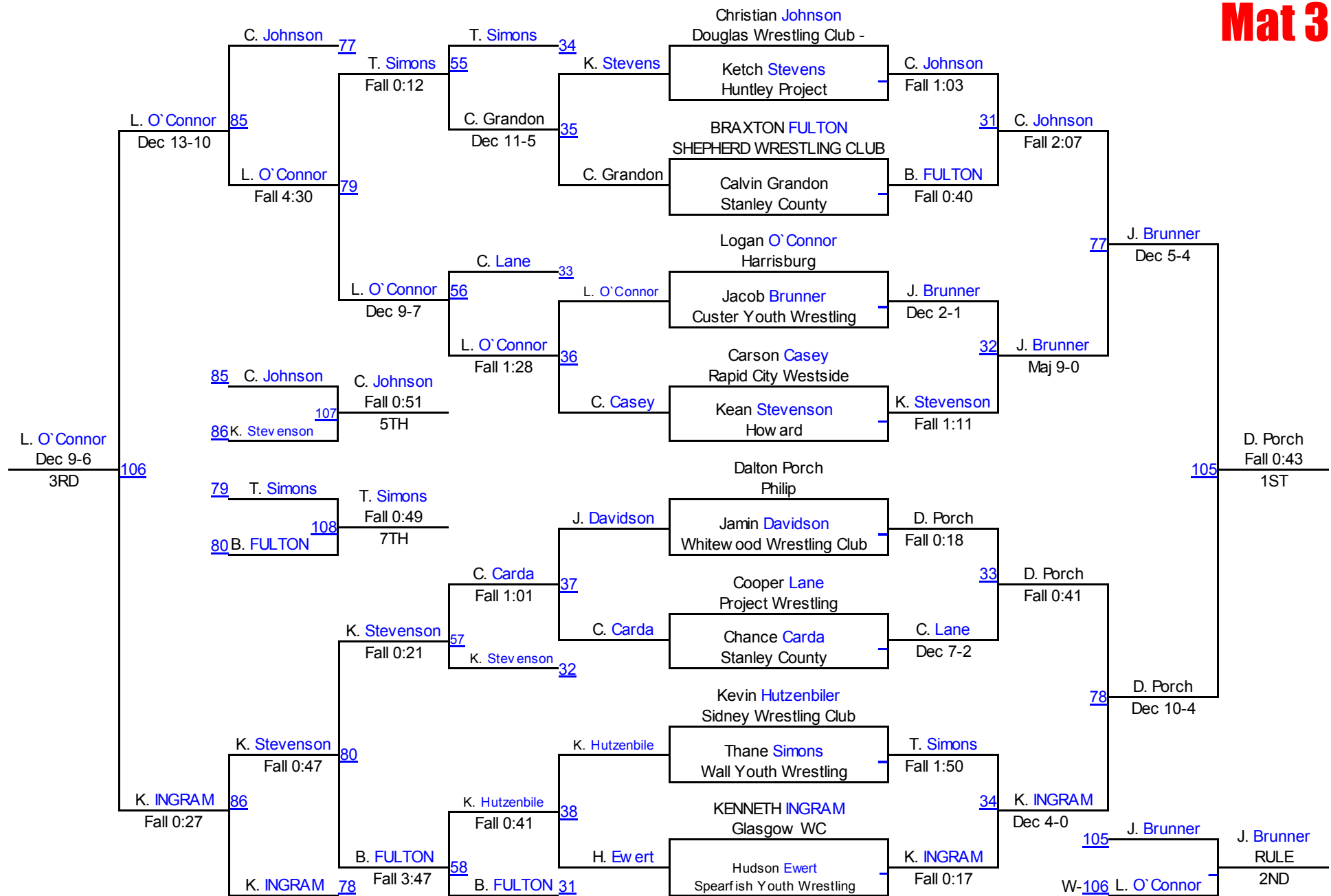

11th Black Hills & AAU Folk. Nationals

Bantam 70 Mat 2

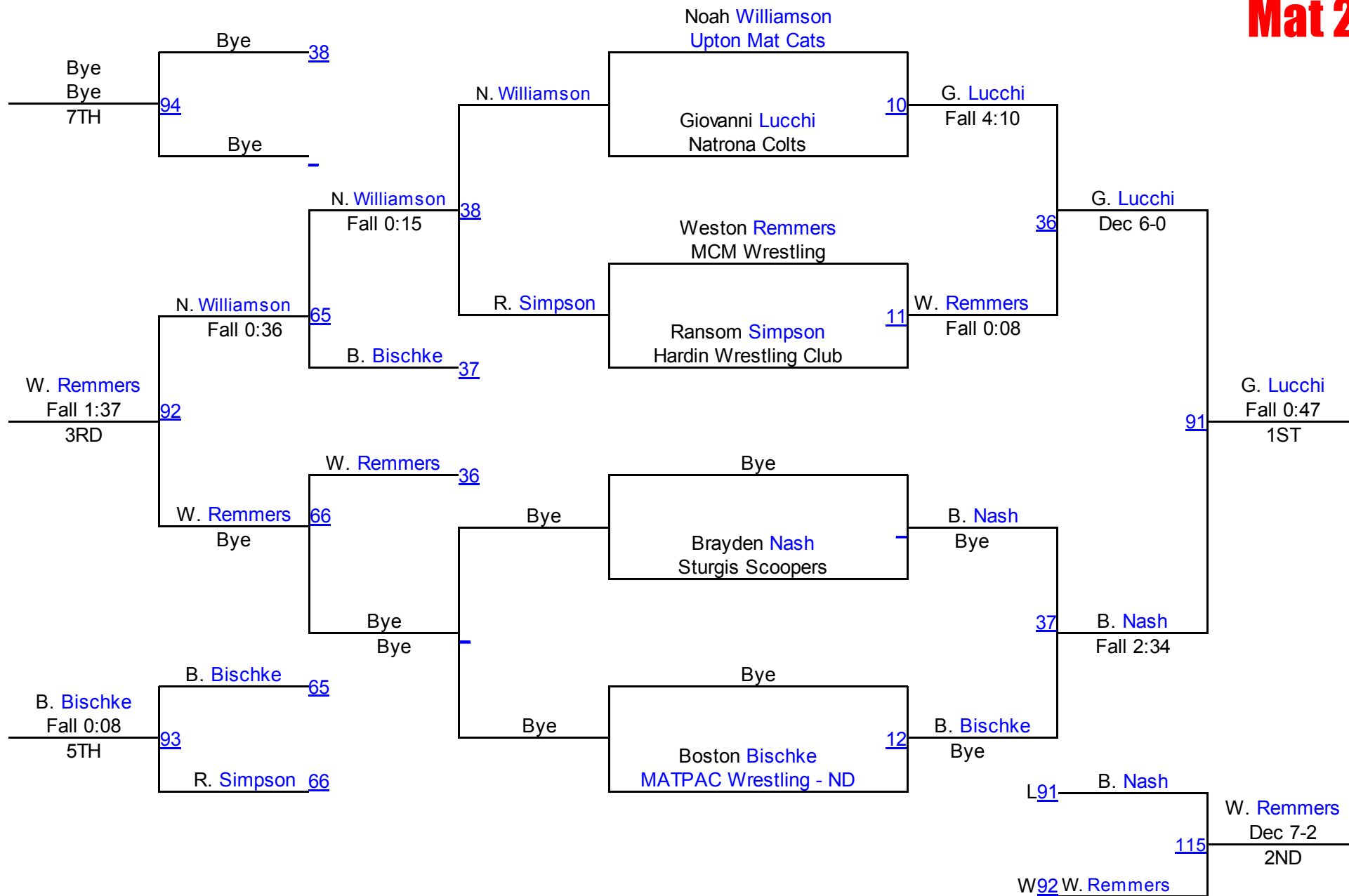

11th Black Hills & AAU Folk. Nationals

Bantam 75 Mat 2

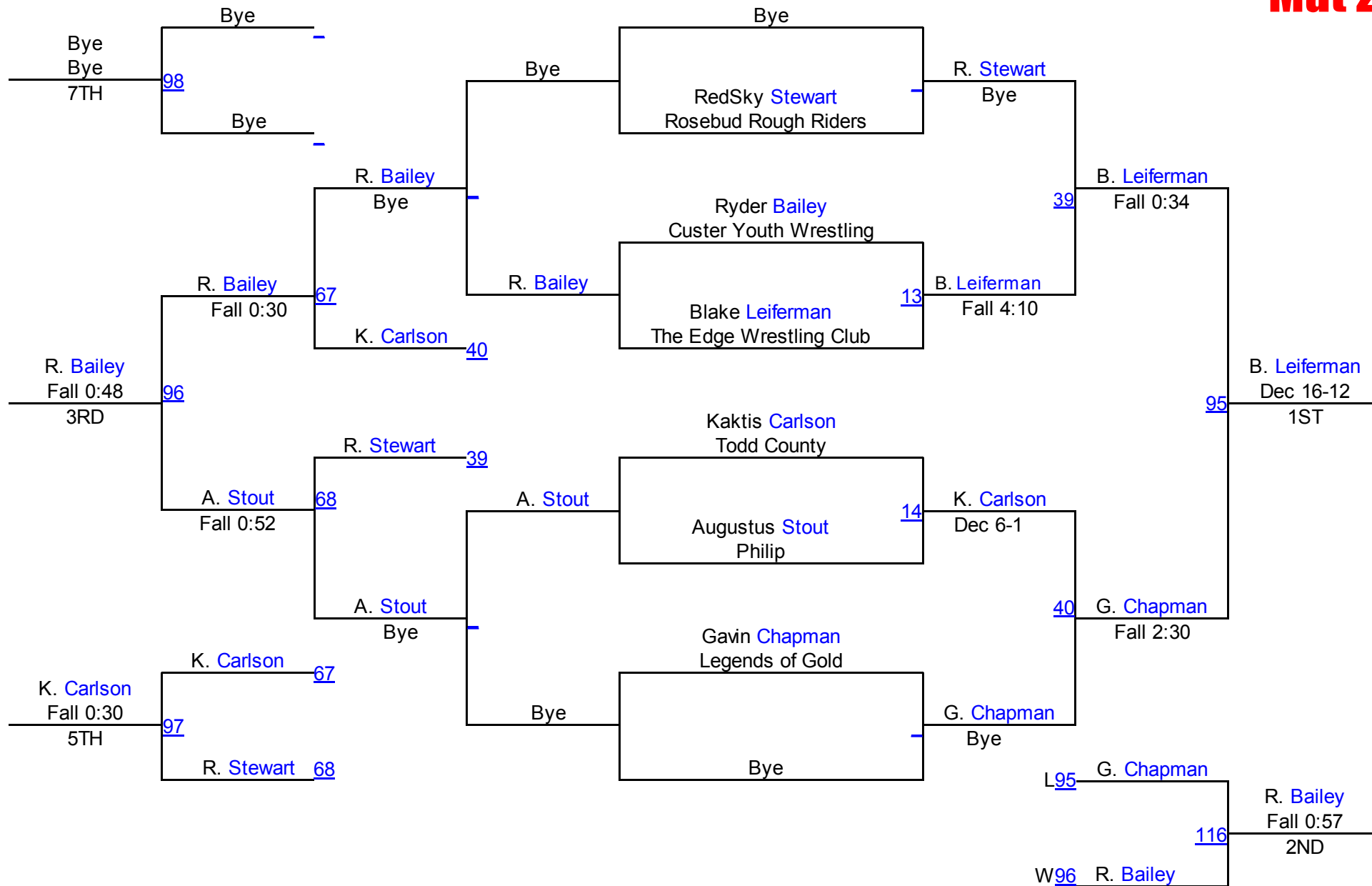

11th Black Hills & AAU Folk. Nationals

Bantam 80 Mat 3

Round 1

Darrin Wilson Hardin Wrestlin	Carter Gibson MAHACA
Carter Gibson MAHACA	Fall 1:03

25

Landen Witt Rosebud Rough R	Landen Witt Rosebud Rough R
Charles Ball Renegade Wrestl	Fall 0:49

26

Round 2

Darrin Wilson Hardin Wrestlin	Darrin Wilson Hardin Wrestlin
Charles Ball Renegade Wrestl	Fall 2:48

63

Landen Witt Rosebud Rough R	Carter Gibson MAHACA
Carter Gibson MAHACA	Fall 1:23

64

Round 3

Darrin Wilson Hardin Wrestlin	Landen Witt Rosebud Rough R
Landen Witt Rosebud Rough R	Fall 0:34

99

Charles Ball Renegade Wrestl	Carter Gibson MAHACA
Carter Gibson MAHACA	Fall 0:21

100

C. Gibson (MAHACA)

1ST

L. Witt (Rosebud Rough Riders)

2ND

D. Wilson (Hardin Wrestling Club)

3RD

C. Ball (Renegade Wrestling Club)

4TH

11th Black Hills & AAU Folk. Nationals

Bantam 90 Mat 3

Round 1

Hunter Gibson MAHACA	Hunter Gibson MAHACA
Grady Nielsen Glasgow WC	Fall 0:55
19	

Jesse VanDyke Project Wrestli	Chace Waters Sidney Wrestlin
Chace Waters Sidney Wrestlin	Fall 3:37
20	

H. Gibson (MAHACA)
1ST

Round 2

lincoln koehn Philip	Chace Waters Sidney Wrestlin
Chace Waters Sidney Wrestlin	Dec 10-3
49	

Hunter Gibson MAHACA	Hunter Gibson MAHACA
Jesse VanDyke Project Wrestli	Fall 1:08
50	

C. Waters (Sidney Wrestling Club)
2ND

Round 3

lincoln koehn Philip	lincoln koehn Philip
Jesse VanDyke Project Wrestli	Maj 11-3
71	

Grady Nielsen Glasgow WC	Chace Waters Sidney Wrestlin
Chace Waters Sidney Wrestlin	Dec 8-6
72	

I. koehn (Philip)
3RD

Round 4

lincoln koehn Philip	lincoln koehn Philip
Grady Nielsen Glasgow WC	Fall 3:33
89	

Hunter Gibson MAHACA	Hunter Gibson MAHACA
Chace Waters Sidney Wrestlin	Fall 1:26
90	

G. Nielsen (Glasgow WC)
4TH

Round 5

lincoln koehn Philip	Hunter Gibson MAHACA
Hunter Gibson MAHACA	Maj 8-0
113	

Grady Nielsen Glasgow WC	Grady Nielsen Glasgow WC
Jesse VanDyke Project Wrestli	Dec 9-5
114	

J. VanDyke (Project Wrestling)
5TH

11th Black Hills & AAU Folk. Nationals

Bantam Hwt Mat 3

Round 1

Mason Hennings Hillsboro North	Spencer Higareda Project Wrestli
Spencer Higareda Project Wrestli	Fall 0:28

27

Sequoia Spotted Tail Todd County	Kohl Kittleson Glasgow WC
Kohl Kittleson Glasgow WC	Fall 1:16

28

Round 2

Mason Hennings Hillsboro North	Kohl Kittleson Glasgow WC
Kohl Kittleson Glasgow WC	Fall 0:28

65

Sequoia Spotted Tail Todd County	Spencer Higareda Project Wrestli
Spencer Higareda Project Wrestli	Maj 13-5

66

Round 3

Mason Hennings Hillsboro North	Sequoia Spotted Tail Todd County
Sequoia Spotted Tail Todd County	Fall 0:42

101

Kohl Kittleson Glasgow WC	Kohl Kittleson Glasgow WC
Spencer Higareda Project Wrestli	Fall 0:59

102

K. Kittleson (Glasgow WC)
1ST

S. Spotted Tail (Todd County)
2ND

S. Higareda (Project Wrestling)
3RD

M. Hennings (Hillsboro North Dakota)
4TH

11th Black Hills & AAU Folk. Nationals

Midget 50 Mat 5

Round 1

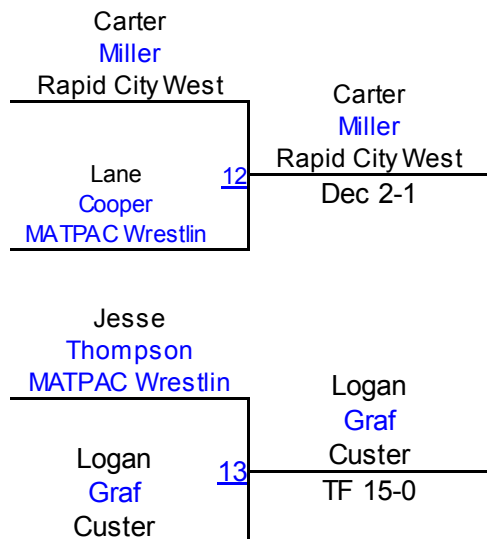

Round 2

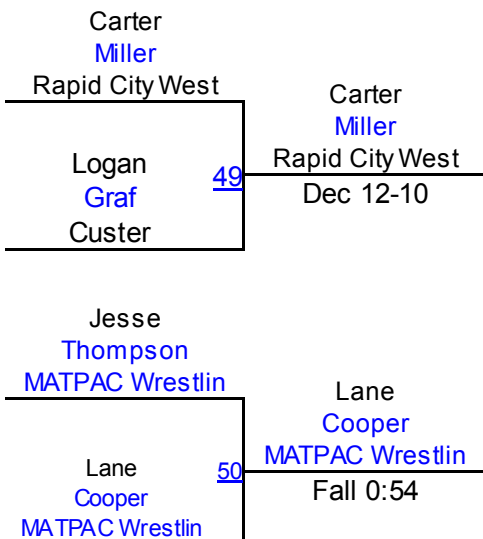

Round 3

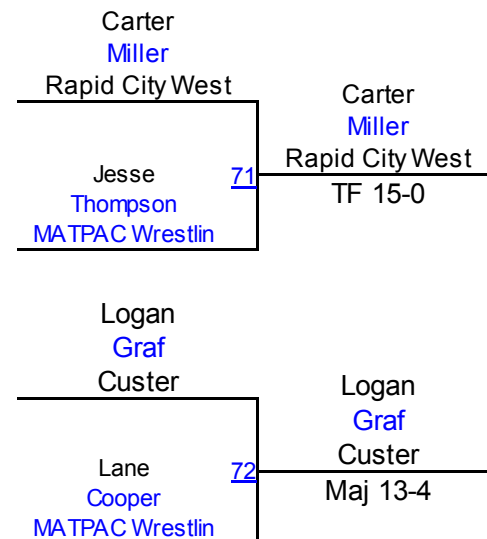

- **1ST**
- C. Miller (Rapid City Westside)
- **2ND**
- L. Graf (Custer)
- **3RD**
- L. Cooper (MATPAC Wrestling - ND)
- **4TH**
- J. Thompson (MATPAC Wrestling - ND)

11th Black Hills & AAU Folk. Nationals

Midget 55 Mat 6

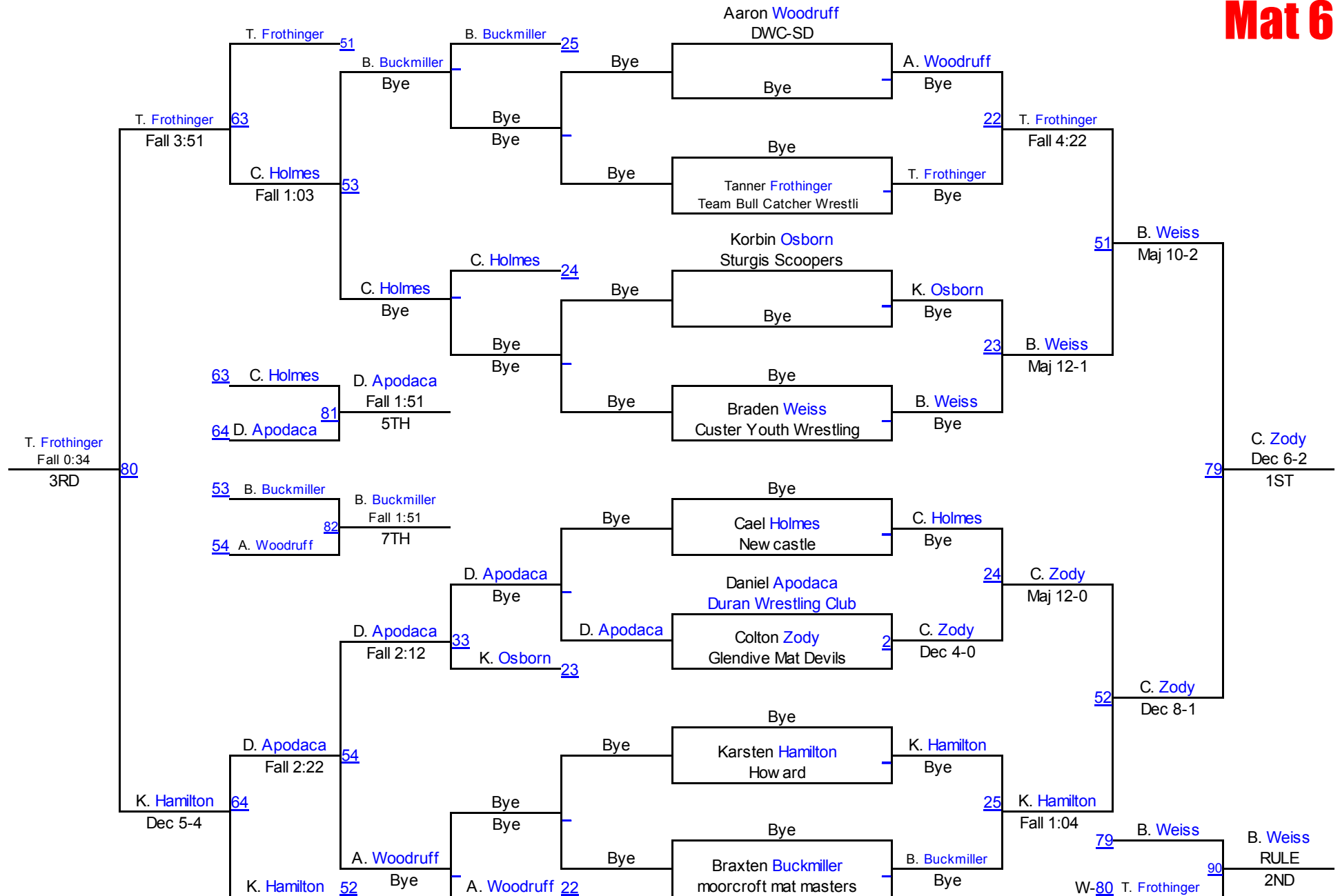

11th Black Hills & AAU Folk. Nationals

Midget 60 Mat 5

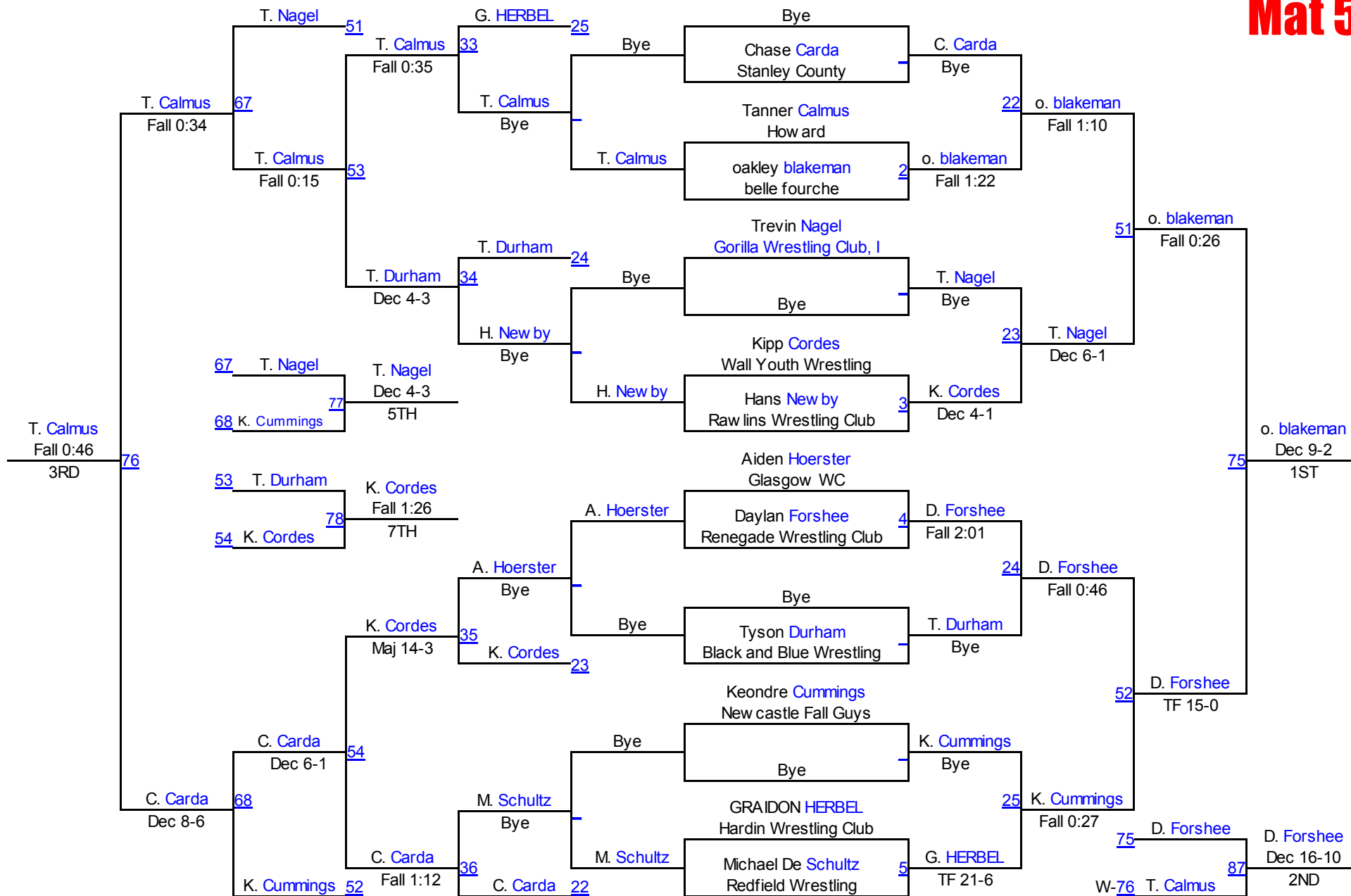

11th Black Hills & AAU Folk. Nationals

Midget 65 Mat 5

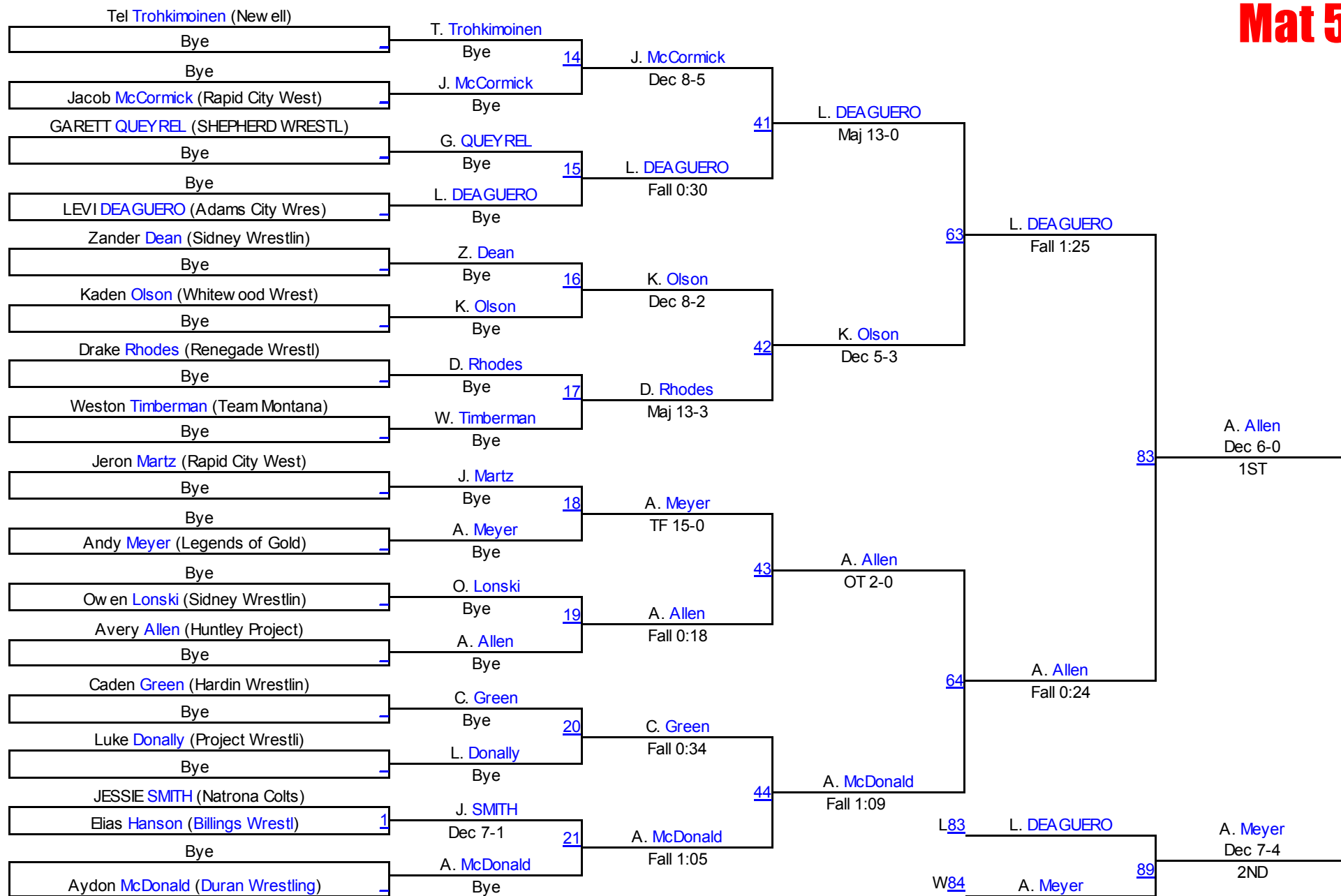

Midget 65

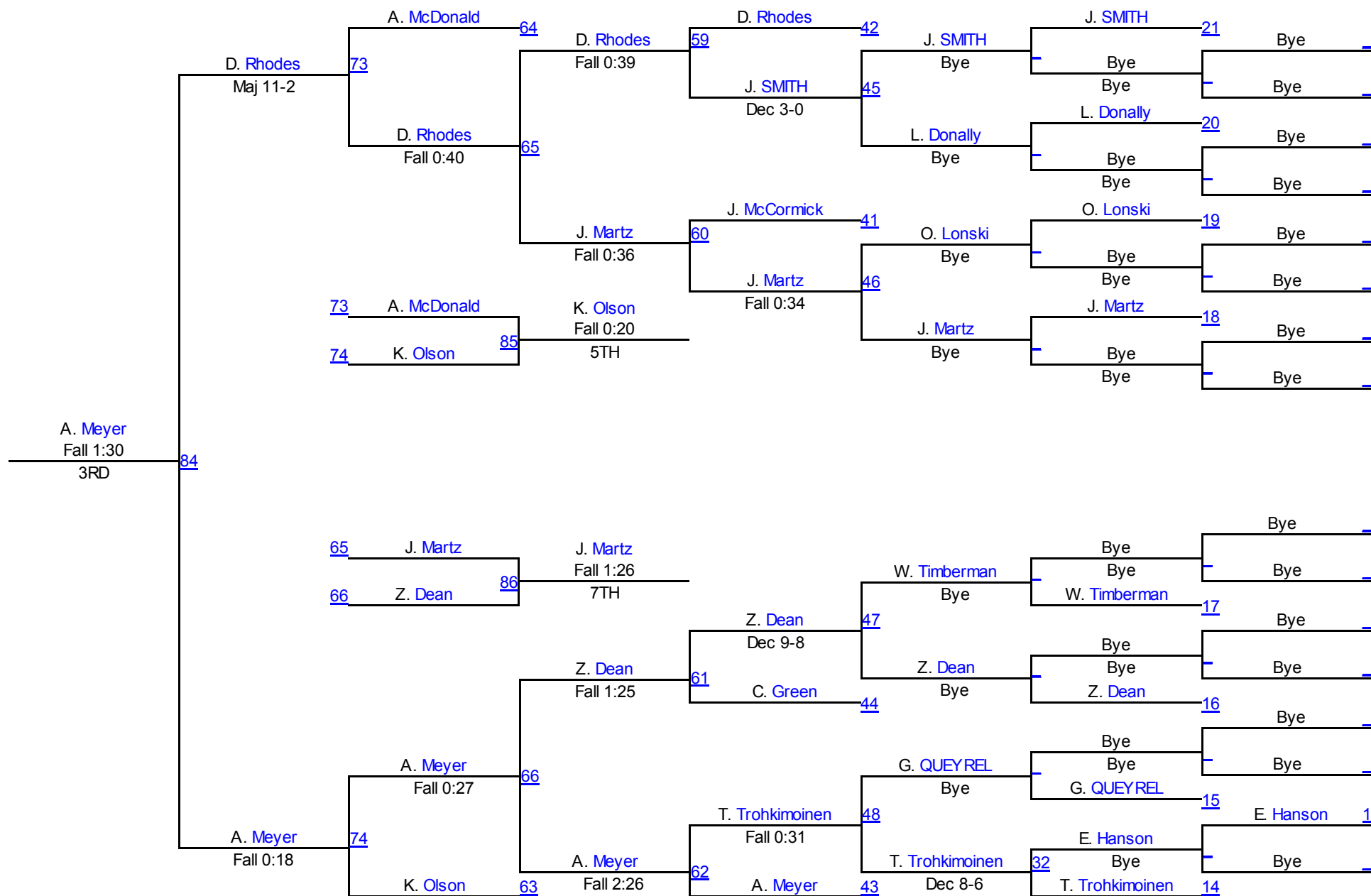

11th Black Hills & AAU Folk. Nationals

Midget 70 Mat 6

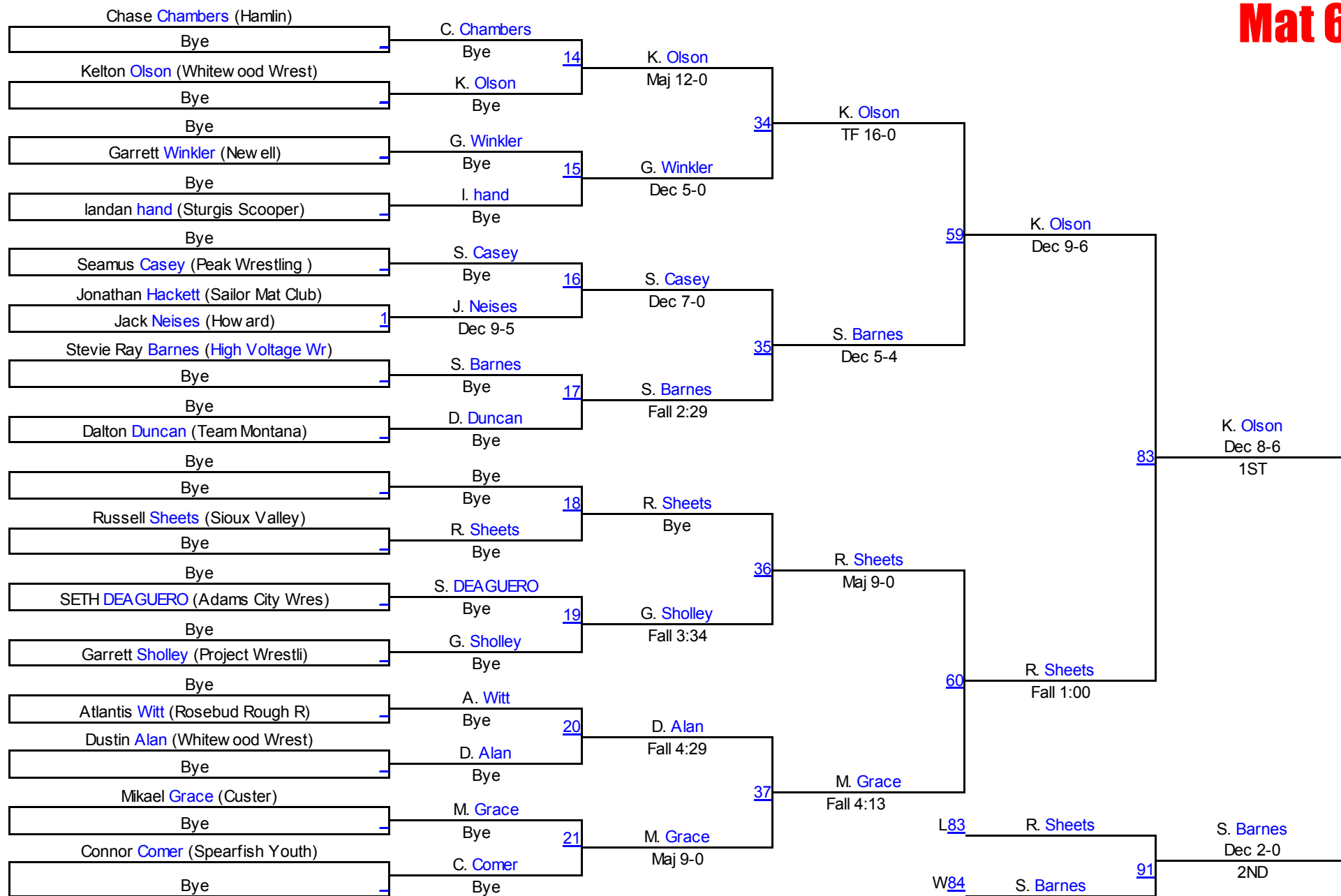

Midget 70

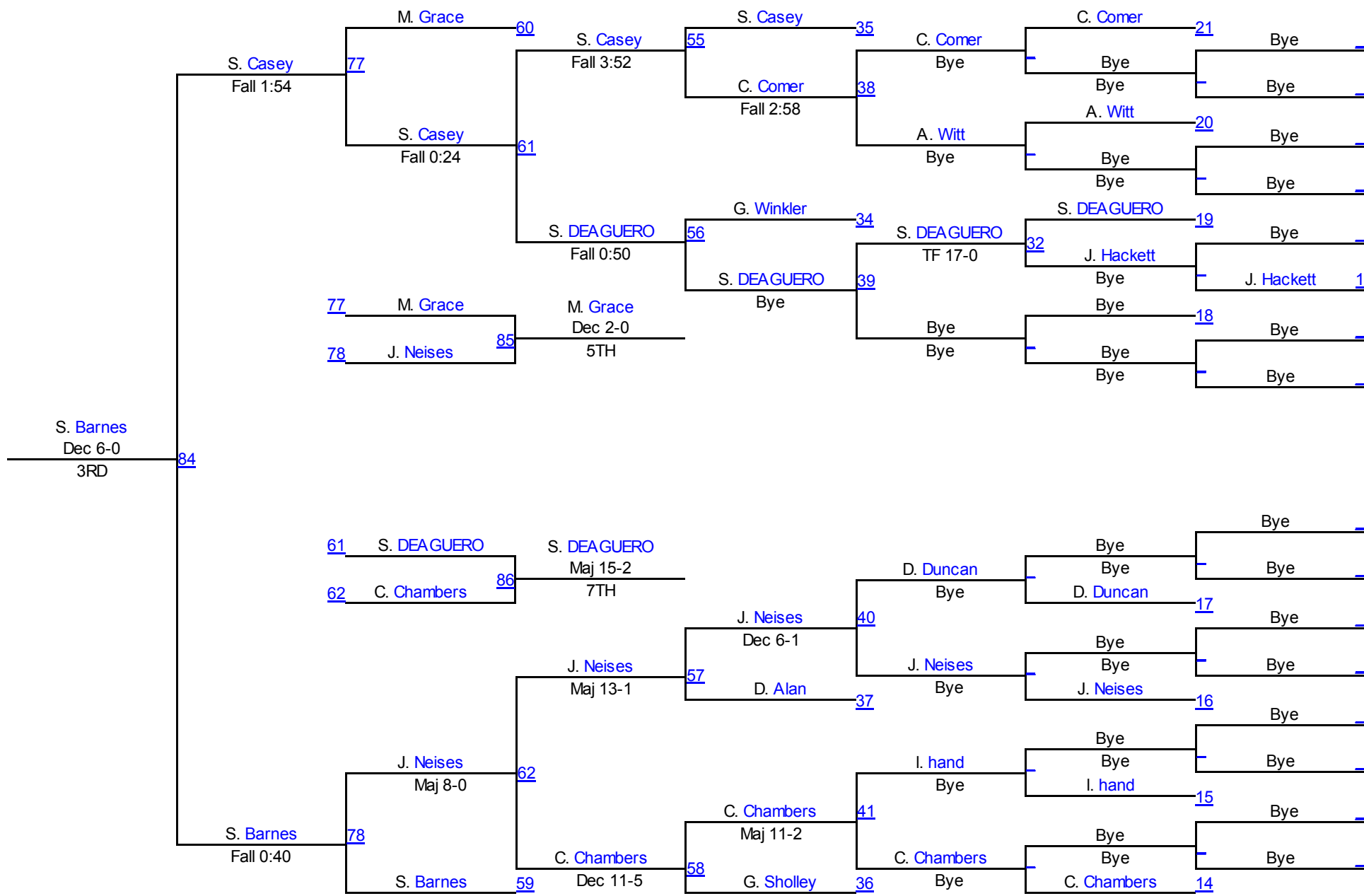

11th Black Hills & AAU Folk. Nationals

Midget 75 Mat 7

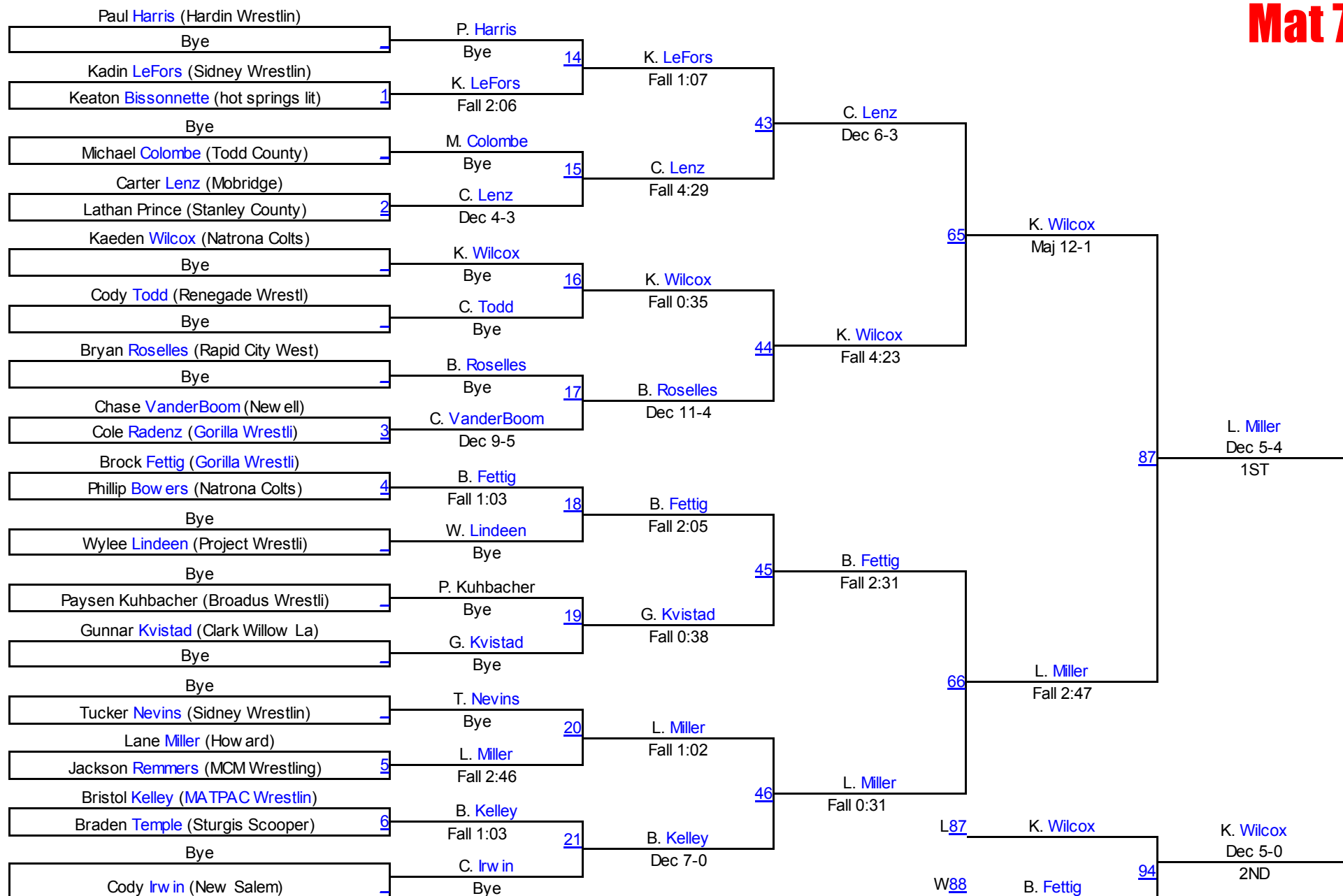

Midget 75

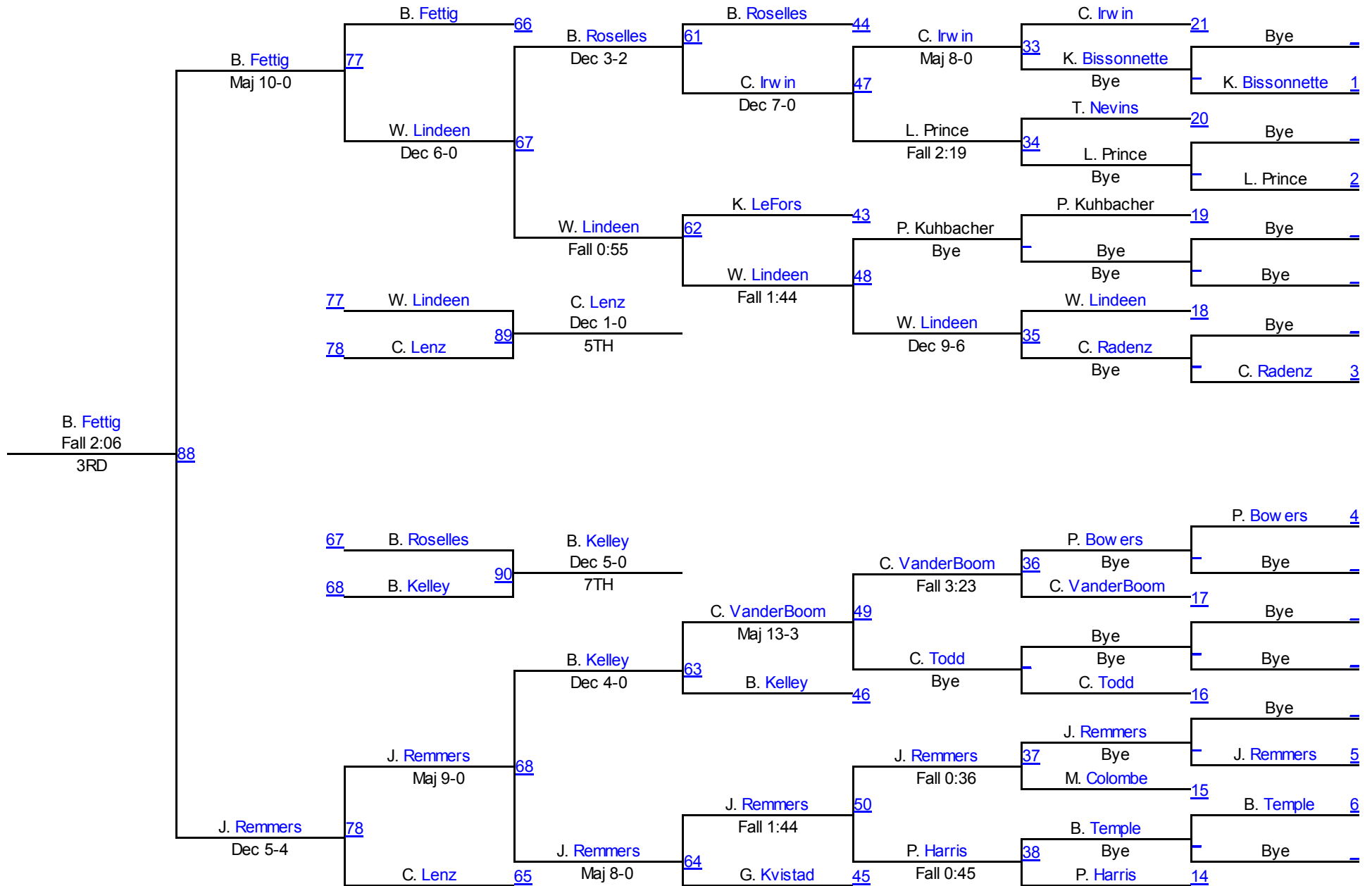

11th Black Hills & AAU Folk. Nationals

Midget 80 Mat 5

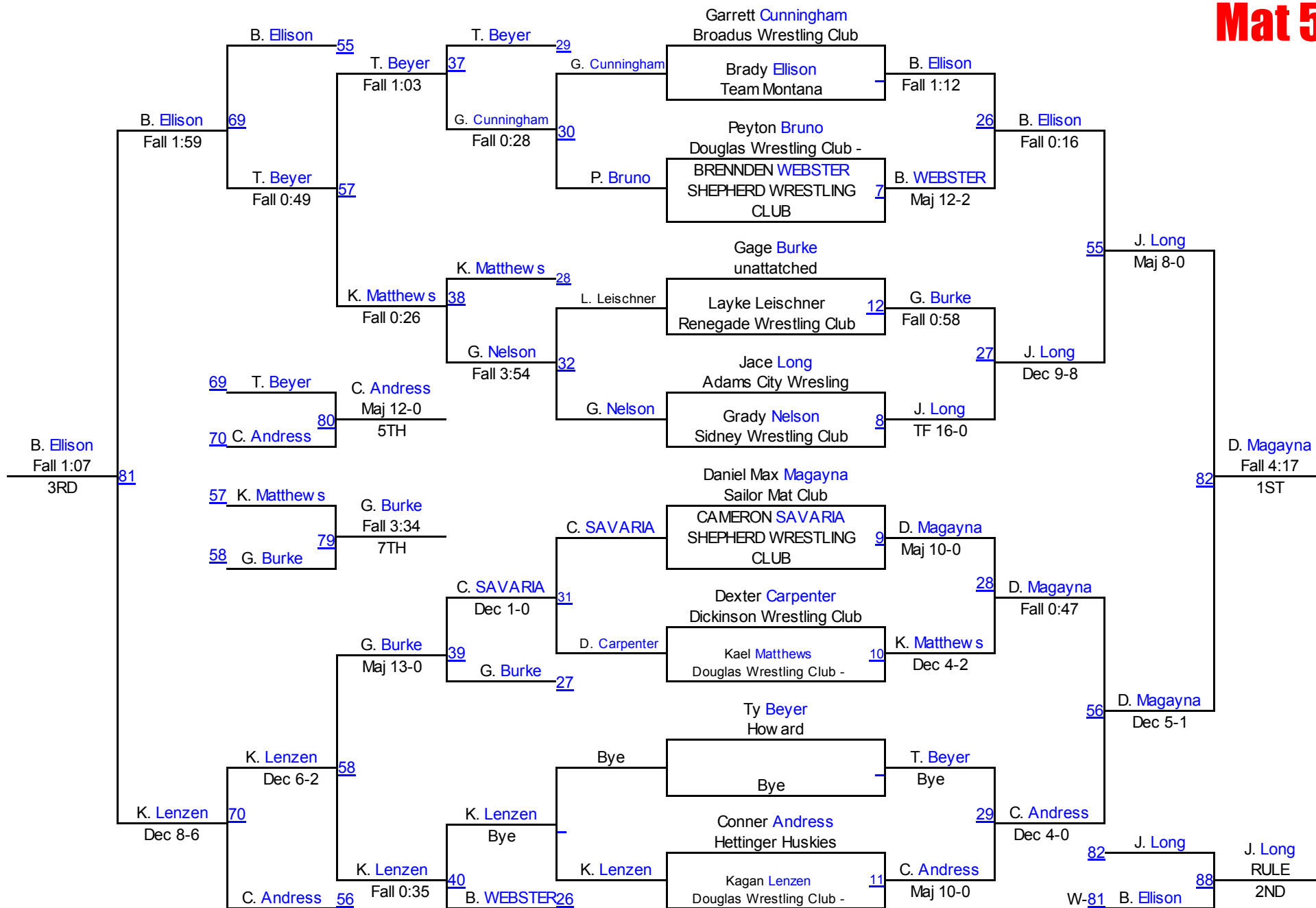

11th Black Hills & AAU Folk. Nationals

Midget 85 Mat 7

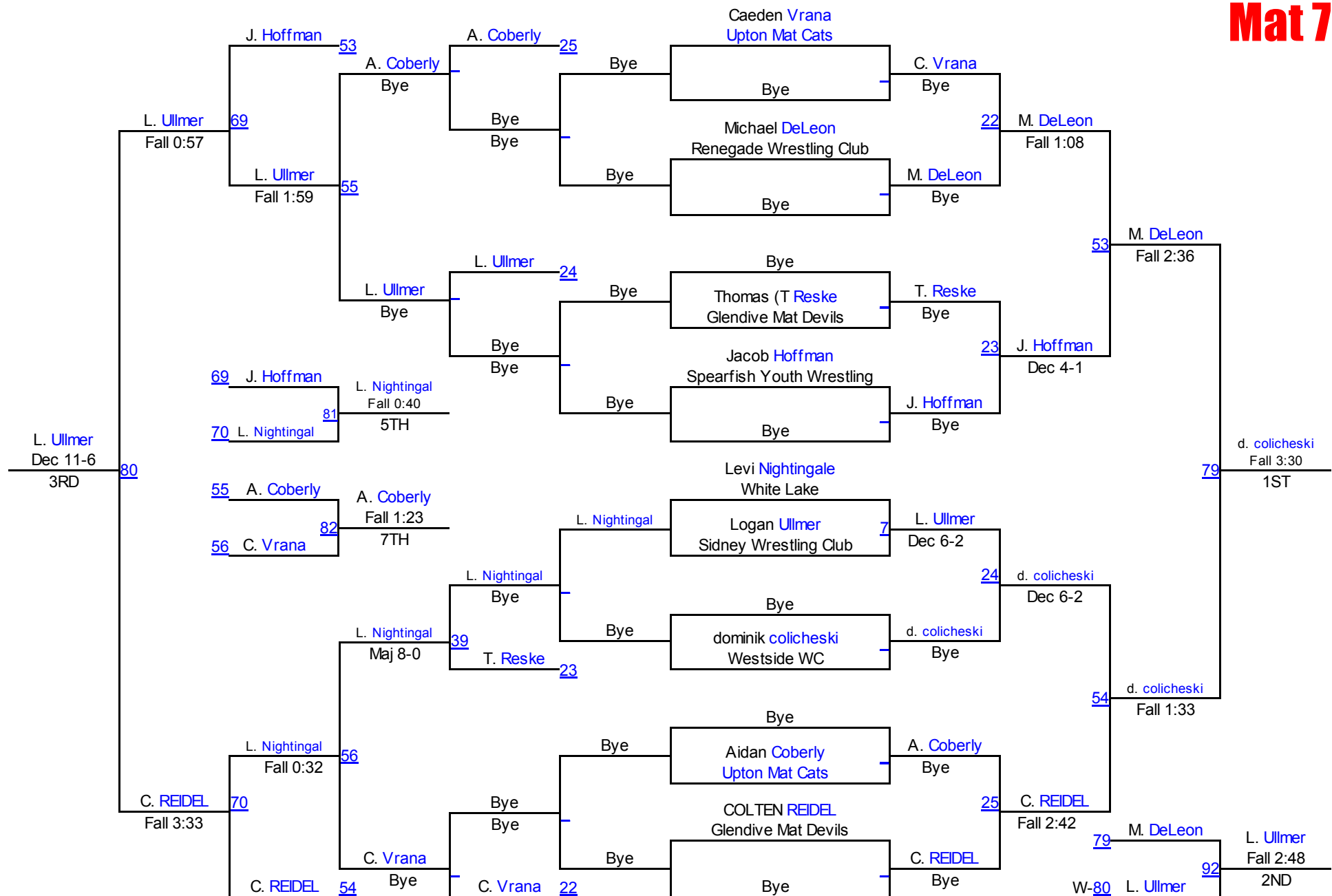

11th Black Hills & AAU Folk. Nationals

Midget 90 Mat 6

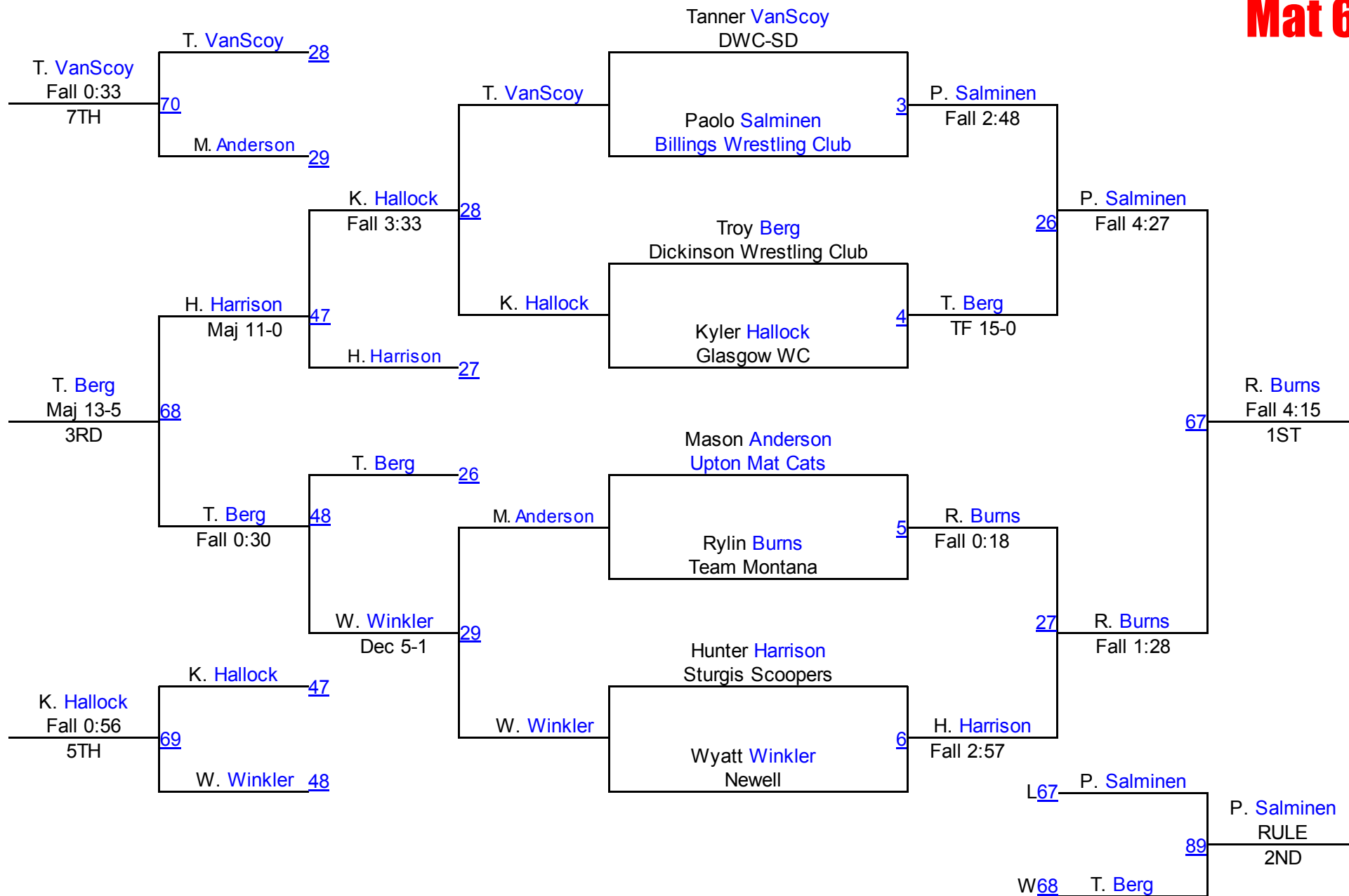

11th Black Hills & AAU Folk. Nationals

Midget 95 Mat 6

Round 1

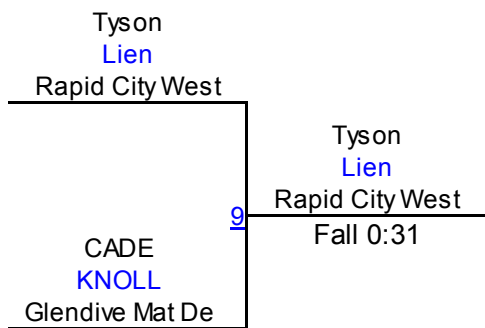

Round 2

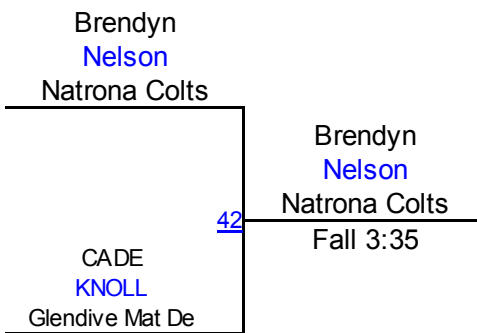

Round 3

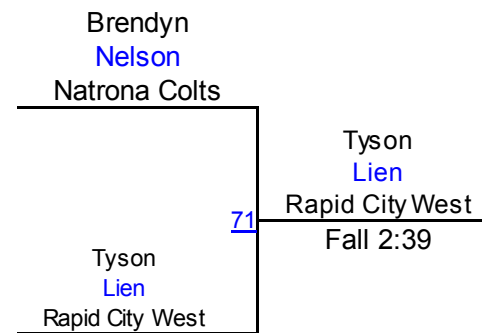

T. Lien (Rapid City Westside)

1ST

B. Nelson (Natrona Colts)

2ND

C. KNOLL (Glendive Mat Devils)

3RD

11th Black Hills & AAU Folk. Nationals

Midget 103 Mat 6

Round 1

Robert Simpson Hardin Wrestlin	Robert Simpson Hardin Wrestlin
Keigan Ingram	
Glasgow WC	
7	Dec 10-3

Peter Pulling Whitewood Wrest	hunter casey Rapid City West
hunter casey	
Rapid City West	
8	Dec 2-0

h. casey (Rapid City Westside)
1ST

Round 2

Jansen Konechne EDGE Wrestling	hunter casey Rapid City West
hunter casey	
Rapid City West	
30	Fall 2:54

Robert Simpson Hardin Wrestlin	Peter Pulling Whitewood Wrest
Peter Pulling	
Whitewood Wrest	
31	Fall 2:40

P. Pulling (Whitewood Wrestling Club)
2ND

Round 3

Jansen Konechne EDGE Wrestling	Peter Pulling Whitewood Wrest
Peter Pulling	
Whitewood Wrest	
49	Dec 7-0

Keigan Ingram Glasgow WC	hunter casey Rapid City West
hunter casey	
Rapid City West	
50	Dec 7-5

R. Simpson (Hardin Wrestling Club)
3RD

Round 4

Jansen Konechne EDGE Wrestling	Keigan Ingram Glasgow WC
Keigan Ingram	
Glasgow WC	
65	Fall 0:28

Robert Simpson Hardin Wrestlin	hunter casey Rapid City West
hunter casey	
Rapid City West	
66	Dec 4-2

K. Ingram (Glasgow WC)
4TH

Round 5

Jansen Konechne EDGE Wrestling	Robert Simpson Hardin Wrestlin
Robert Simpson	
Hardin Wrestlin	
87	Maj 10-0

Keigan Ingram Glasgow WC	Peter Pulling Whitewood Wrest
Peter Pulling	
Whitewood Wrest	
88	Dec 6-4

J. Konechne (EDGE Wrestling Club)
5TH

11th Black Hills & AAU Folk. Nationals

Midget 112 Mat 6

Round 1

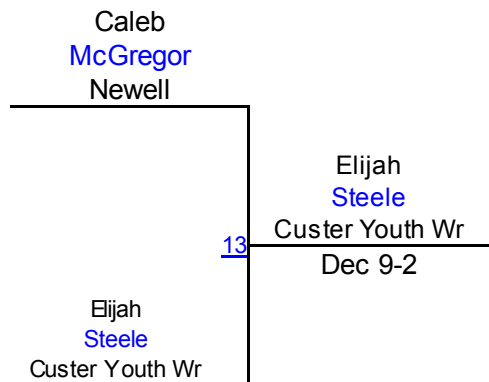

Round 2

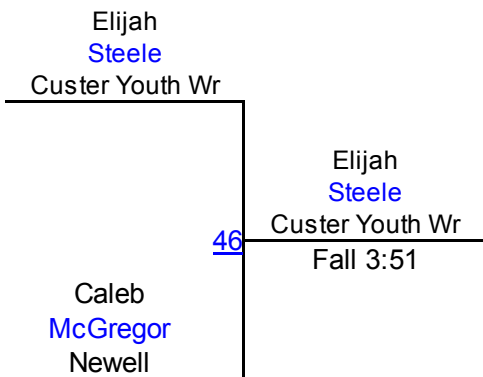

Round 3

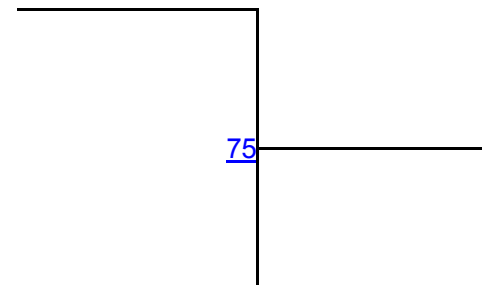

E. Steele (Custer Youth Wrestling)

1ST

C. McGregor (Newell)

2ND

11th Black Hills & AAU Folk. Nationals

Midget 120 Mat 6

Round 1

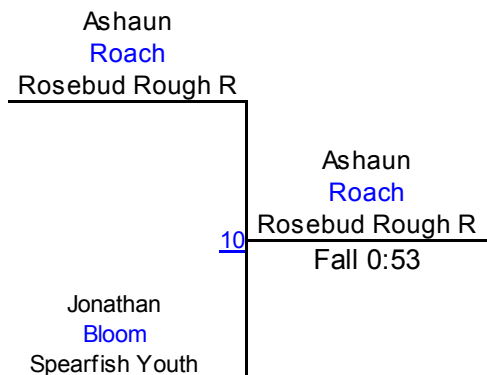

Round 2

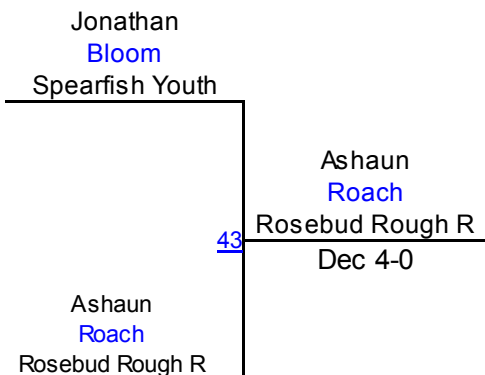

Round 3

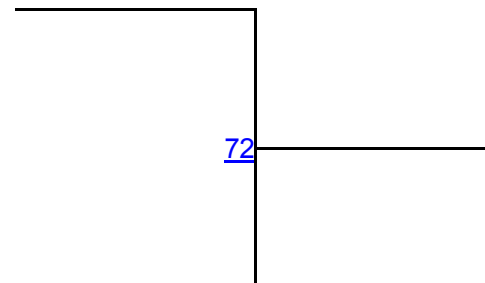

A. Roach (Rosebud Rough Riders)
1ST

J. Bloom (Spearfish Youth Wrestling)
2ND

11th Black Hills & AAU Folk. Nationals

Novice 65 Mat 3

Round 1

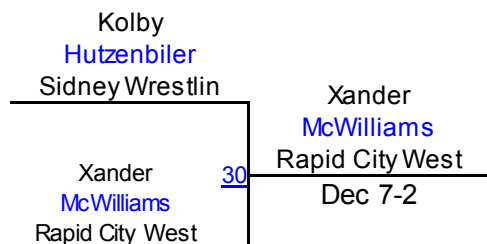
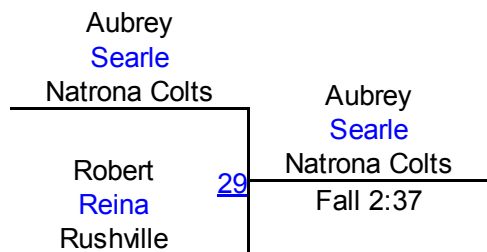

Round 2

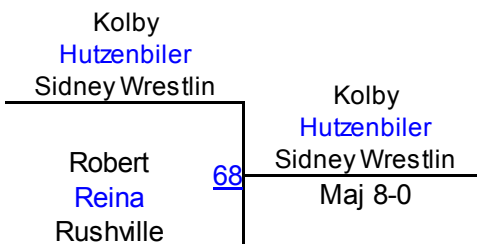
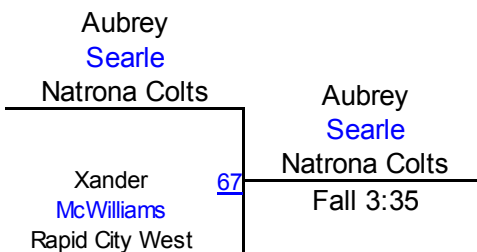

Round 3

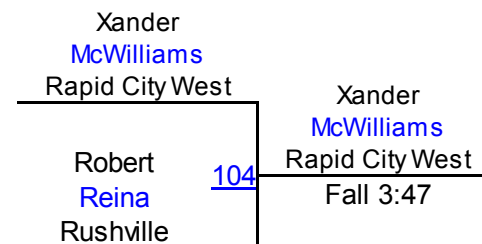
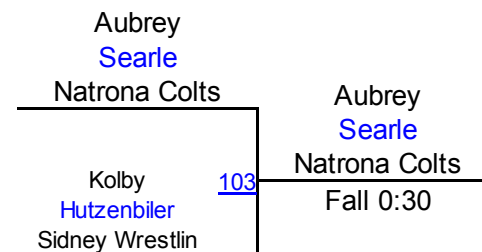

- A. Searle (Natrona Colts)
1ST
- X. McWilliams (Rapid City Westside)
2ND
- K. Hutzenbiler (Sidney Wrestling Club)
3RD
- R. Reina (Rushville)
4TH

11th Black Hills & AAU Folk. Nationals

Novice 70 Mat 3



11th Black Hills & AAU Folk. Nationals

Novice 75 Mat 3

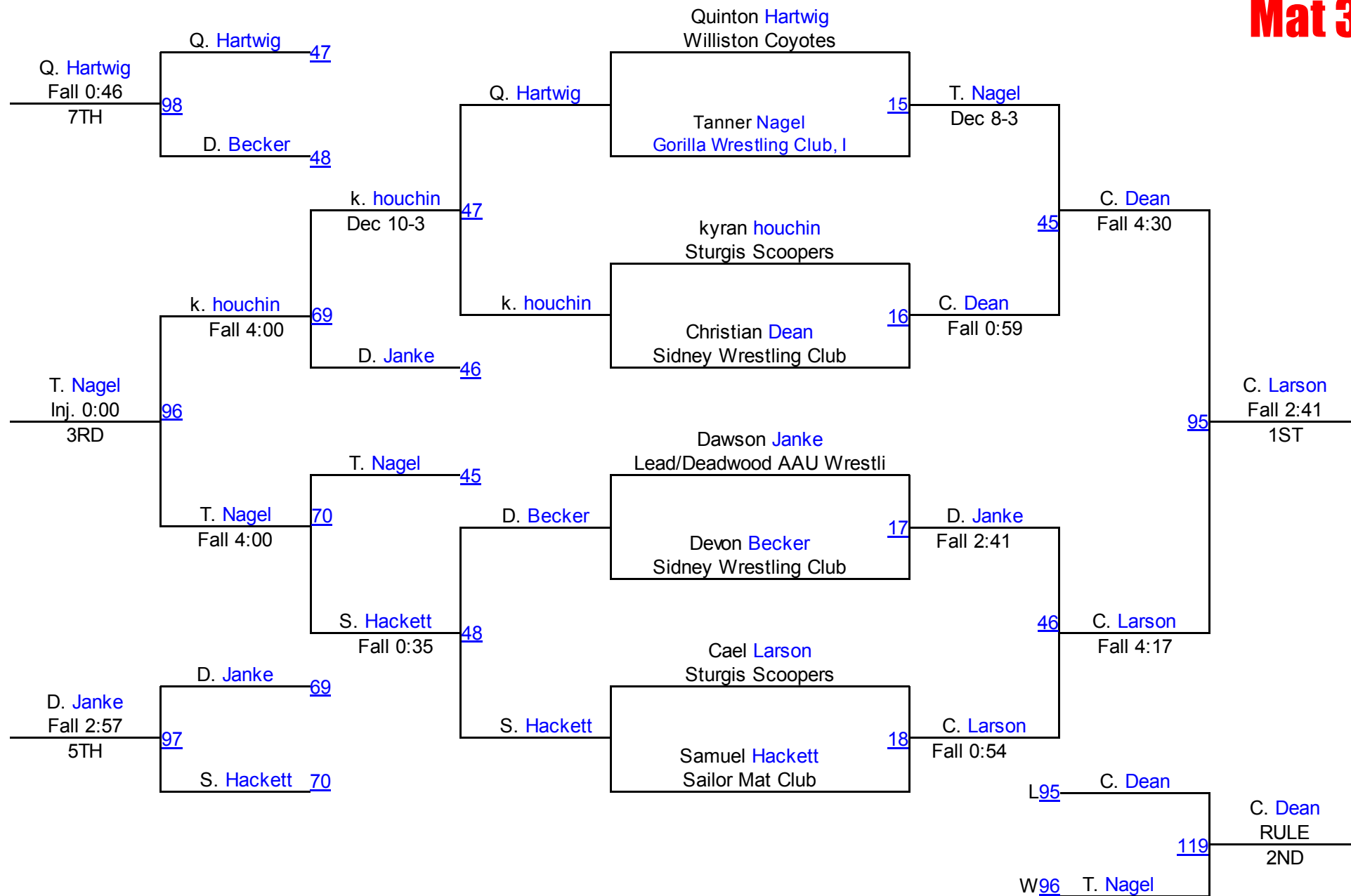

11th Black Hills & AAU Folk. Nationals

Novice 80 Mat 3

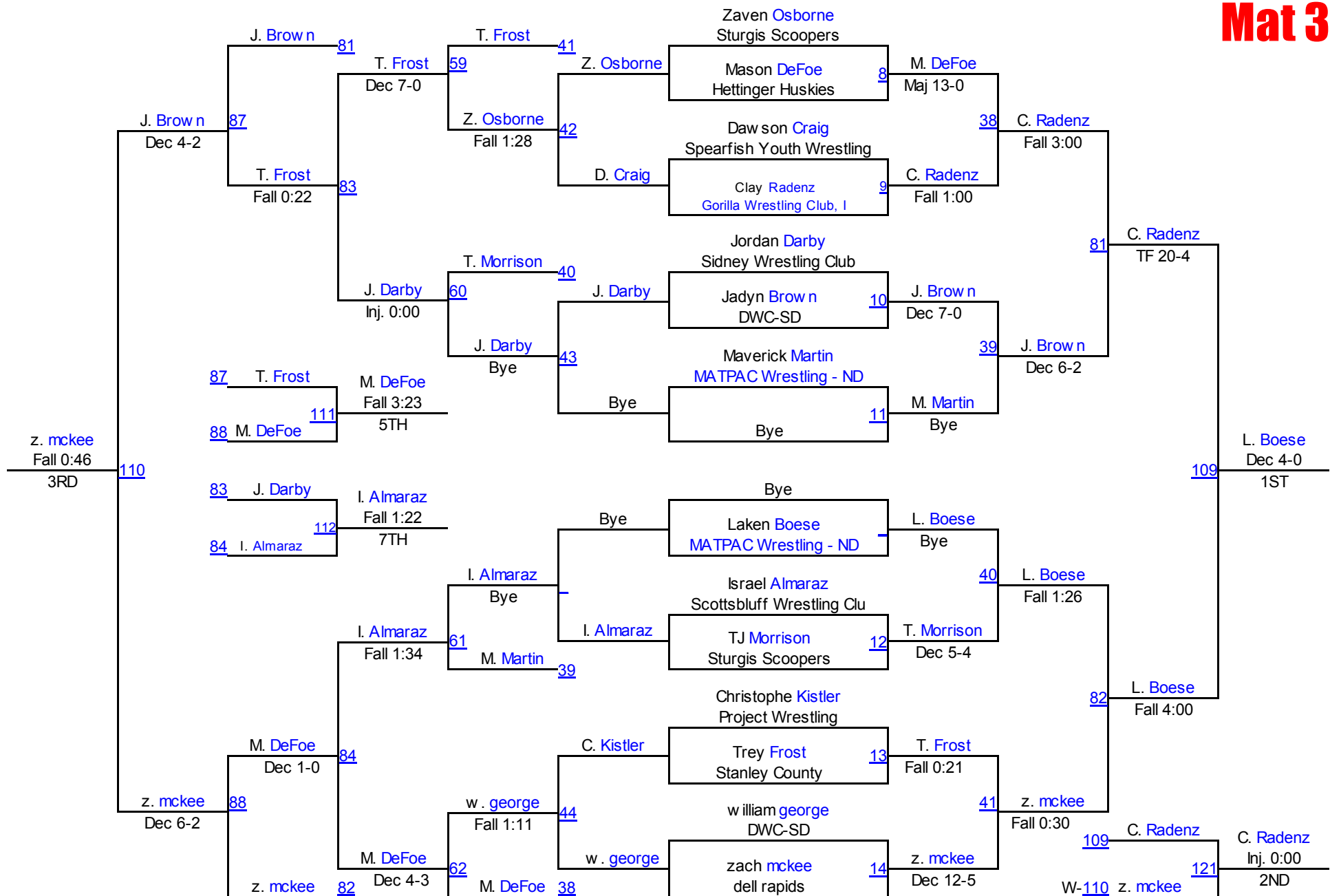

11th Black Hills & AAU Folk. Nationals

Novice 85 Mat 4

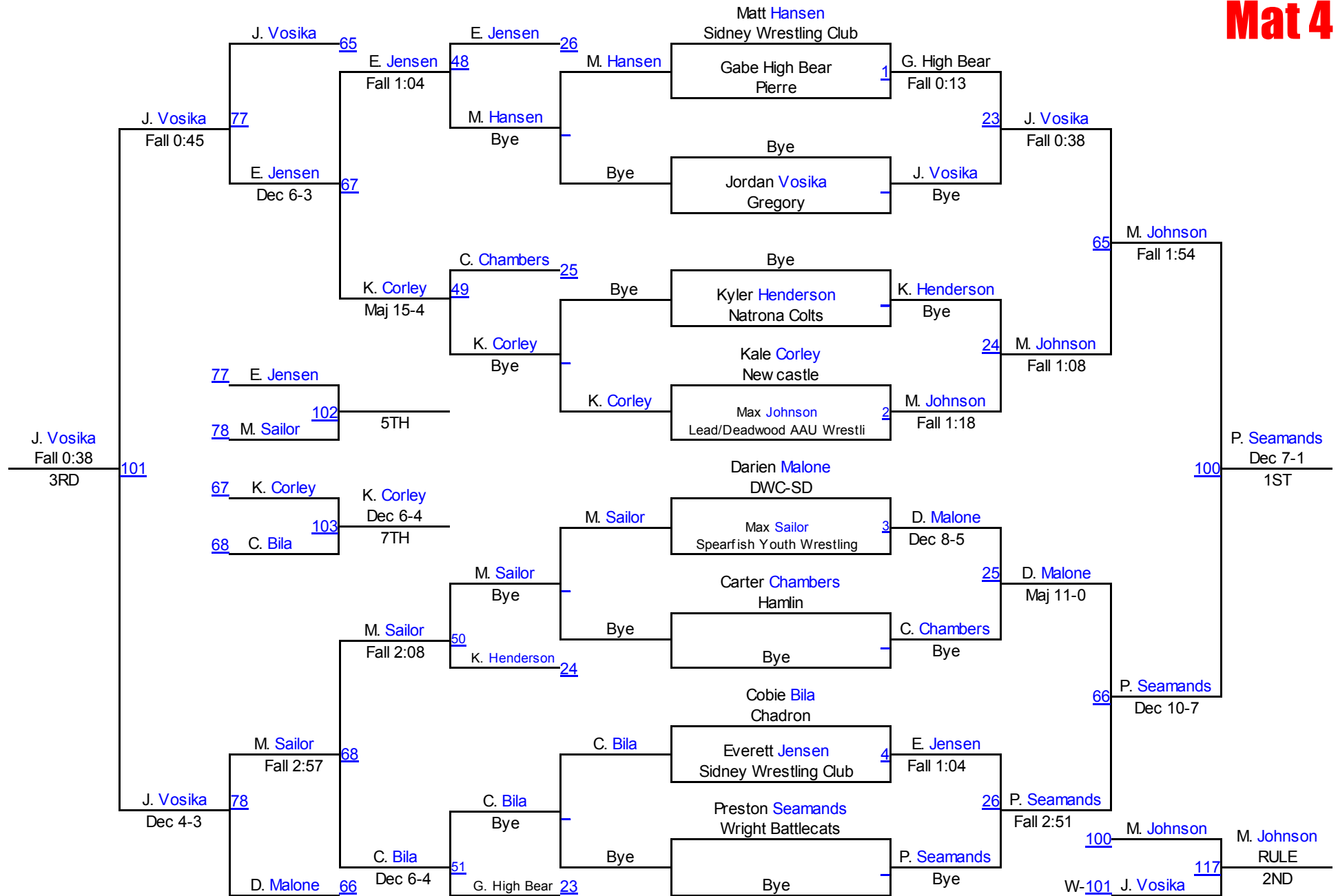

11th Black Hills & AAU Folk. Nationals

Novice 90 Mat 4

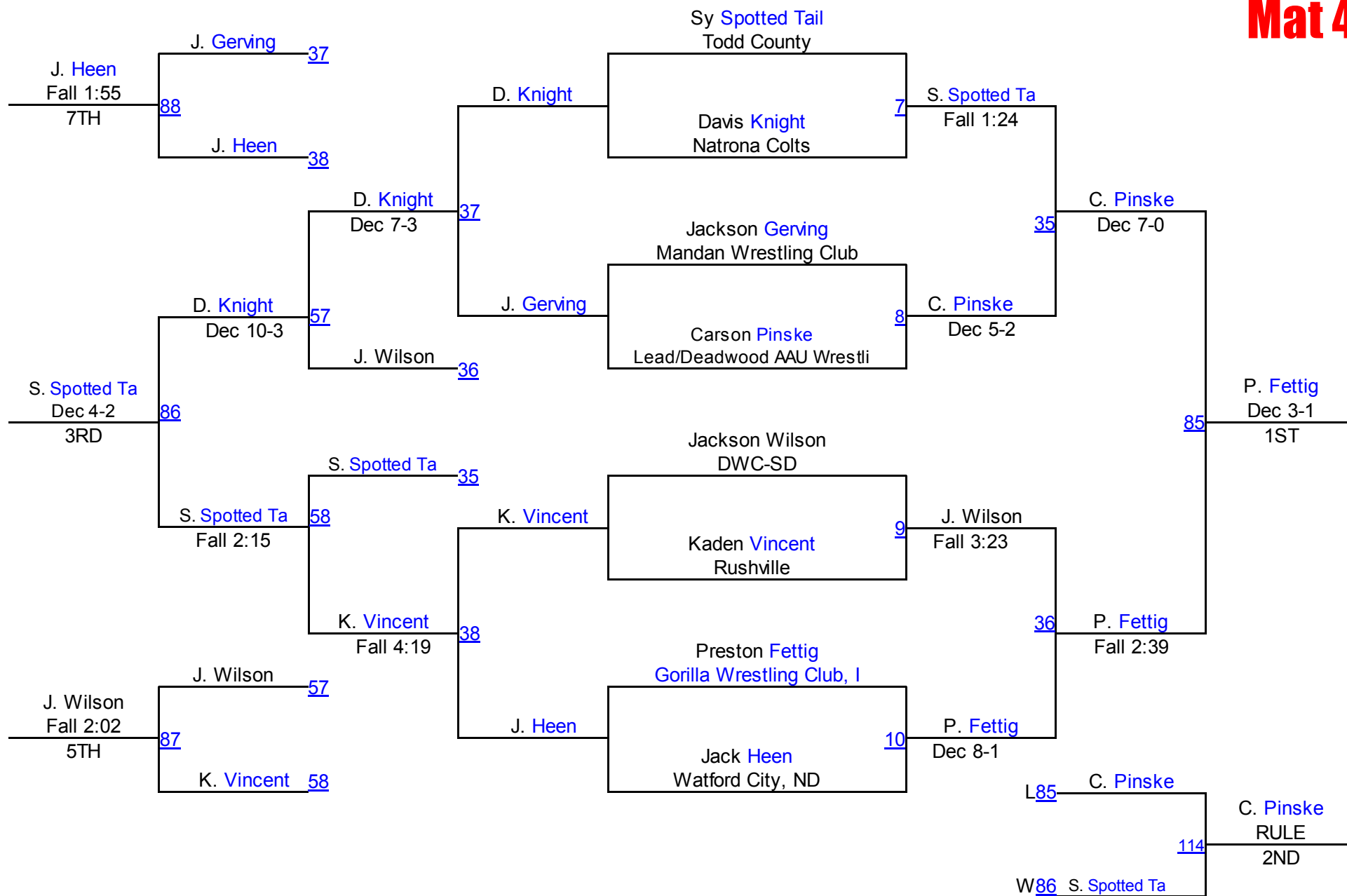

11th Black Hills & AAU Folk. Nationals

Novice 95 Mat 4

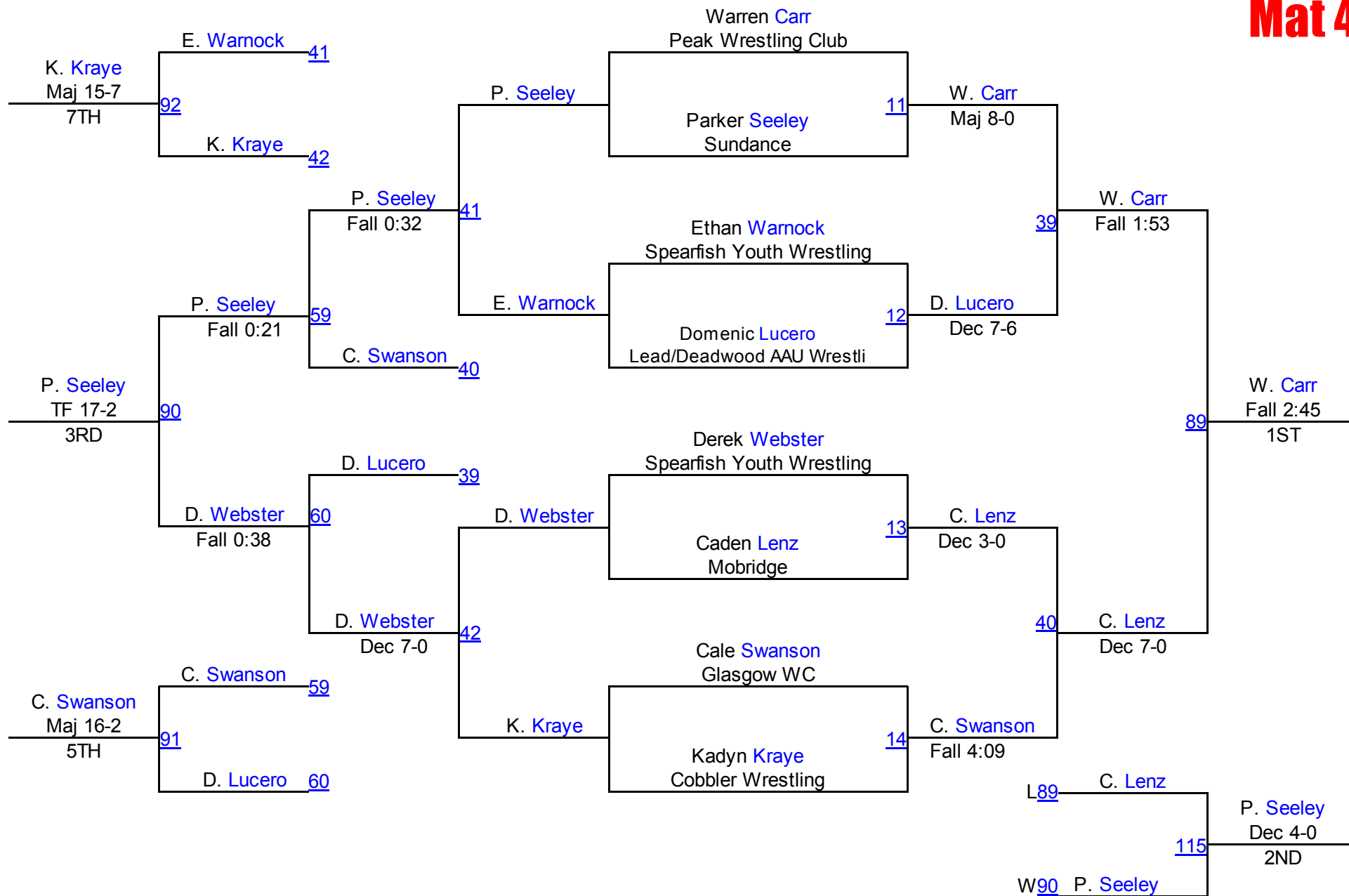

11th Black Hills & AAU Folk. Nationals

Novice 100 Mat 3

Round 1

Joshua Deaguero Adams City Wres	Joshua Deaguero Adams City Wres
parker scheier 23	Maj 9-0
MCM Wrestling	

Coy Cohenour Team Montana	Riley Waters Sidney Wrestlin
Riley Waters 24	Fall 2:23
Sidney Wrestlin	

J. Deaguero (Adams City Wrestling)
1ST

Round 2

Riley Martin MATPAC Wrestlin	Riley Waters Sidney Wrestlin
Riley Waters 53	Fall 3:40
Sidney Wrestlin	

Joshua Deaguero Adams City Wres	Joshua Deaguero Adams City Wres
Coy Cohenour 54	Fall 1:02
Team Montana	

p. scheier (MCM Wrestling)
2ND

Round 3

Riley Martin MATPAC Wrestlin	Coy Cohenour Team Montana
Coy Cohenour 75	Dec 14-7
Team Montana	

parker scheier MCM Wrestling	parker scheier MCM Wrestling
Riley Waters 76	TF 15-0
Sidney Wrestlin	

R. Waters (Sidney Wrestling Club)
3RD

Round 4

Riley Martin MATPAC Wrestlin	parker scheier MCM Wrestling
parker scheier 93	TF 19-0
MCM Wrestling	

Joshua Deaguero Adams City Wres	Joshua Deaguero Adams City Wres
Riley Waters 94	Fall 1:13
Sidney Wrestlin	

C. Cohenour (Team Montana)
4TH

Round 5

Riley Martin MATPAC Wrestlin	Joshua Deaguero Adams City Wres
Joshua Deaguero 117	TF 15-0
Adams City Wres	

parker scheier MCM Wrestling	parker scheier MCM Wrestling
Coy Cohenour 118	Fall 2:06
Team Montana	

R. Martin (MATPAC Wrestling - ND)
5TH

11th Black Hills & AAU Folk. Nationals

Novice 105 Mat 4

Round 1

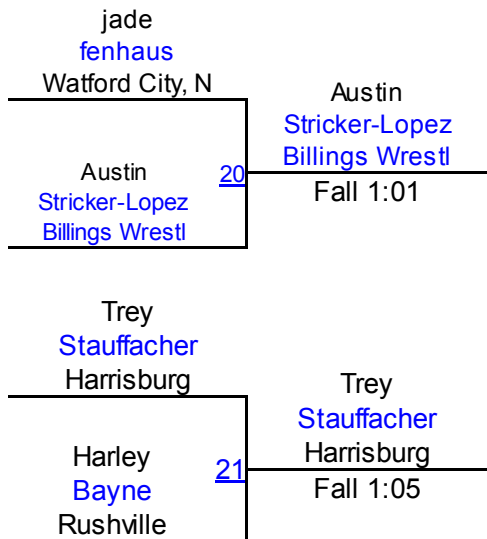

Round 2

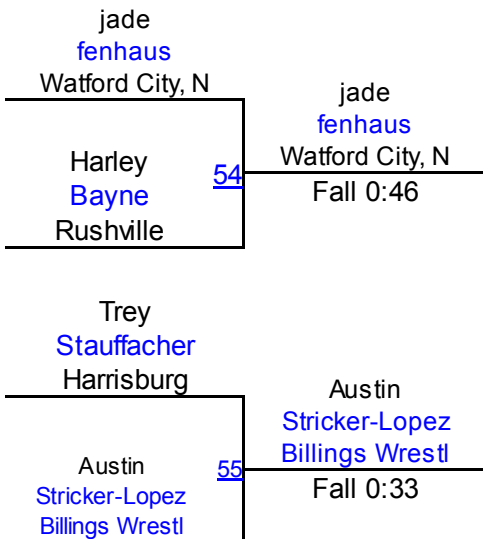

Round 3

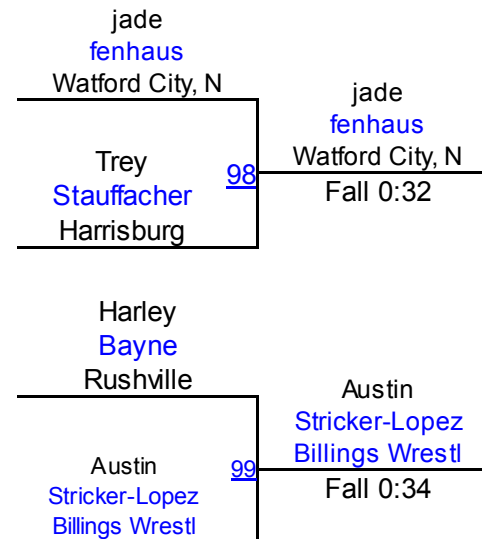

- A. Stricker-Lopez (Billings Wrestling Club)
1ST
- j. fenhaus (Watford City, ND)
2ND
- T. Stauffacher (Harrisburg)
3RD
- H. Bayne (Rushville)
4TH

11th Black Hills & AAU Folk. Nationals

Novice 112 Mat 4

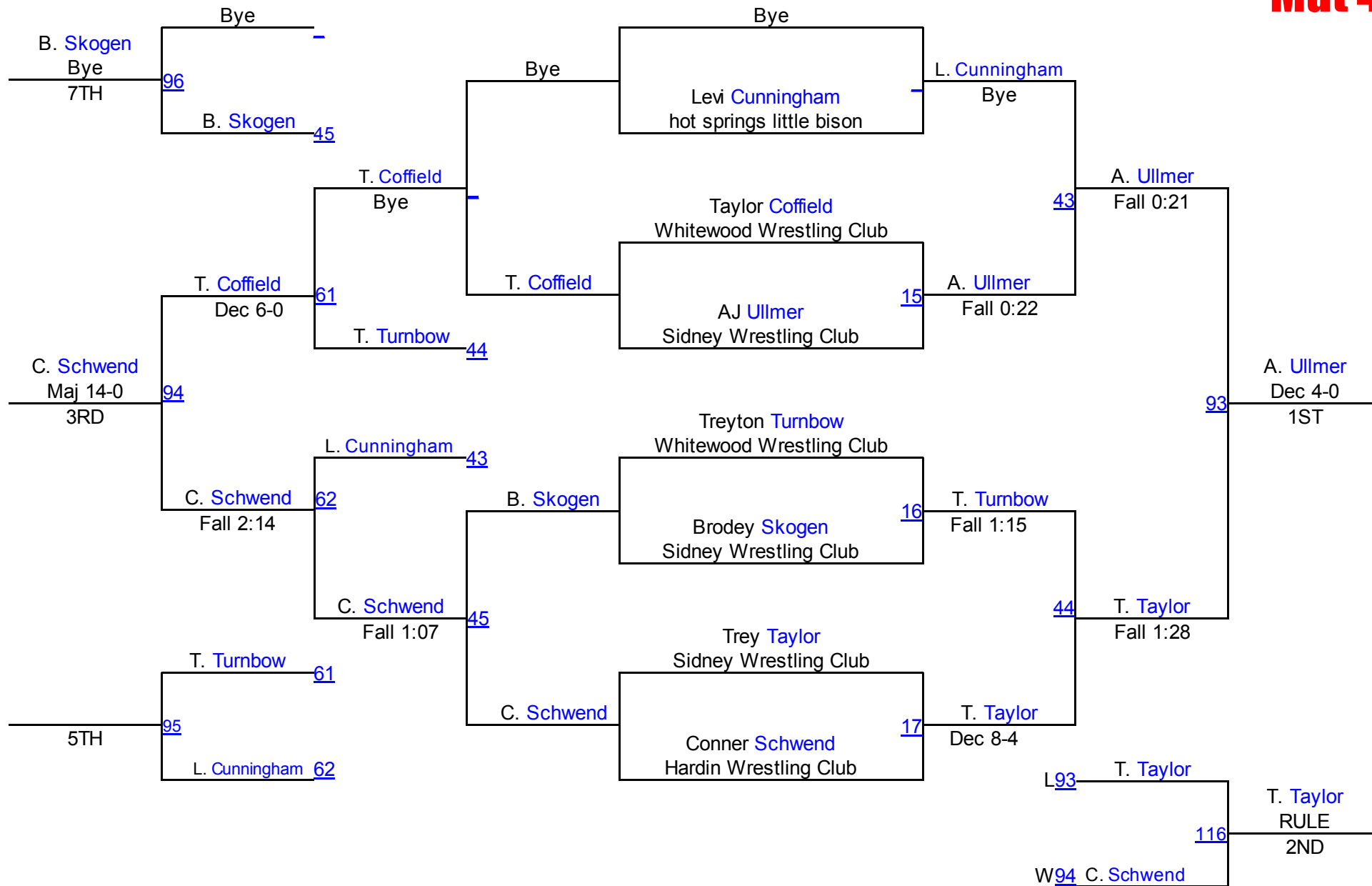

11th Black Hills & AAU Folk. Nationals

Novice 120 Mat 4

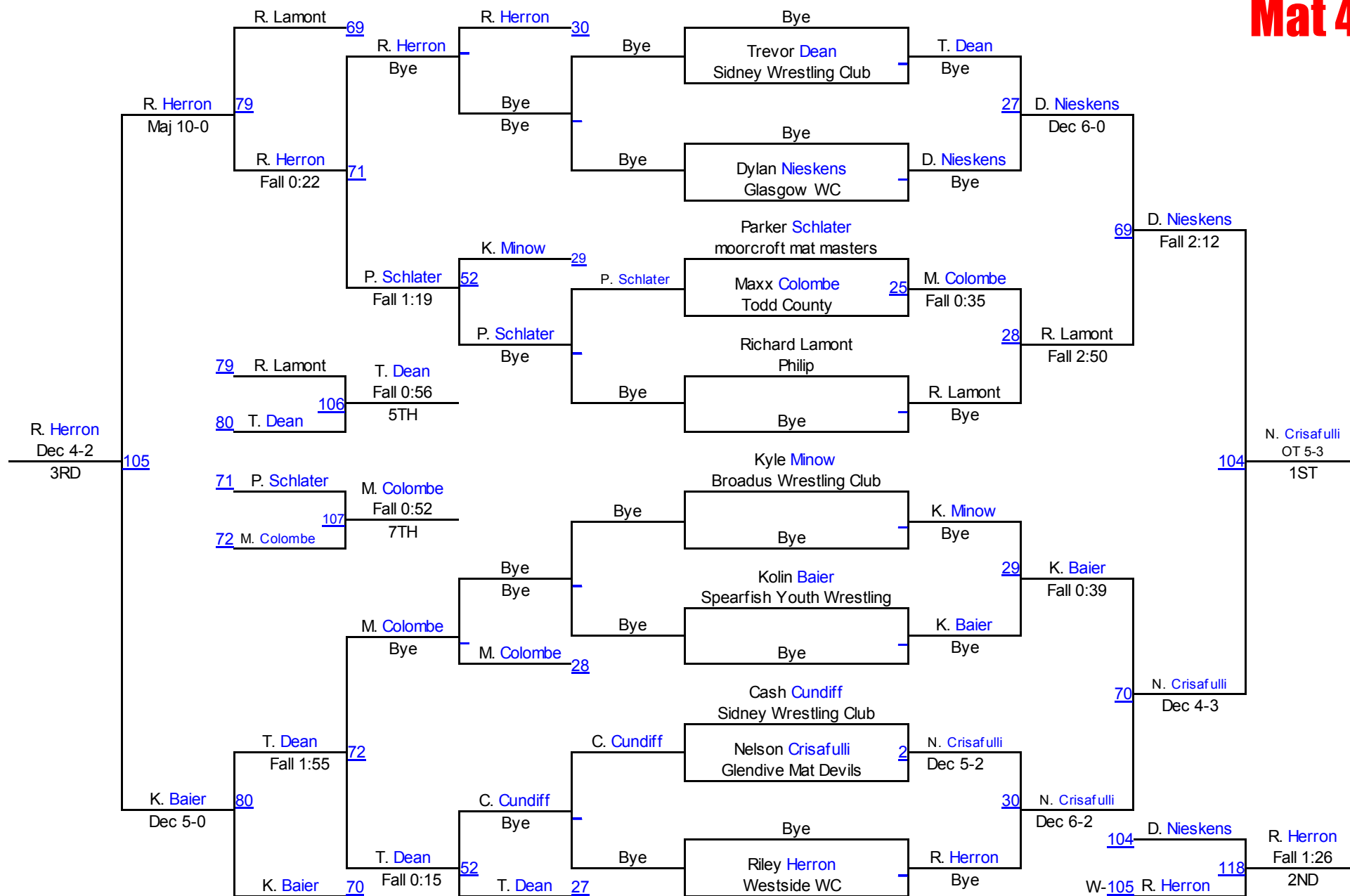

11th Black Hills & AAU Folk. Nationals

Novice 130 Mat 4

Round 1

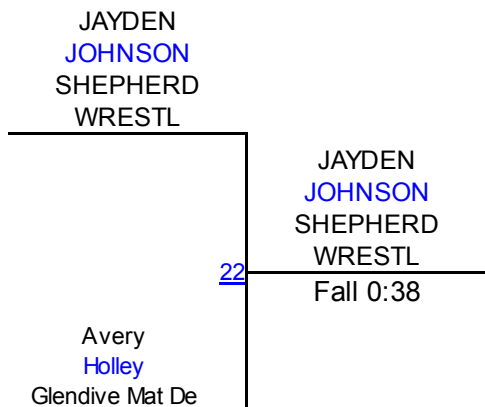

Round 2

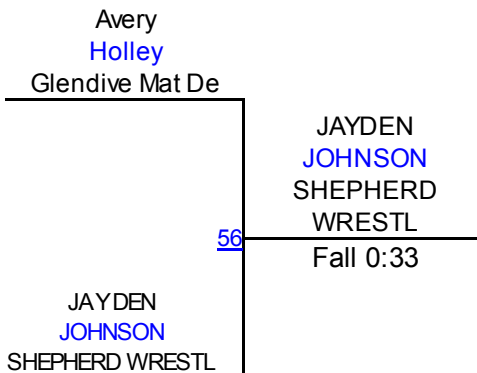

Round 3

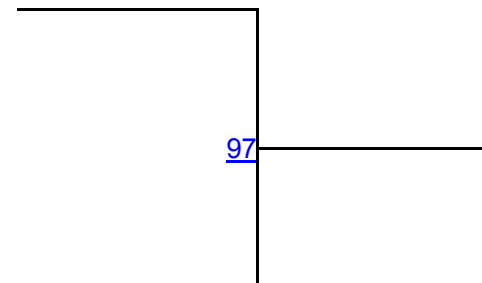

J. JOHNSON (SHEPHERD WRESTLING CLUB)
1ST

A. Holley (Glendive Mat Devils)
2ND

11th Black Hills & AAU Folk. Nationals

Novice 140 Mat 4

Round 1

Trevor Ellis Yankton	Trevor Ellis Yankton
Ty Kittleson 18 Glasgow WC	Fall 0:21

Trey Schepens Sidney Wrestlin	Tel Aune Glasgow WC
Tel Aune 19 Glasgow WC	Fall 3:38

T. Ellis (Yankton)
1ST

Round 2

Kyen Young Renegade Wrestl	Kyen Young Renegade Wrestl
Tel Aune 46 Glasgow WC	Fall 2:27

Trevor Ellis Yankton	Trevor Ellis Yankton
Trey Schepens 47 Sidney Wrestlin	Fall 0:35

K. Young (Renegade Wrestling Club)
2ND

Round 3

Kyen Young Renegade Wrestl	Kyen Young Renegade Wrestl
Trey Schepens 63 Sidney Wrestlin	Fall 2:22

Ty Kittleson Glasgow WC	Tel Aune Glasgow WC
Tel Aune 64 Glasgow WC	Fall 3:58

T. Aune (Glasgow WC)
3RD

Round 4

Kyen Young Renegade Wrestl	Kyen Young Renegade Wrestl
Ty Kittleson 83 Glasgow WC	Fall 0:38

Trevor Ellis Yankton	Trevor Ellis Yankton
Tel Aune 84 Glasgow WC	Fall 1:46

T. Schepens (Sidney Wrestling Club)
4TH

Round 5

Kyen Young Renegade Wrestl	Trevor Ellis Yankton
Trevor Ellis 112 Yankton	Fall 2:53

Ty Kittleson Glasgow WC	Trey Schepens Sidney Wrestlin
Trey Schepens 113 Sidney Wrestlin	Fall 2:09

T. Kittleson (Glasgow WC)
5TH

11th Black Hills & AAU Folk. Nationals

Novice Hwt Mat 4

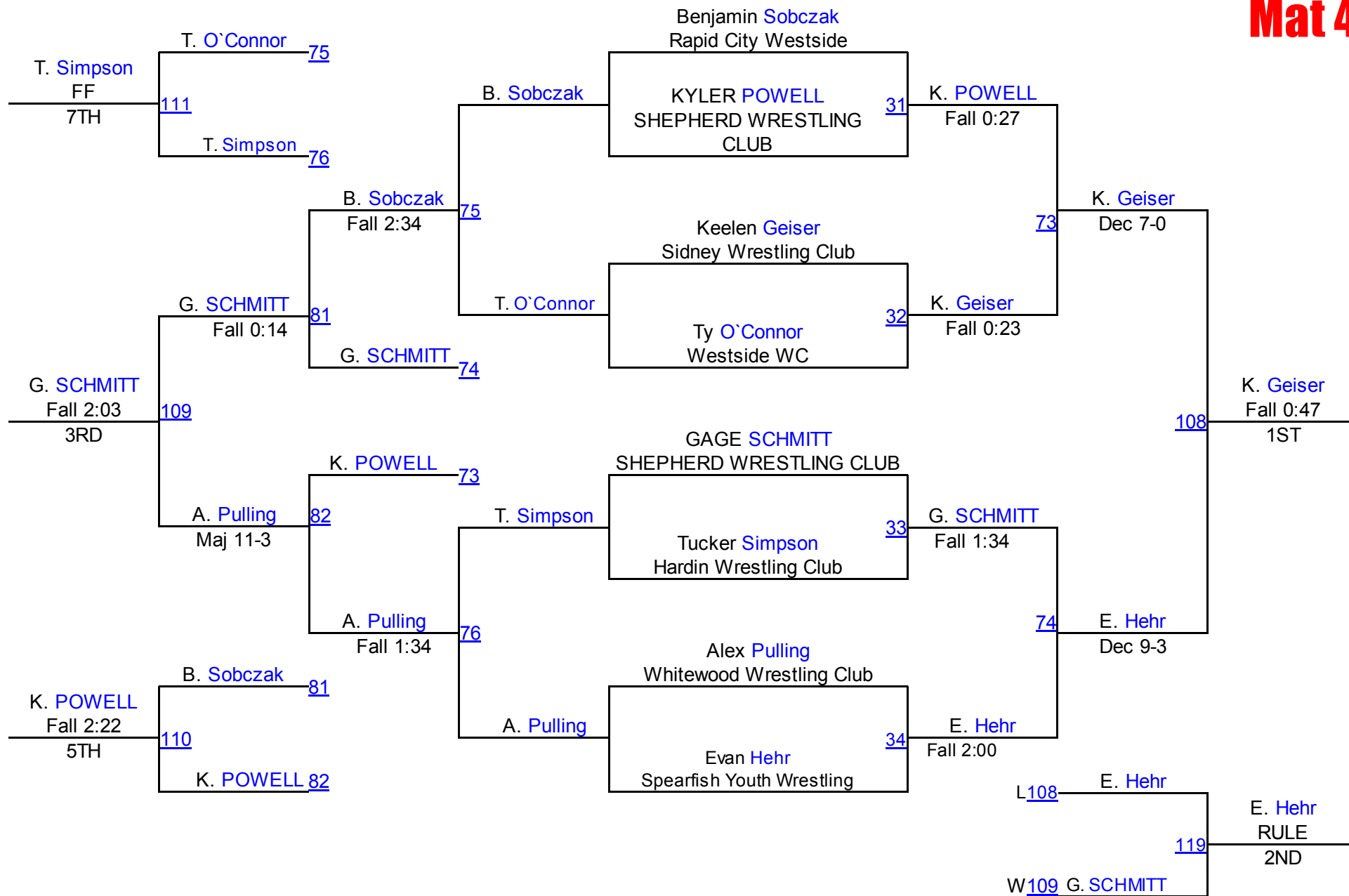

11th Black Hills & AAU Folk. Nationals

Schoolboy 75/80 Mat 6

Round 1

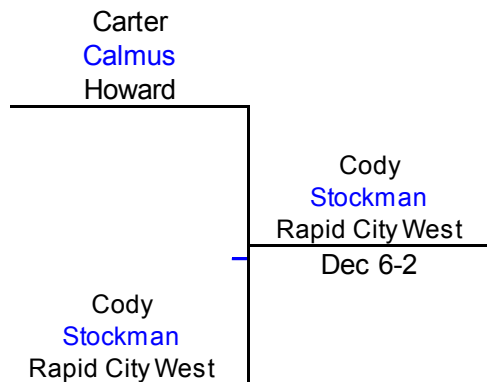

Cody
Stockman
Rapid City West
Dec 6-2

Round 2

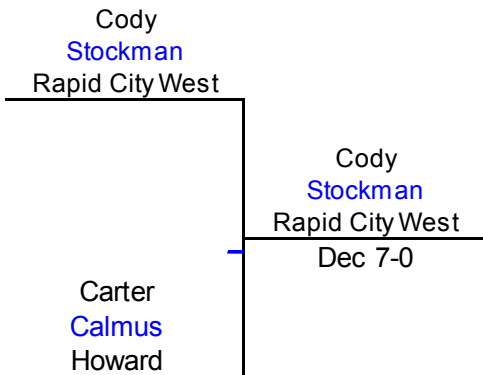

Cody
Stockman
Rapid City West
Dec 7-0

Round 3

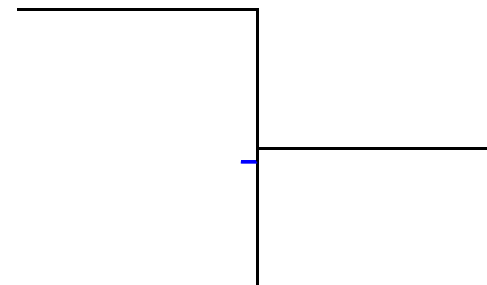

C. Stockman (Rapid City Westside)
1ST

C. Calmus (Howard)
2ND

11th Black Hills & AAU Folk. Nationals

Schoolboy 85 Mat 6

Round 1

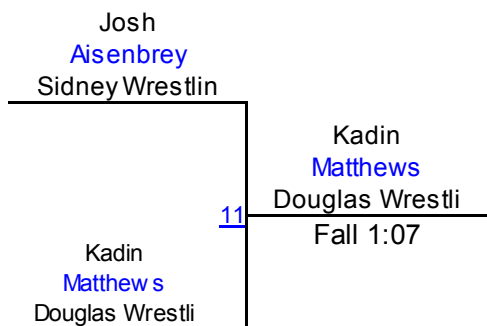

Round 2

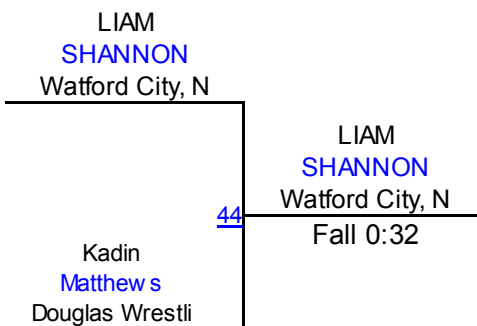

Round 3

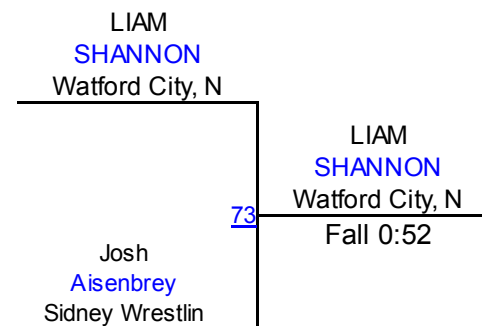

L. SHANNON (Watford City, ND)
1ST

K. Matthews (Douglas Wrestling Club -)
2ND

J. Aisenbrey (Sidney Wrestling Club)
3RD

11th Black Hills & AAU Folk. Nationals

Schoolboy 90 Mat 6

Round 1

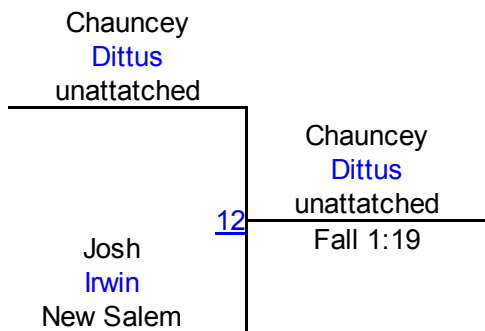

Round 2

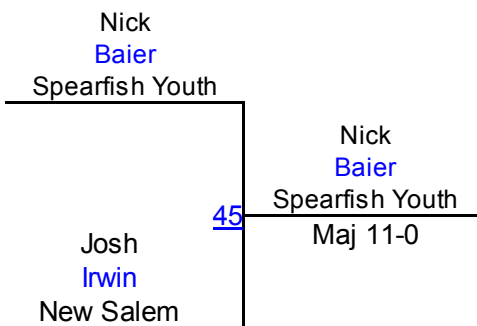

Round 3

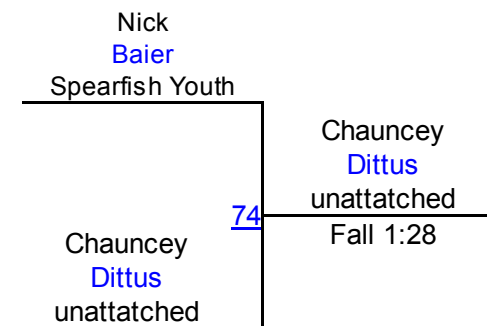

C. **Dittus** (unattached)
1ST

N. **Baier** (Spearfish Youth Wrestling)
2ND

J. **Irwin** (New Salem)
3RD

11th Black Hills & AAU Folk. Nationals

Schoolboy 95 Mat 7

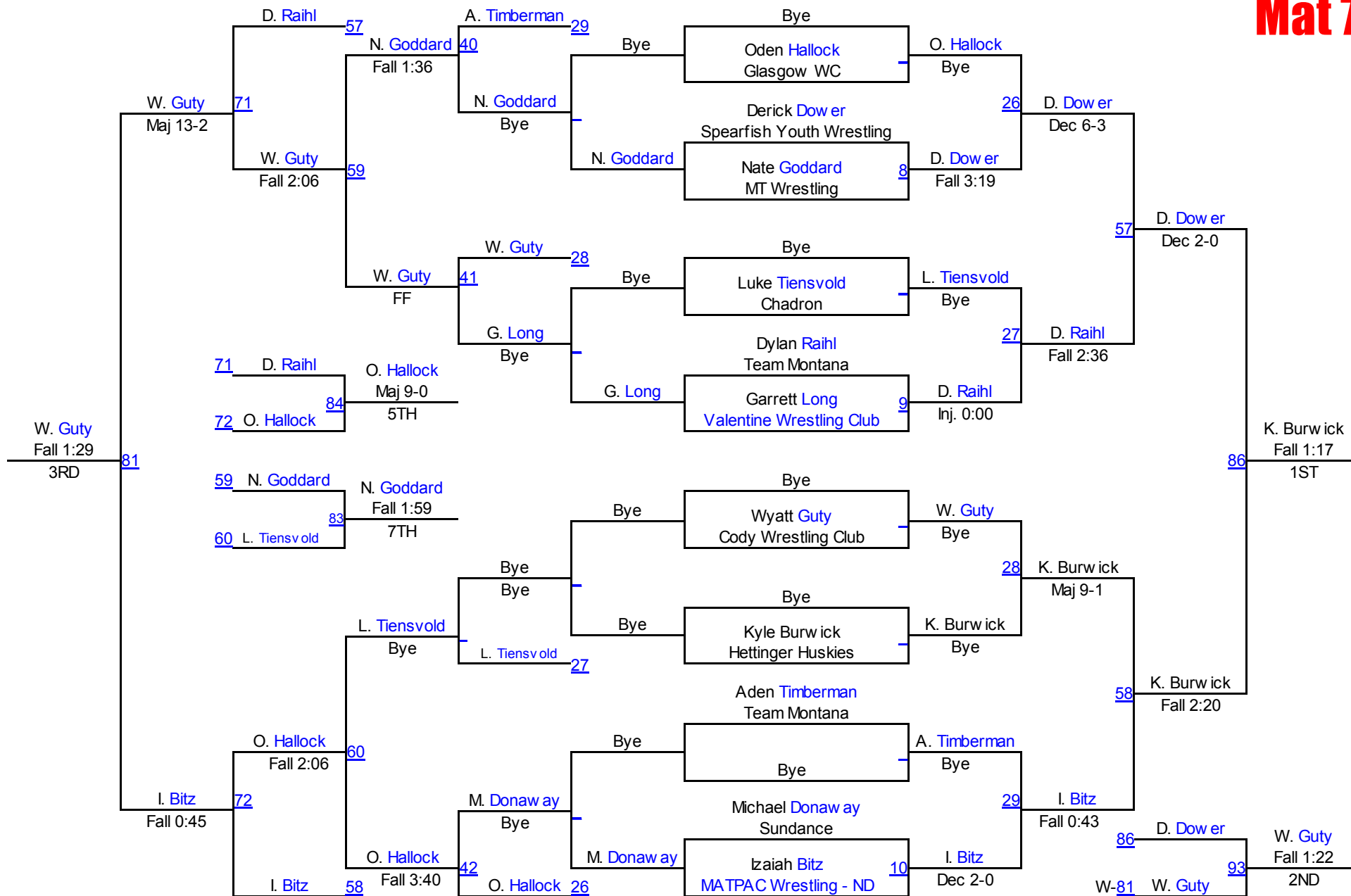

11th Black Hills & AAU Folk. Nationals

Schoolboy 100 Mat 8

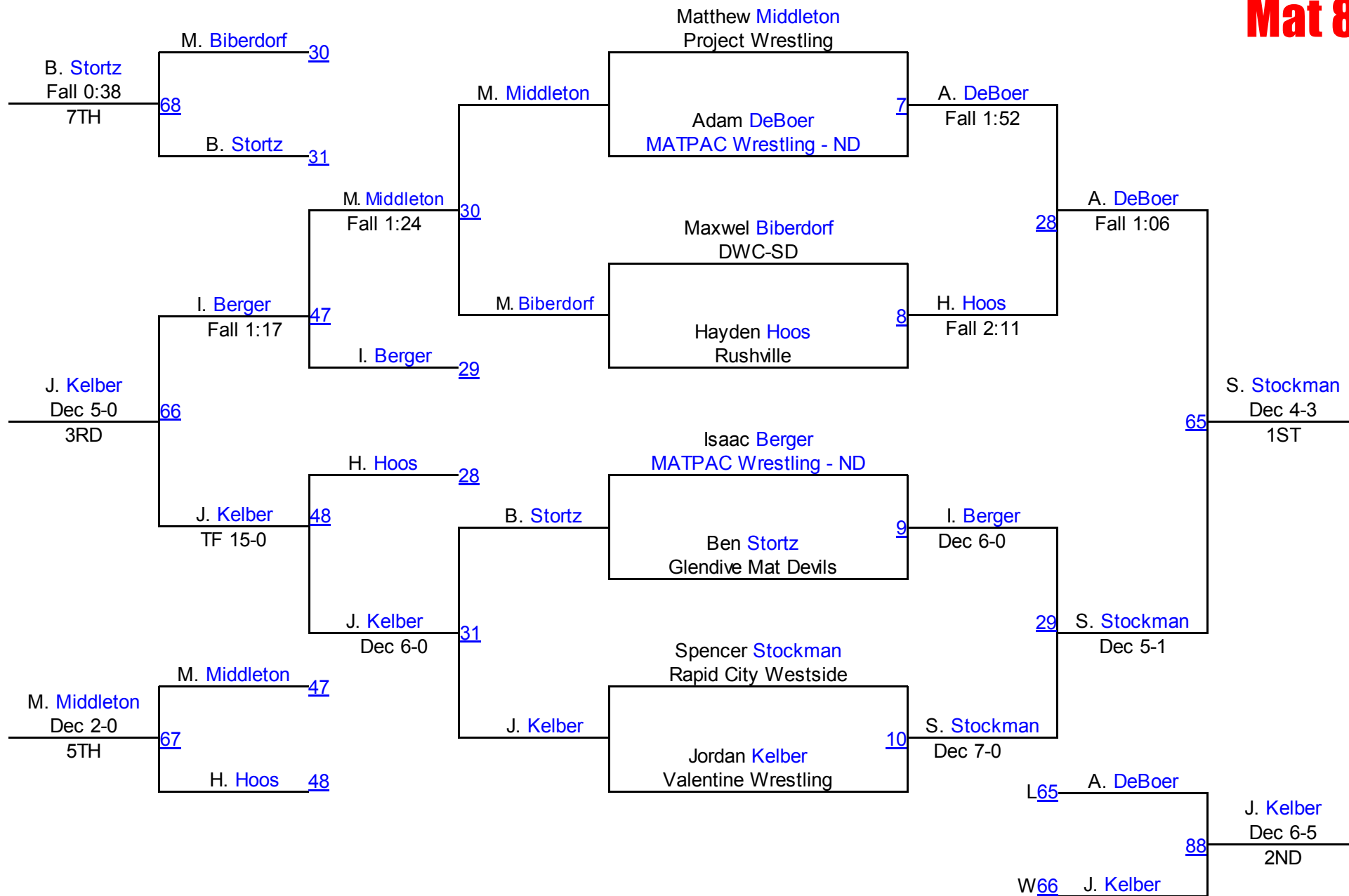

11th Black Hills & AAU Folk. Nationals

Schoolboy 105 Mat 8

Round 1

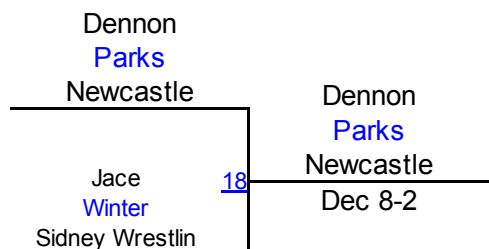
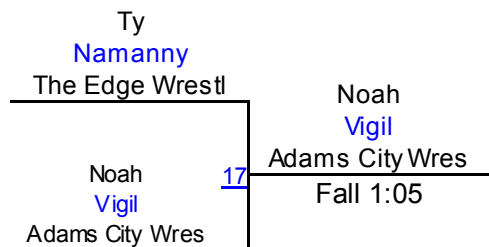

Round 2

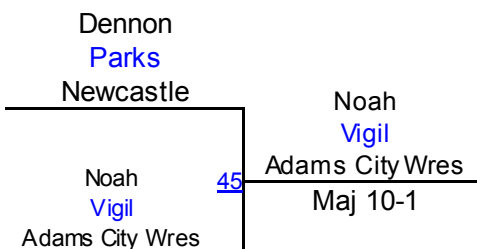
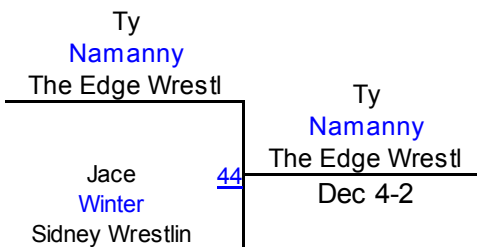

Round 3

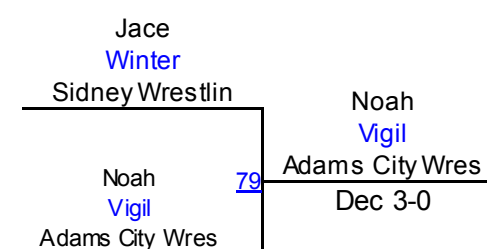
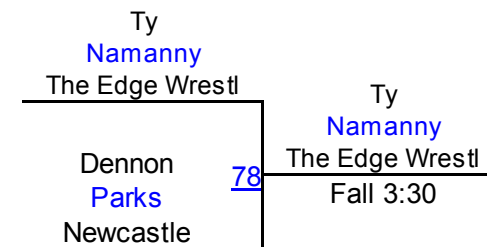

N. **Vigil** (Adams City Wrestling)
1ST

T. **Namanny** (The Edge Wrestling Club)
2ND

D. **Parks** (Newcastle)
3RD

J. **Winter** (Sidney Wrestling Club)
4TH

11th Black Hills & AAU Folk. Nationals

Schoolboy 110 Mat 8

Round 1

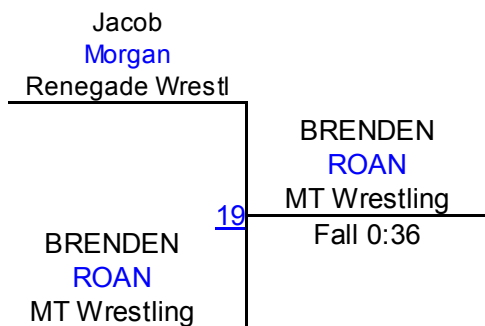

Round 2

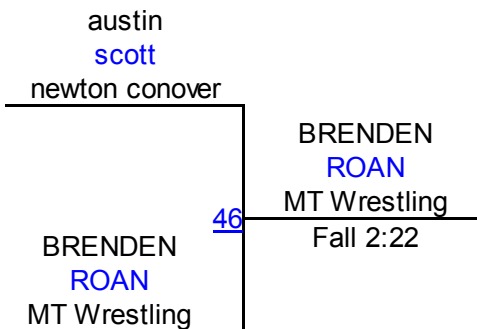

Round 3

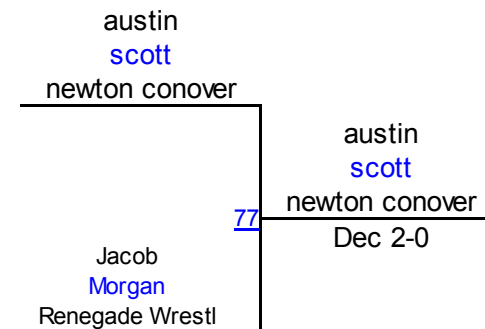

B. ROAN (MT Wrestling)
1ST

a. scott (newton conover middle)
2ND

J. Morgan (Renegade Wrestling Club)
3RD

11th Black Hills & AAU Folk. Nationals

Schoolboy 115 Mat 7

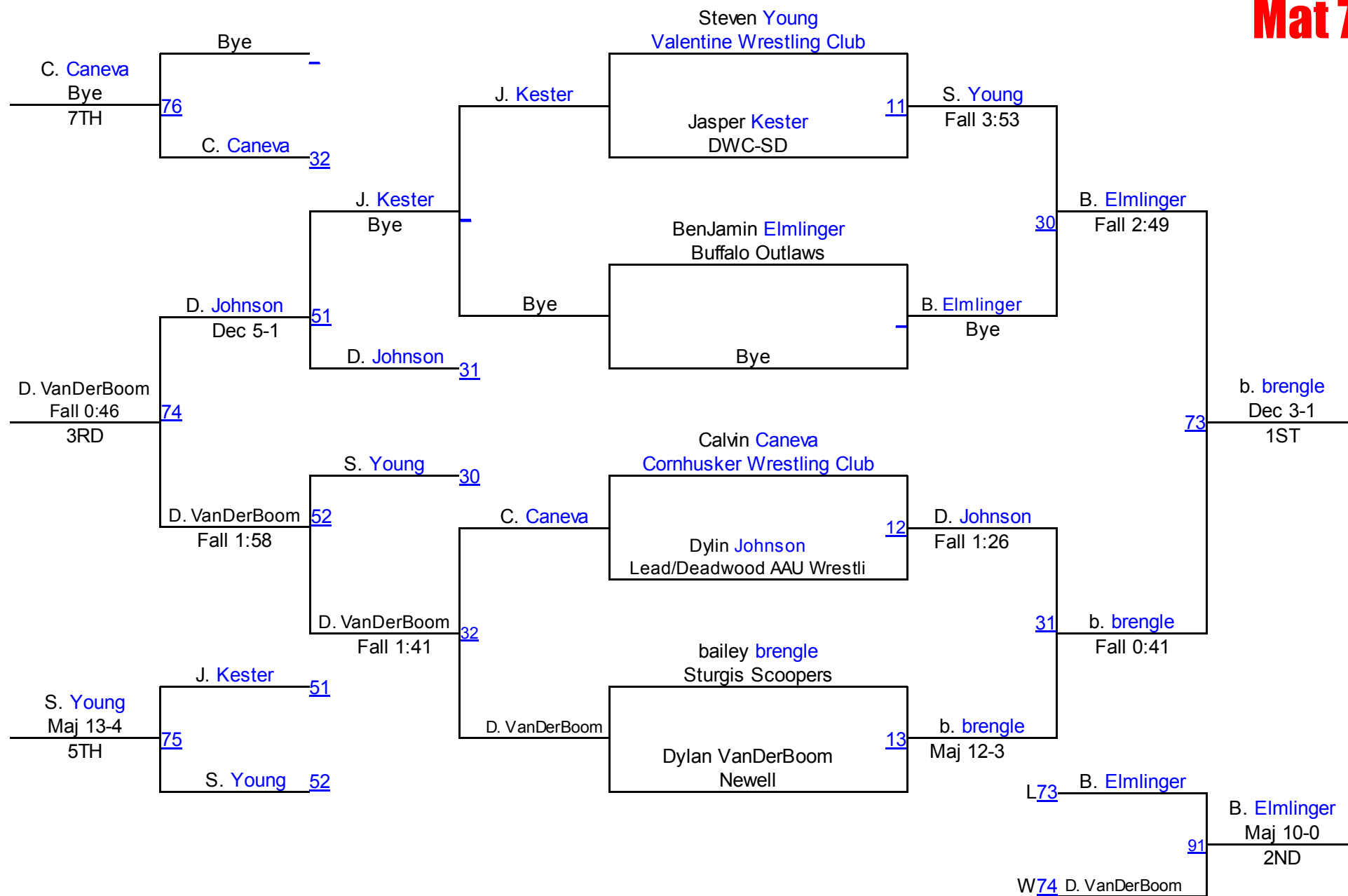

11th Black Hills & AAU Folk. Nationals

Schoolboy 120 Mat 8

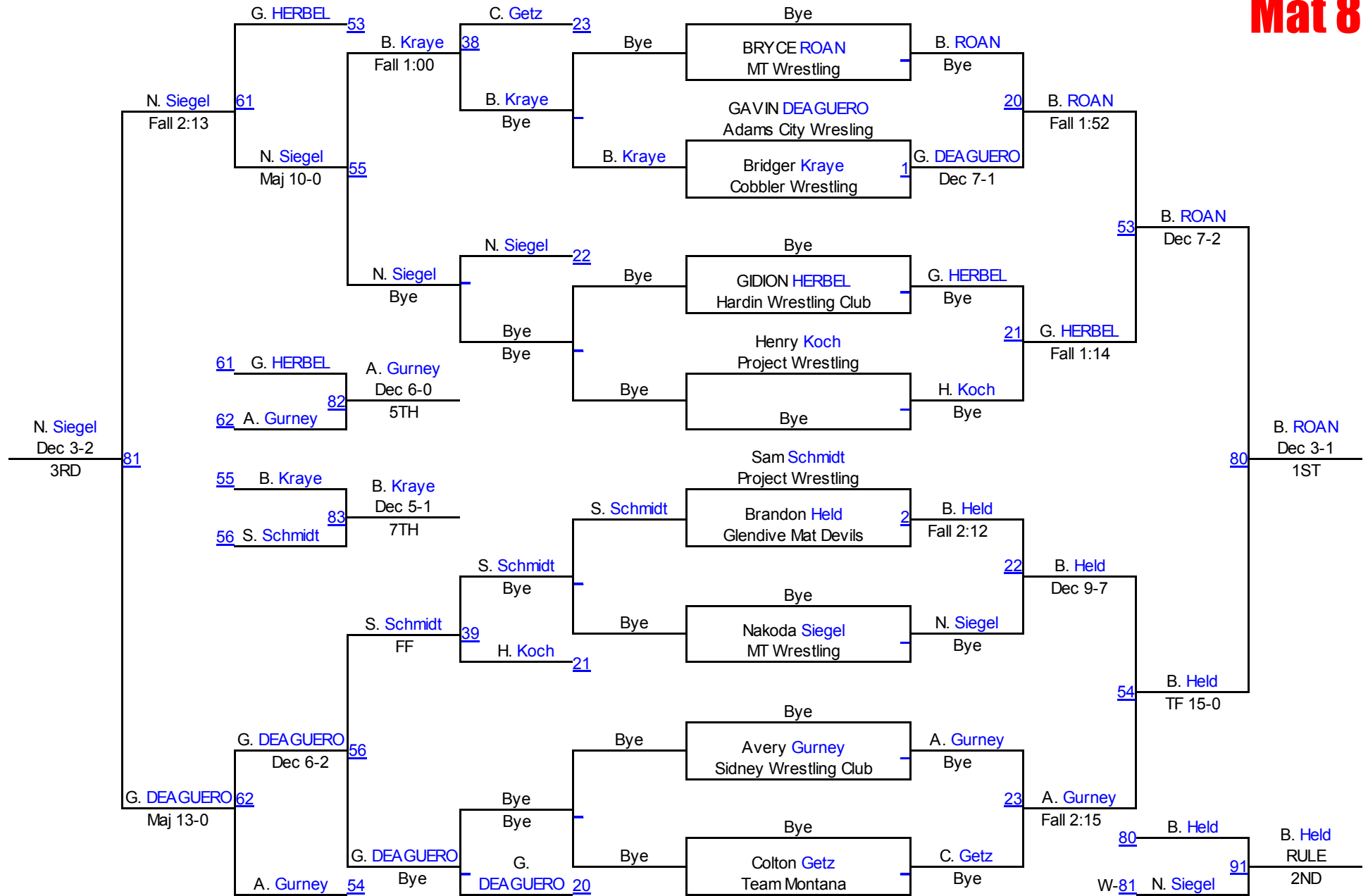

11th Black Hills & AAU Folk. Nationals

Schoolboy 125 Mat 8

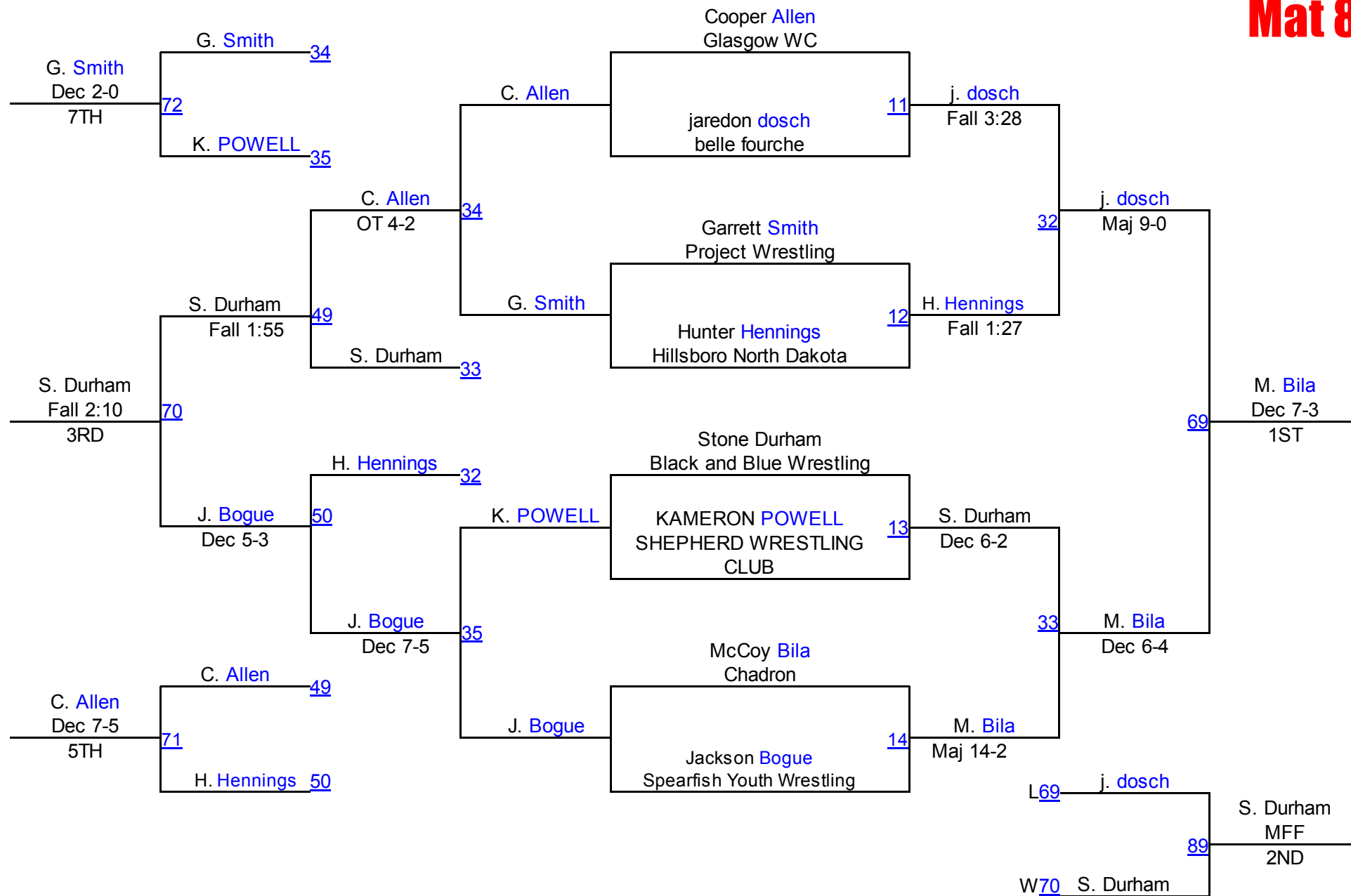

11th Black Hills & AAU Folk. Nationals

Schoolboy 130 Mat 8

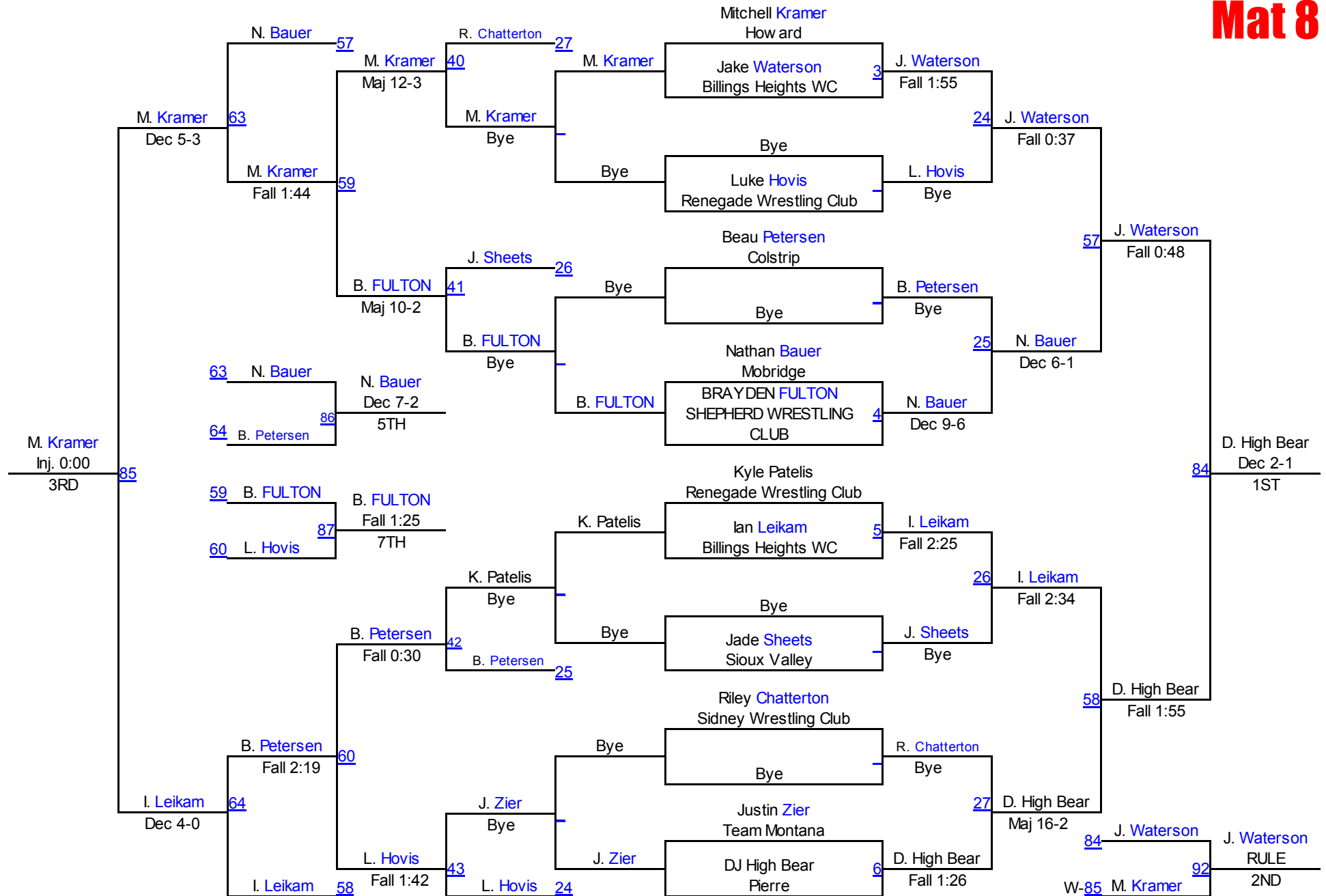

11th Black Hills & AAU Folk. Nationals

Schoolboy 140 Mat 9

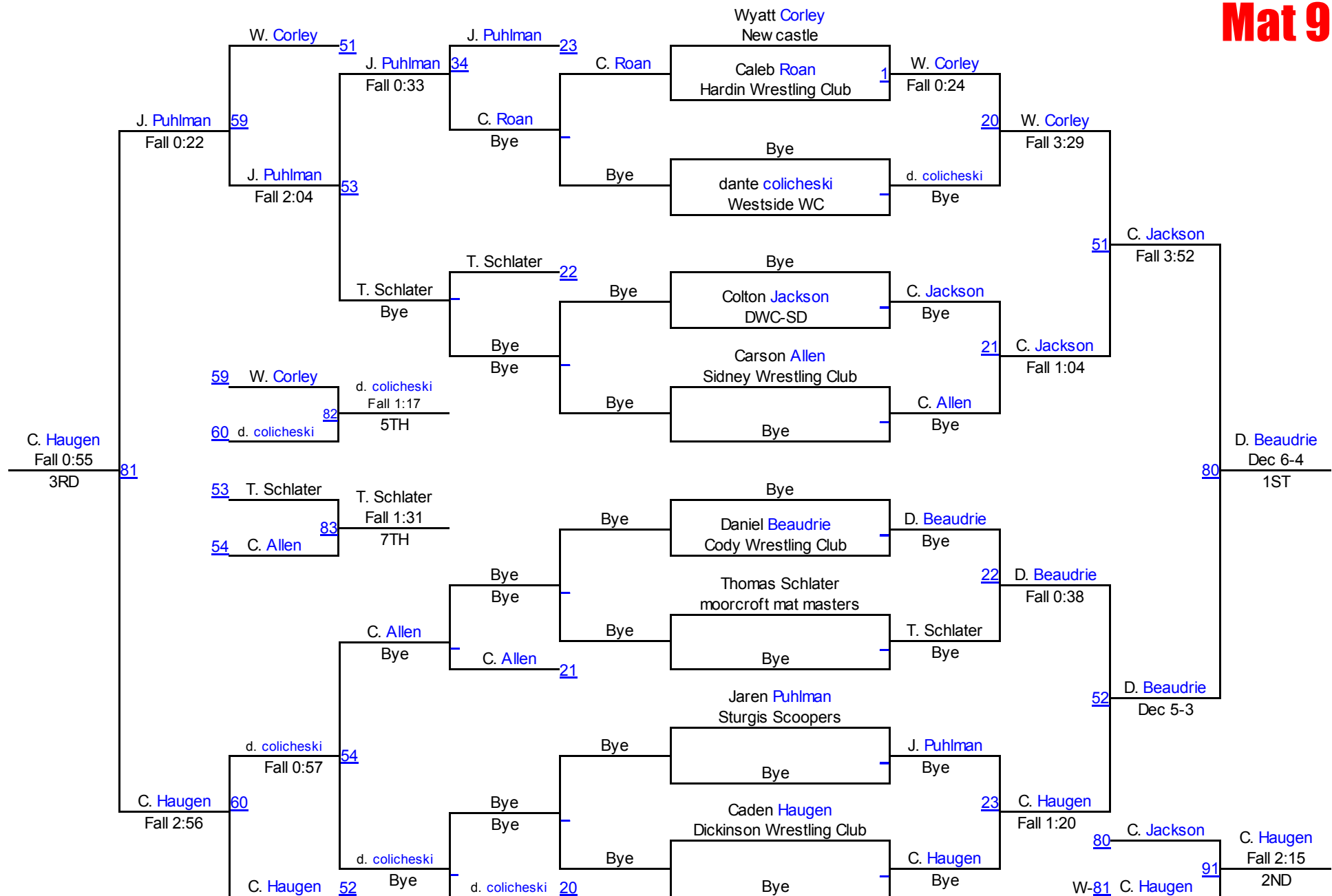

11th Black Hills & AAU Folk. Nationals

Schoolboy 150 Mat 8

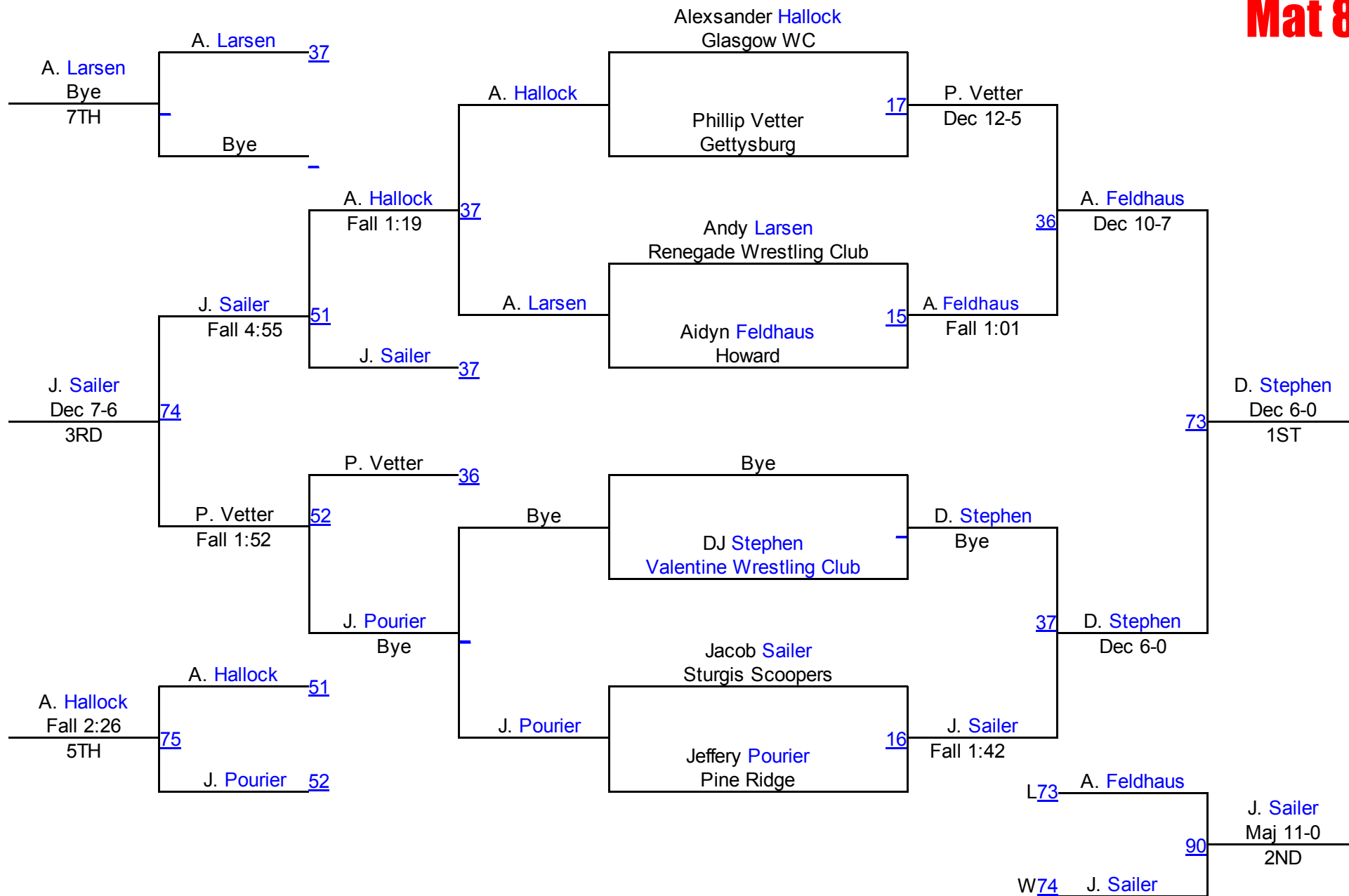

11th Black Hills & AAU Folk. Nationals

Schoolboy 160 Mat 9

Round 1

SONNY COCHRAN SHEPHERD WRESTL	SONNY COCHRAN SHEPHERD WRESTL
Jesse Murdock Hardin Wrestlin	TF 15-0
9	

Evan Kizer Howard	Wade Hahn Sainte Geneviev
Wade Hahn Sainte Geneviev	Dec 3-1
10	

Round 2

SONNY COCHRAN SHEPHERD WRESTL	Wade Hahn Sainte Geneviev
Wade Hahn Sainte Geneviev	Dec 4-1
36	

Evan Kizer Howard	Evan Kizer Howard
Jesse Murdock Hardin Wrestlin	Fall 0:42
37	

Round 3

SONNY COCHRAN SHEPHERD WRESTL	Evan Kizer Howard
Evan Kizer Howard	Maj 8-0
74	

Wade Hahn Sainte Geneviev	Wade Hahn Sainte Geneviev
Jesse Murdock Hardin Wrestlin	Fall 0:46
75	

W. Hahn (Sainte Genevieve Youth Wr)
1ST

E. Kizer (Howard)
2ND

S. COCHRAN (SHEPHERD WRESTLING CLUB)
3RD

J. Murdock (Hardin Wrestling Club)
4TH

11th Black Hills & AAU Folk. Nationals

Schoolboy 180 Mat 9

Round 1

Tucker Allison moorcroft mat m	Tucker Allison moorcroft mat m Dec 5-2
Kordell Miller Billings Wrestl	11

Jake Connelly Hillsboro North	Merlin Whitedirt Colstrip Fall 0:22
Merlin Whitedirt Colstrip	12

Round 2

Tucker Allison moorcroft mat m	Merlin Whitedirt Colstrip Fall 1:19
Merlin Whitedirt Colstrip	38

Jake Connelly Hillsboro North	Jake Connelly Hillsboro North Maj 12-1
Kordell Miller Billings Wrestl	39

Round 3

Tucker Allison moorcroft mat m	Tucker Allison moorcroft mat m Fall 4:21
Jake Connelly Hillsboro North	76

Merlin Whitedirt Colstrip	Merlin Whitedirt Colstrip Fall 0:28
Kordell Miller Billings Wrestl	77

M. Whitedirt (Colstrip)

1ST

T. Allison (moorcroft mat masters)

2ND

J. Connelly (Hillsboro North Dakota)

3RD

K. Miller (Billings Wrestling Club)

4TH

11th Black Hills & AAU Folk. Nationals

Schoolboy Hwt Mat 9

Round 1

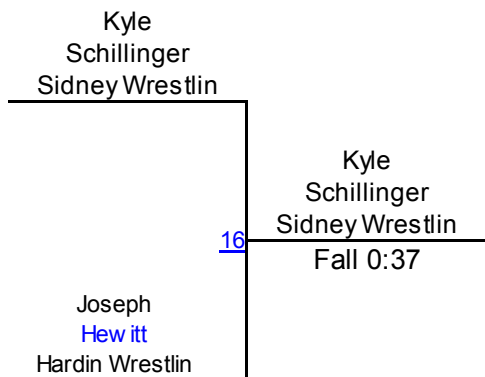

Round 2

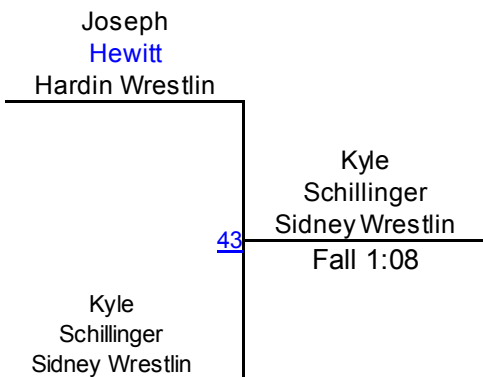

Round 3

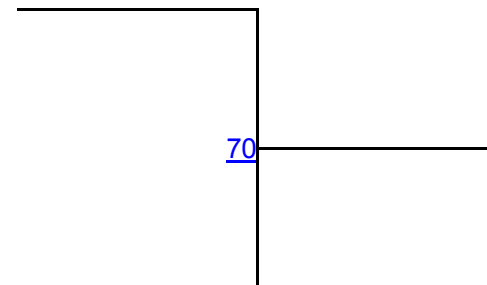

K. Schillinger (Sidney Wrestling Club)
1ST

J. Hewitt (Hardin Wrestling Club)
2ND

11th Black Hills & AAU Folk. Nationals

High School 98 Mat 9

Round 1

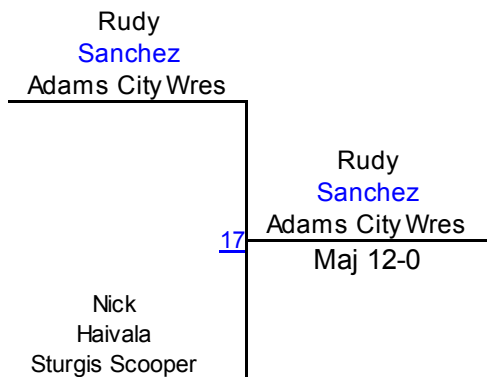

Round 2

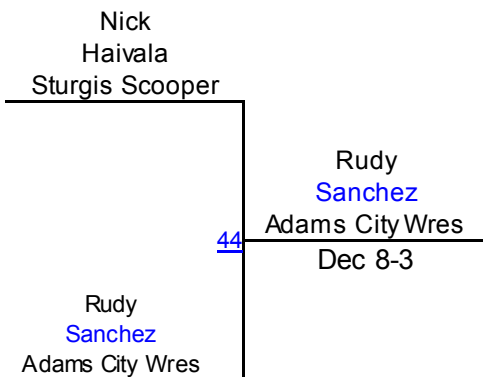

Round 3

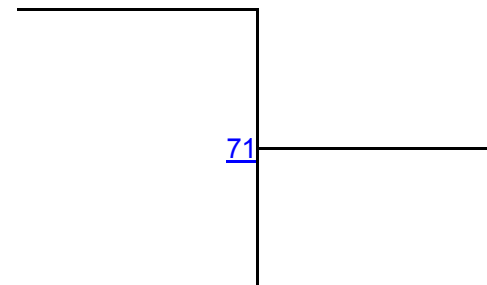

R. Sanchez (Adams City Wrestling)
1ST

N. Haivala (Sturgis Scoopers)
2ND

11th Black Hills & AAU Folk. Nationals

High School 106 Mat 9

Round 1

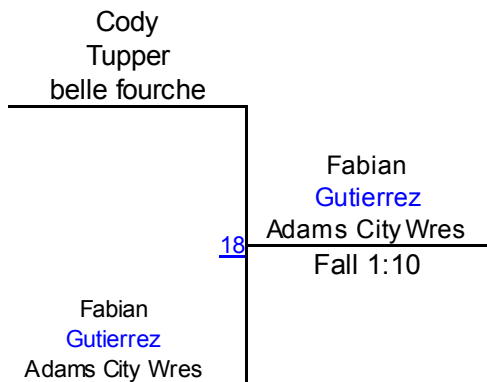

Round 2

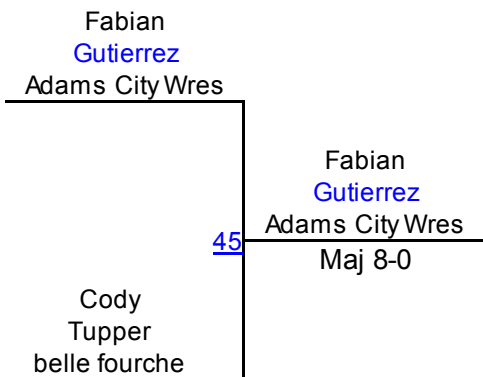

Round 3

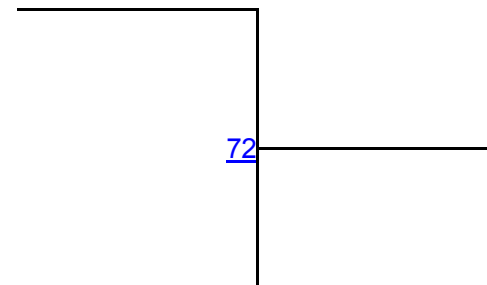

F. Gutierrez (Adams City Wrestling)

1ST

C. Tupper (belle fourche)

2ND

11th Black Hills & AAU Folk. Nationals

High School 113 Mat 9

Round 1

Cullen Olson Whitewood Wrest	Cullen Olson Whitewood Wrest
JAMES WHITMUS SHEPHERD WRESTL	Fall 1:05
13	

logan white Knob Noster Pan	Daniel Goings Chadron
Daniel Goings Chadron	Dec 8-6
14	

Round 2

Cullen Olson Whitewood Wrest	Cullen Olson Whitewood Wrest
Daniel Goings Chadron	Fall 3:55
40	

logan white Knob Noster Pan	logan white Knob Noster Pan
JAMES WHITMUS SHEPHERD WRESTL	Fall 1:45
41	

Round 3

Cullen Olson Whitewood Wrest	Cullen Olson Whitewood Wrest
logan white Knob Noster Pan	Dec 9-2
78	

Daniel Goings Chadron	Daniel Goings Chadron
JAMES WHITMUS SHEPHERD WRESTL	Fall 0:51
79	

C. Olson (Whitewood Wrestling Club)

1ST

D. Goings (Chadron)

2ND

I. white (Knob Noster Panthers)

3RD

J. WHITMUS (SHEPHERD WRESTLING CLUB)

4TH

11th Black Hills & AAU Folk. Nationals

High School 120 Mat 9

Round 1

Trey Fischbach Moorcroft Mat M	Trey Fischbach Moorcroft Mat M
Sterling Kraye 7	Fall 1:20
Cobbler Wrestli	

Tyler Waterson unattached	Tyler Waterson unattached
Chris Nash 8	Maj 16-5
Sturgis Scooper	

T. Waterson (unattached)
1ST

Round 2

Cale Schalesky Hettinger Huski	Cale Schalesky Hettinger Huski
Chris Nash 32	Dec 6-3
Sturgis Scooper	

Trey Fischbach Moorcroft Mat M	Tyler Waterson unattached
Tyler Waterson 33	Maj 16-4
unattached	

C. Schalesky (Hettinger Huskies)
2ND

Round 3

Cale Schalesky Hettinger Huski	Tyler Waterson unattached
Tyler Waterson 49	Dec 5-1
unattached	

Sterling Kraye Cobbler Wrestli	Chris Nash Sturgis Scooper
Chris Nash 50	Sturgis Scooper
Sturgis Scooper	Dec 3-0

T. Fischbach (Moorcroft Mat Mastersinge)
3RD

Round 4

Cale Schalesky Hettinger Huski	Cale Schalesky Hettinger Huski
Sterling Kraye 63	Dec 7-0
Cobbler Wrestli	

Trey Fischbach Moorcroft Mat M	Trey Fischbach Moorcroft Mat M
Chris Nash 64	Dec 6-2
Sturgis Scooper	

C. Nash (Sturgis Scoopers)
4TH

Round 5

Cale Schalesky Hettinger Huski	Cale Schalesky Hettinger Huski
Trey Fischbach 88	Dec 3-2
Moorcroft Mat M	

Sterling Kraye Cobbler Wrestli	Tyler Waterson unattached
Tyler Waterson 89	Maj 9-0
unattached	

S. Kraye (Cobbler Wrestling)
5TH

11th Black Hills & AAU Folk. Nationals

High School 126 Mat 9

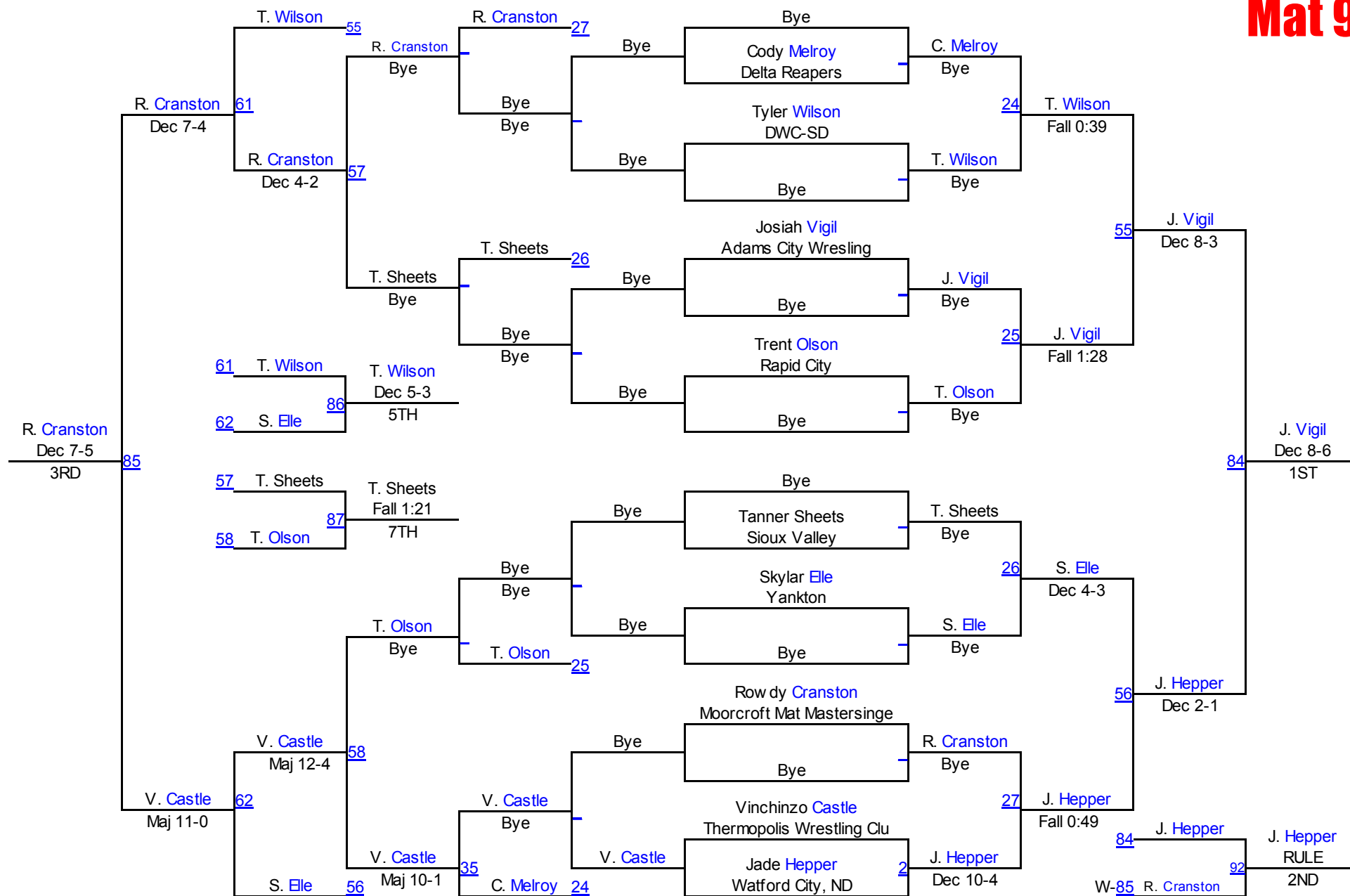

11th Black Hills & AAU Folk. Nationals

High School 132 Mat 9

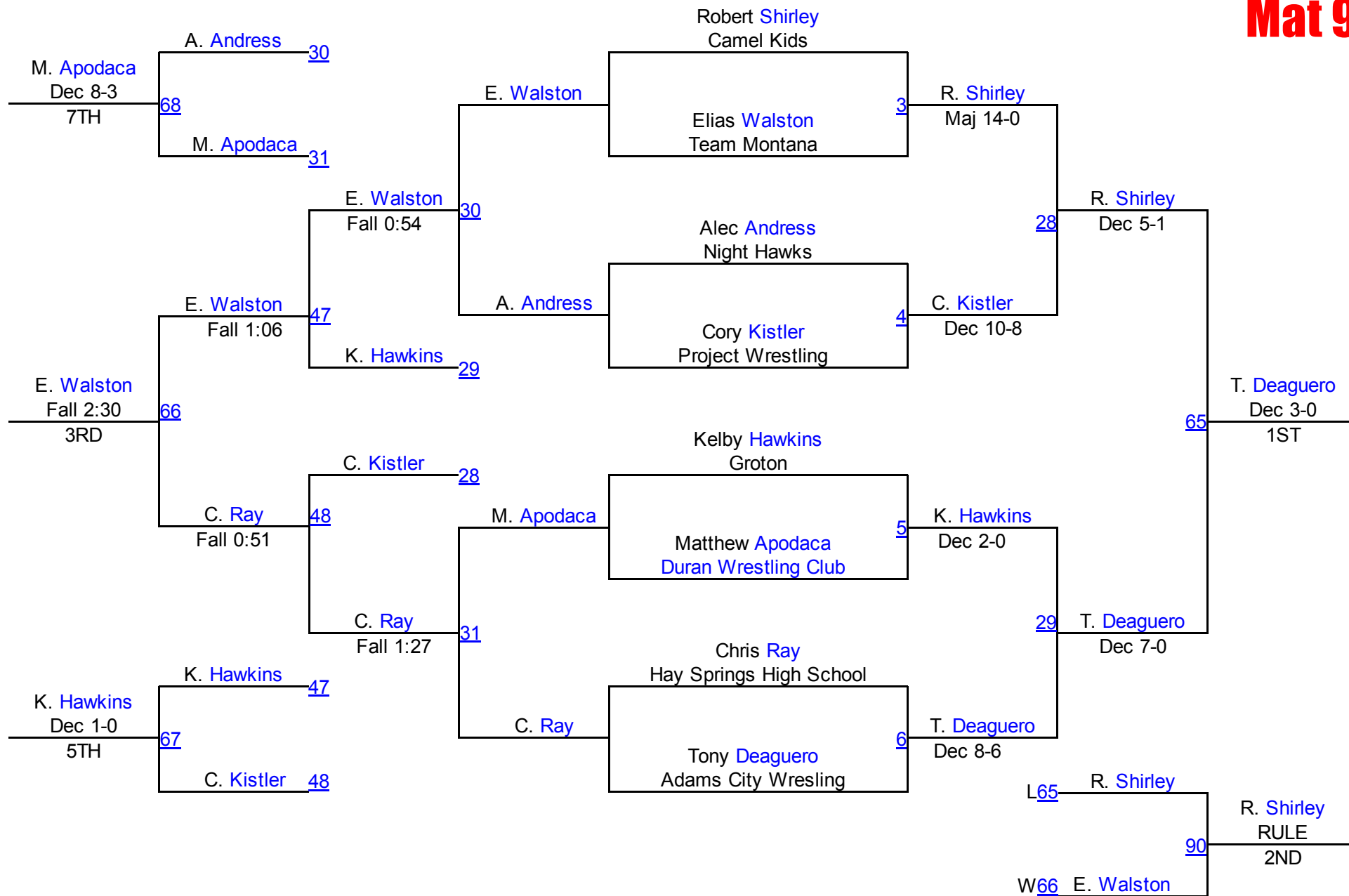

11th Black Hills & AAU Folk. Nationals

High School 138 Mat 10

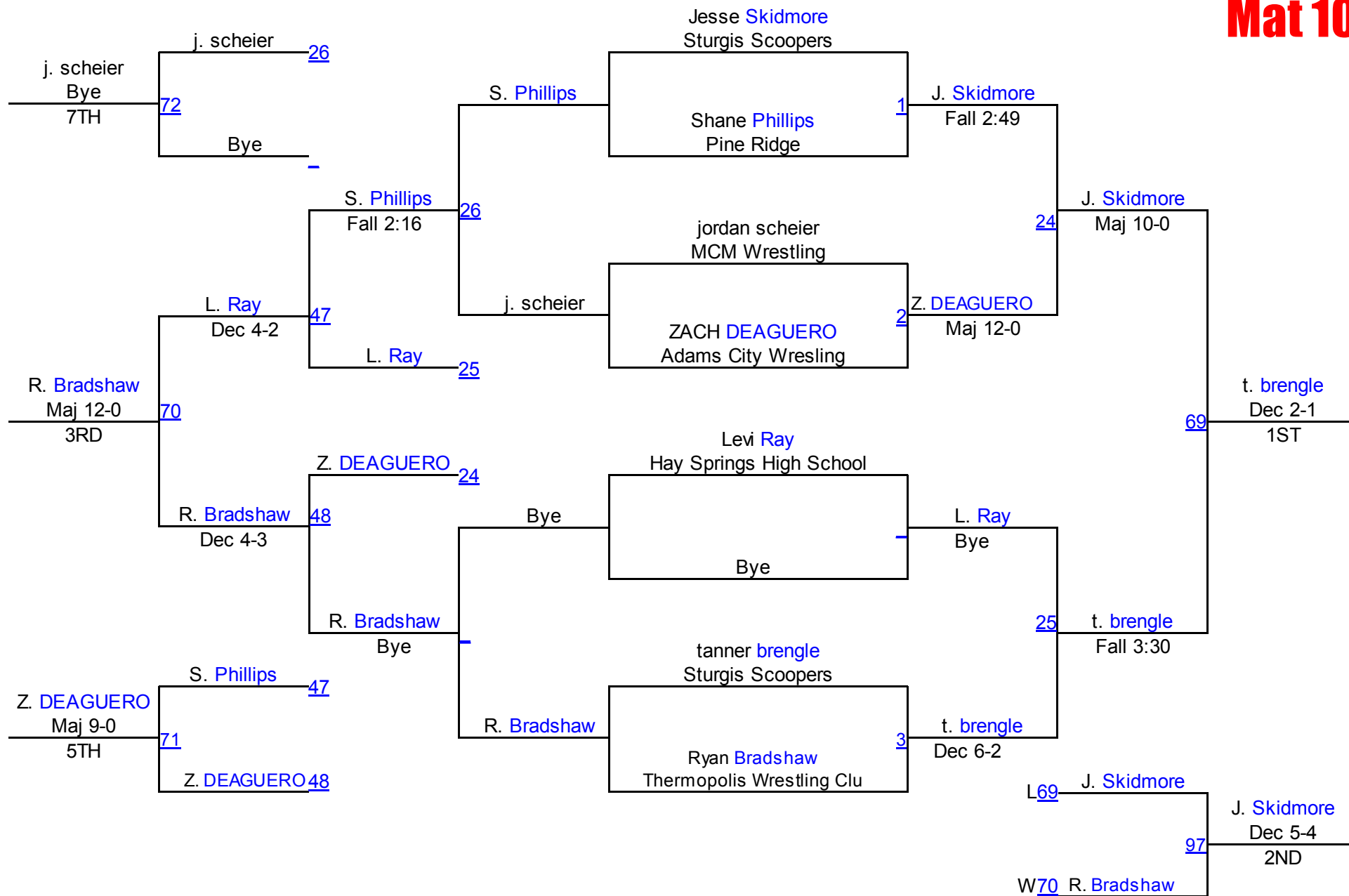

11th Black Hills & AAU Folk. Nationals

High School 145 Mat 10

Round 1

Round 2

Round 3

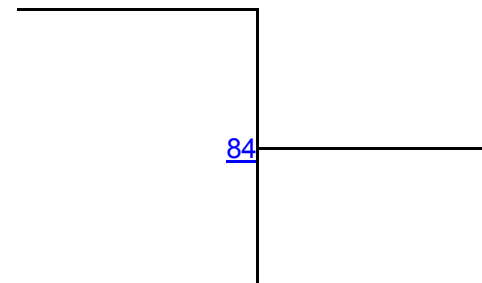
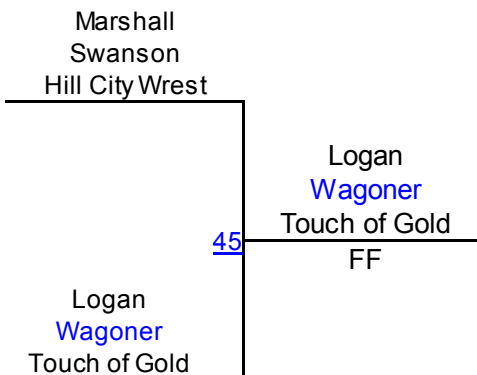
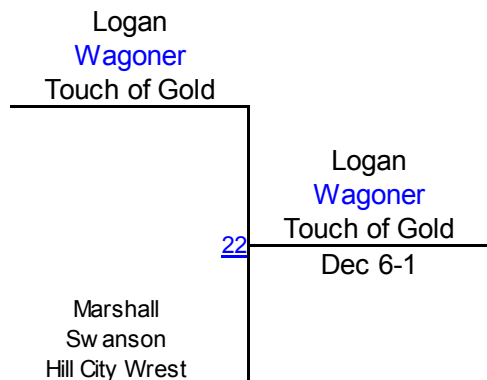

L. Wagoner (Touch of Gold)
1ST

M. Swanson (Hill City Wrestling)
2ND

11th Black Hills & AAU Folk. Nationals

High School 152 Mat 10

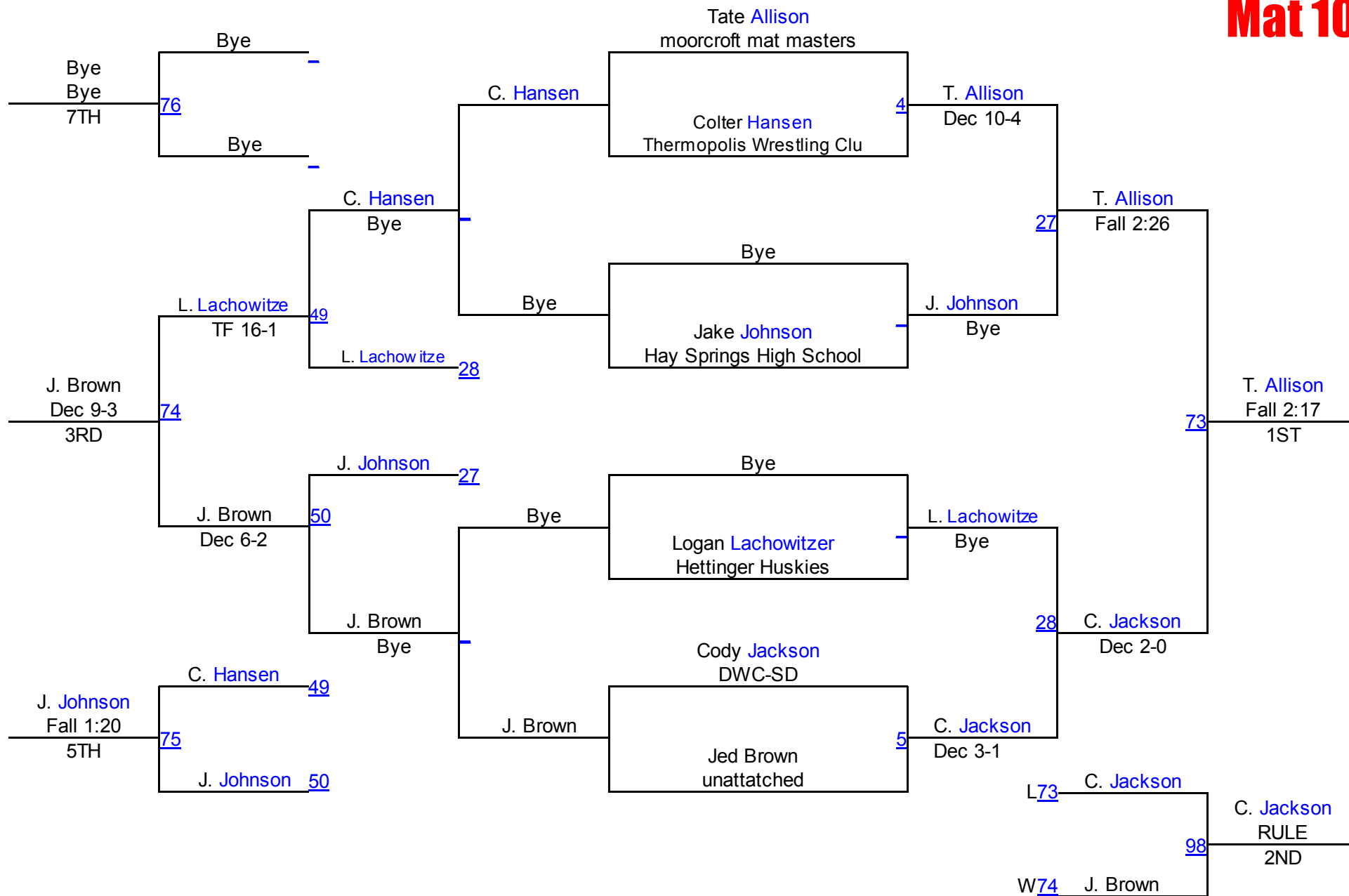

11th Black Hills & AAU Folk. Nationals

High School 160 Mat 10

Round 1

Gabino Ramirez Hardin Wrestlin	Robbie Darcy Yankton
Robbie Darcy <u>9</u> Yankton	Fall 4:21

Adonis Ruml Howard Tigers	Adonis Ruml Howard Tigers
Damian Hall <u>10</u> Spearfish Youth	TF 15-0

A. **Ruml** (Howard Tigers)
1ST

Round 2

Cody Stalder Fountain Fort C	Cody Stalder Fountain Fort C
Damian Hall <u>32</u> Spearfish Youth	Dec 9-2

Gabino Ramirez Hardin Wrestlin	Adonis Ruml Howard Tigers
Adonis Ruml <u>33</u> Howard Tigers	Fall 2:05

C. **Stalder** (Fountain Fort Carson)
2ND

Round 3

Cody Stalder Fountain Fort C	Adonis Ruml Howard Tigers
Adonis Ruml <u>53</u> Howard Tigers	Dec 1-0

Robbie Darcy Yankton	Robbie Darcy Yankton
Damian Hall <u>54</u> Spearfish Youth	Maj 11-2

R. **Darcy** (Yankton)
3RD

Round 4

Cody Stalder Fountain Fort C	Cody Stalder Fountain Fort C
Robbie Darcy <u>61</u> Yankton	Dec 6-4

Gabino Ramirez Hardin Wrestlin	Gabino Ramirez Hardin Wrestlin
Damian Hall <u>62</u> Spearfish Youth	TF 19-1

G. **Ramirez** (Hardin Wrestling Club)
4TH

Round 5

Cody Stalder Fountain Fort C	Cody Stalder Fountain Fort C
Gabino Ramirez <u>89</u> Hardin Wrestlin	Fall 1:15

Robbie Darcy Yankton	Adonis Ruml Howard Tigers
Adonis Ruml <u>90</u> Howard Tigers	Fall 3:40

D. Hall (Spearfish Youth Wrestling)
5TH

11th Black Hills & AAU Folk. Nationals

High School 170 Mat 10

Round 1

Stephon Dixon Pine Ridge	Tony Kaiser Glasgow WC
Tony Kaiser	11
Glasgow WC	

Zeb Demaray Dickinson Wrest	Zeb Demaray Dickinson Wrest
Alex Krieger	12
Elite Takedown	

B. Coleman (Valentine Wrestling)
1ST

Round 2

Braxton Coleman Valentine Wrest	Braxton Coleman Valentine Wrest
Alex Krieger	34
Elite Takedown	

Stephon Dixon Pine Ridge	Zeb Demaray Dickinson Wrest
Zeb Demaray	35
Dickinson Wrest	

Z. Demaray (Dickinson Wrestling Club)
2ND

Round 3

Braxton Coleman Valentine Wrest	Braxton Coleman Valentine Wrest
Zeb Demaray	55
Dickinson Wrest	

Tony Kaiser Glasgow WC	Tony Kaiser Glasgow WC
Alex Krieger	56
Elite Takedown	

T. Kaiser (Glasgow WC)
3RD

Round 4

Braxton Coleman Valentine Wrest	Braxton Coleman Valentine Wrest
Tony Kaiser	63
Glasgow WC	

Stephon Dixon Pine Ridge	Stephon Dixon Pine Ridge
Alex Krieger	64
Elite Takedown	

S. Dixon (Pine Ridge)
4TH

Round 5

Braxton Coleman Valentine Wrest	Braxton Coleman Valentine Wrest
Stephon Dixon	91
Pine Ridge	

Tony Kaiser Glasgow WC	Zeb Demaray Dickinson Wrest
Zeb Demaray	92
Dickinson Wrest	

A. Krieger (Elite Takedown Club)
5TH

11th Black Hills & AAU Folk. Nationals

High School 182 Mat 10

Round 1

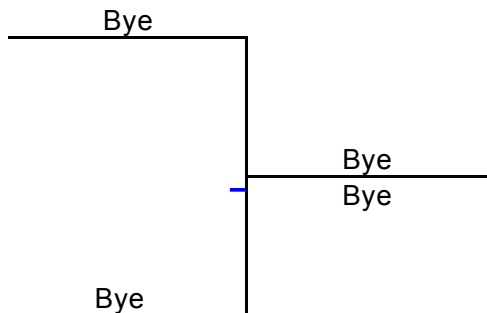

Round 2

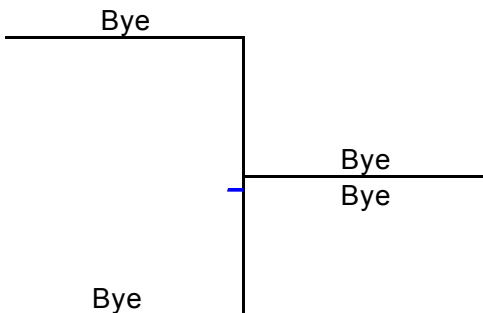

Round 3

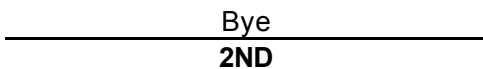
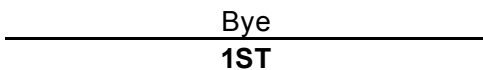
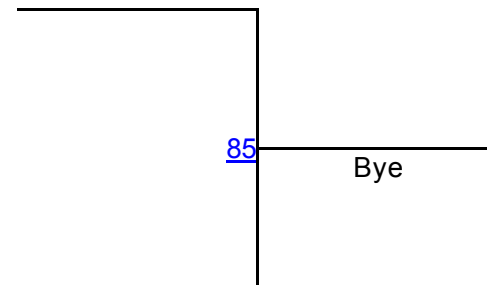

11th Black Hills & AAU Folk. Nationals

High School 195 Mat 10

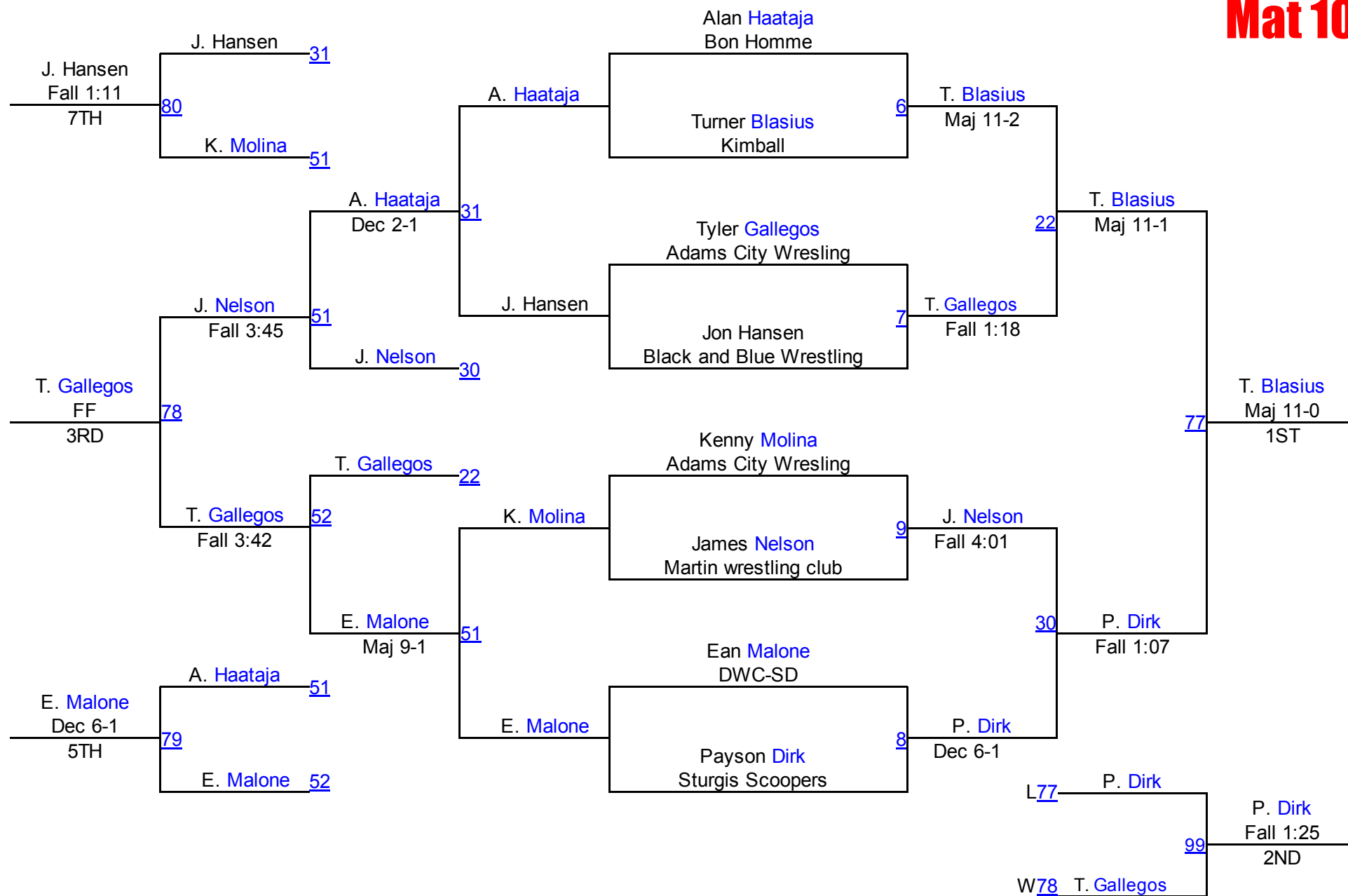

11th Black Hills & AAU Folk. Nationals

High School 220 Mat 10

Round 1

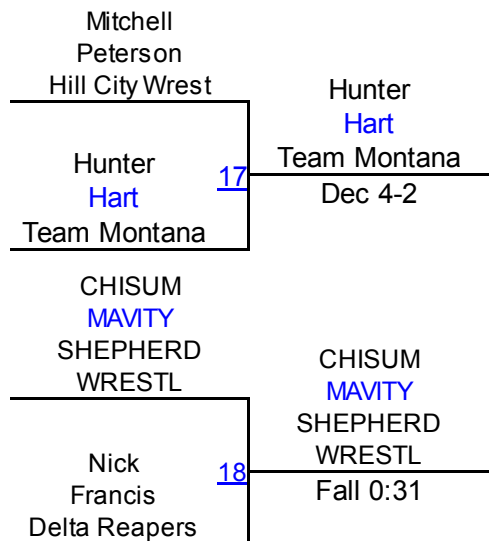

Round 2

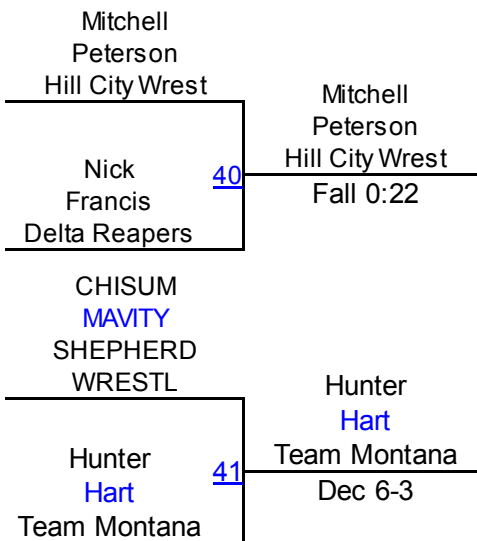

Round 3

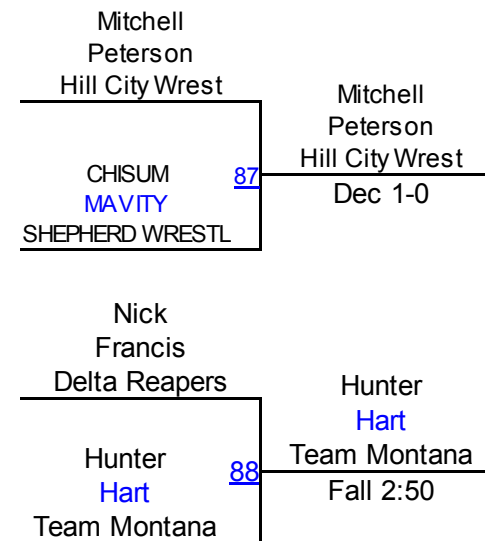

- H. Hart (Team Montana)
1ST
- M. Peterson (Hill City Wrestling)
2ND
- C. MAVITY (SHEPHERD WRESTLING CLUB)
3RD
- N. Francis (Delta Reapers)
4TH

11th Black Hills & AAU Folk. Nationals

High School 285 Mat 10

Round 1

Jess Trueblood Pine Ridge	Jess Trueblood Pine Ridge
Andrew Quick Bear Pine Ridge	Fall 3:45
13	

LUCAS DEKKER SHEPHERD WRESTL	LUCAS DEKKER SHEPHERD WRESTL
Parker Sutton Spearfish Youth	Maj 9-0
14	

J. Trueblood (Pine Ridge)
1ST

Round 2

Trevor Gress Harding county	Trevor Gress Harding county
Parker Sutton Spearfish Youth	Fall 2:07
36	

Jess Trueblood Pine Ridge	Jess Trueblood Pine Ridge
LUCAS DEKKER SHEPHERD WRESTL	Fall 1:04
37	

L. DEKKER (SHEPHERD WRESTLING CLUB)
2ND

Round 3

Trevor Gress Harding county	LUCAS DEKKER SHEPHERD WRESTL
LUCAS DEKKER SHEPHERD WRESTL	Fall 0:31
57	

Andrew Quick Bear Pine Ridge	Andrew Quick Bear Pine Ridge
Parker Sutton Spearfish Youth	FF
58	

T. Gress (Harding county)
3RD

Round 4

Trevor Gress Harding county	Trevor Gress Harding county
Andrew Quick Bear Pine Ridge	Fall 0:49
65	

Jess Trueblood Pine Ridge	Jess Trueblood Pine Ridge
Parker Sutton Spearfish Youth	FF
66	

A. Quick Bear (Pine Ridge)
4TH

Round 5

Trevor Gress Harding county	Jess Trueblood Pine Ridge
Jess Trueblood Pine Ridge	Dec 11-7
93	

Andrew Quick Bear Pine Ridge	LUCAS DEKKER SHEPHERD WRESTL
LUCAS DEKKER SHEPHERD WRESTL	Dec 2-1
94	

P. Sutton (Spearfish Youth Wrestling)
5TH

11th Black Hills & AAU Folk. Nationals

Senior 165/174 Mat 10

Round 1

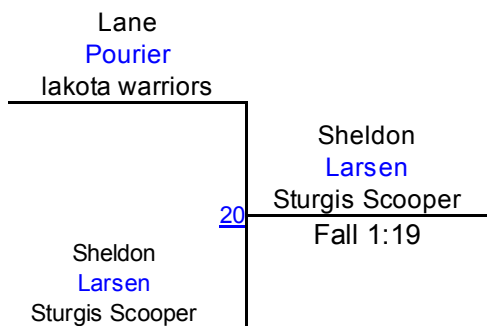

Round 2

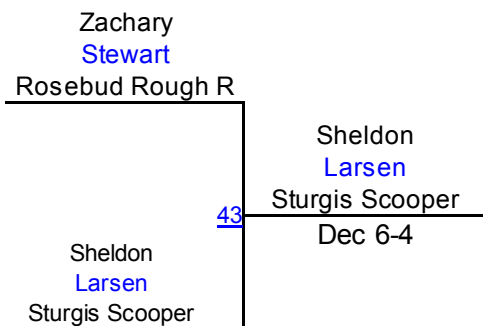

Round 3

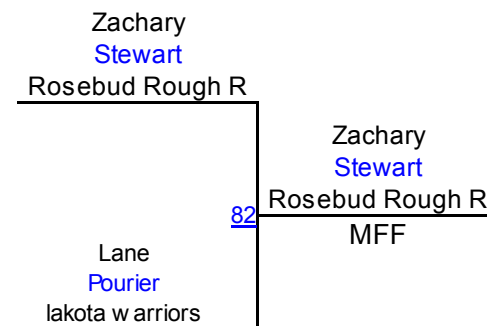

S. Larsen (Sturgis Scoopers)
1ST

Z. Stewart (Rosebud Rough Riders)
2ND

L. Pourier (lakota warriors)
3RD

11th Black Hills & AAU Folk. Nationals

Senior 185 Mat 10

Round 1

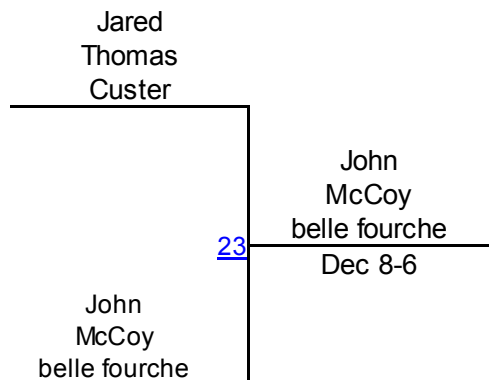

Round 2

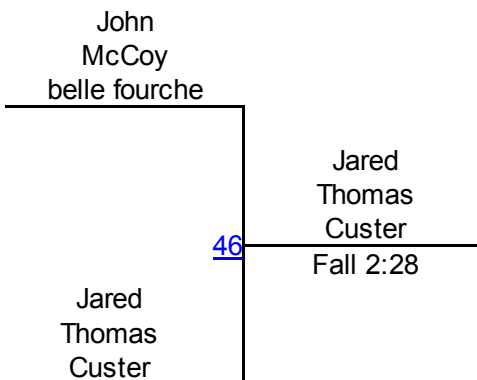

Round 3

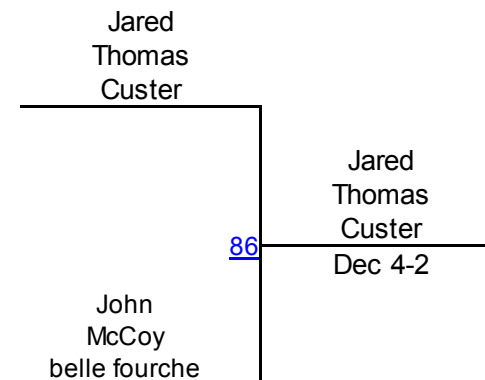

J. Thomas (Custer)
1ST

J. McCoy (belle fourche)
2ND

11th Black Hills & AAU Folk. Nationals

Senior 197 Mat 10

Round 1

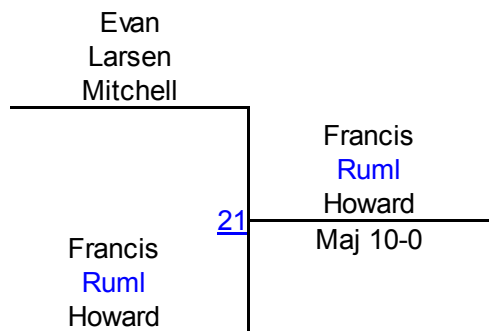

Round 2

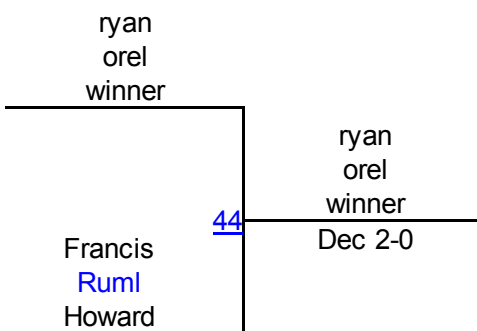

Round 3

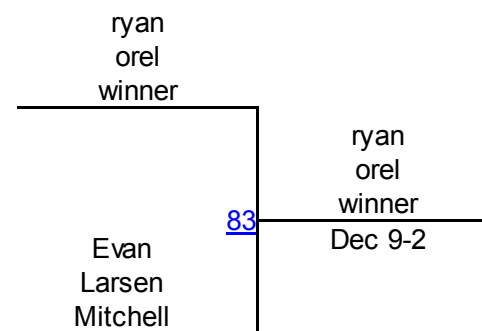

r. orel (winner)

1ST

F. Ruml (Howard)

2ND

E. Larsen (Mitchell)

3RD

11th Black Hills & AAU Folk. Nationals

Senior Hwt Mat 10

Round 1

Tanner Allison Moorcroft Mat M	Trent Gross Harding county
Trent Gross	Harding county
15	Fall 0:53

Jason Pechous Bon Homme	Philip Thomas belle fourche
Philip Thomas	belle fourche
16	Fall 0:25

T. Gross (Harding county)
1ST

Round 2

Julian Hernandez lakota warriors	Philip Thomas belle fourche
Philip Thomas	belle fourche
38	Fall 2:50

Tanner Allison Moorcroft Mat M	Jason Pechous Bon Homme
Jason Pechous	Bon Homme
39	Fall 2:27

P. Thomas (belle fourche)
2ND

Round 3

Julian Hernandez lakota warriors	Jason Pechous Bon Homme
Jason Pechous	Bon Homme
59	Maj 9-0

Trent Gross Harding county	Trent Gross Harding county
Philip Thomas	belle fourche
60	Fall 4:04

J. Pechous (Bon Homme)
3RD

Round 4

Julian Hernandez lakota warriors	Trent Gross Harding county
Trent Gross	Harding county
67	Fall 0:32

Tanner Allison Moorcroft Mat M	Philip Thomas belle fourche
Philip Thomas	belle fourche
68	Fall 0:56

T. Allison (Moorcroft Mat Mastersing)
4TH

Round 5

Julian Hernandez lakota warriors	Tanner Allison Moorcroft Mat M
Tanner Allison	Moorcroft Mat M
95	Fall 0:24

Trent Gross Harding county	Trent Gross Harding county
Jason Pechous	Bon Homme
96	Fall 0:45

J. Hernandez (lakota warriors)
5TH

11th Black Hills & AAU Folk. Nationals

Masters 149/165 Mat 9

Round 1

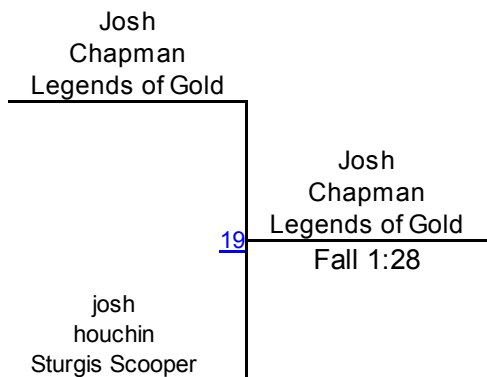

Round 2

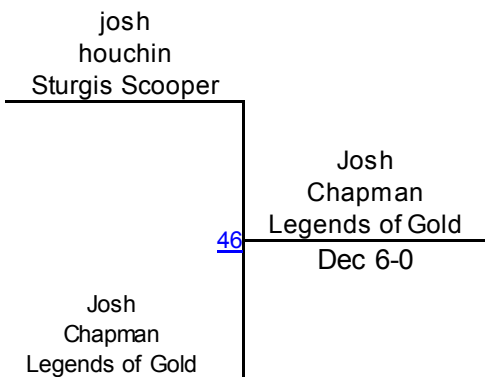

Round 3

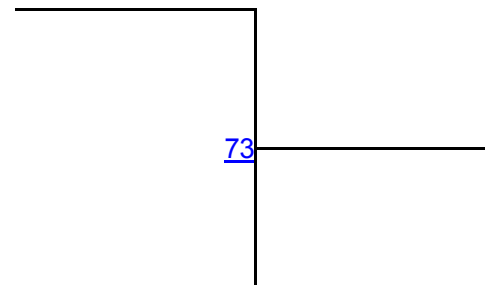

J. Chapman (Legends of Gold)
1ST

j. houchin (Sturgis Scoopers)
2ND

11th Black Hills & AAU Folk. Nationals

Masters 174/185 Mat 9

Round 1

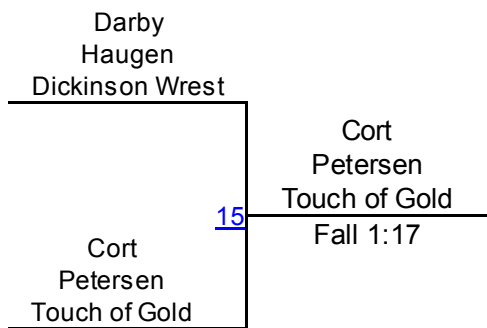

Round 2

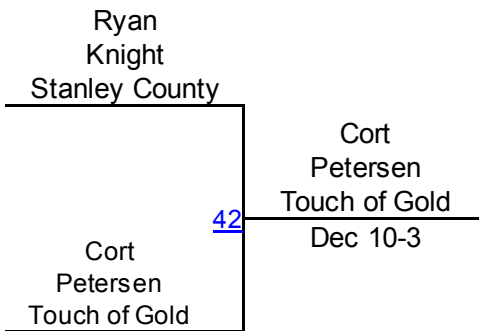

Round 3

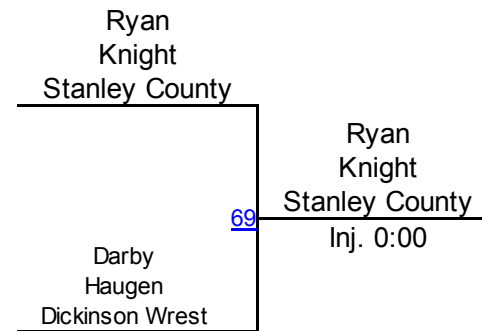

C. Petersen (Touch of Gold)
1ST

R. Knight (Stanley County)
2ND

D. Haugen (Dickinson Wrestling Club)
3RD