

2010 Spring Youth Nationals Results

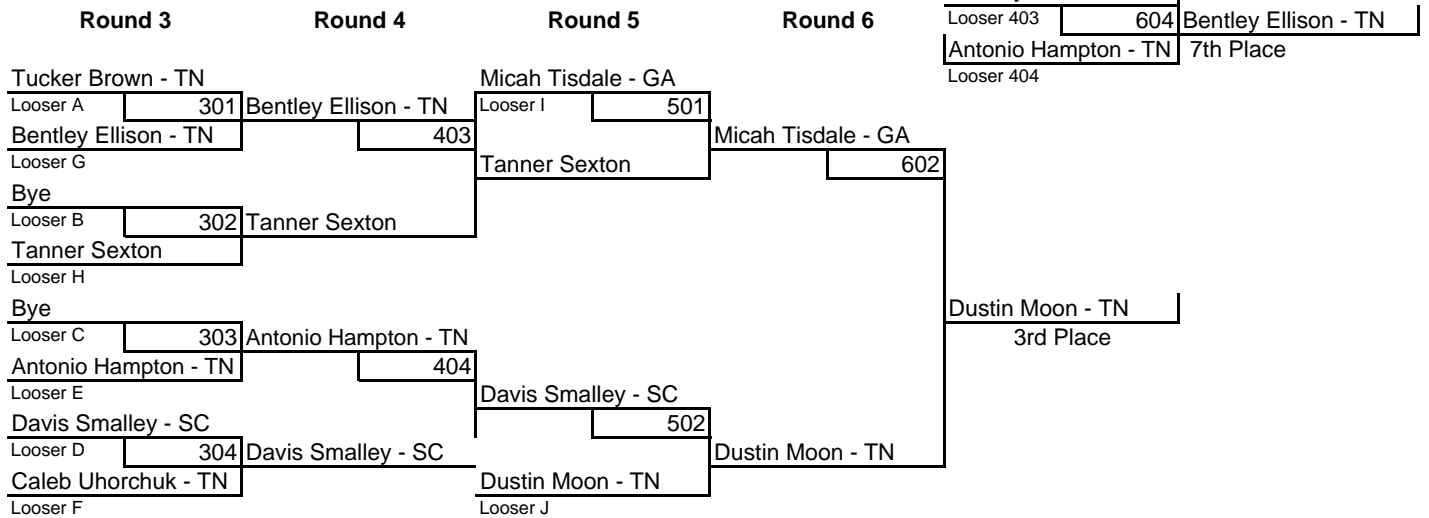
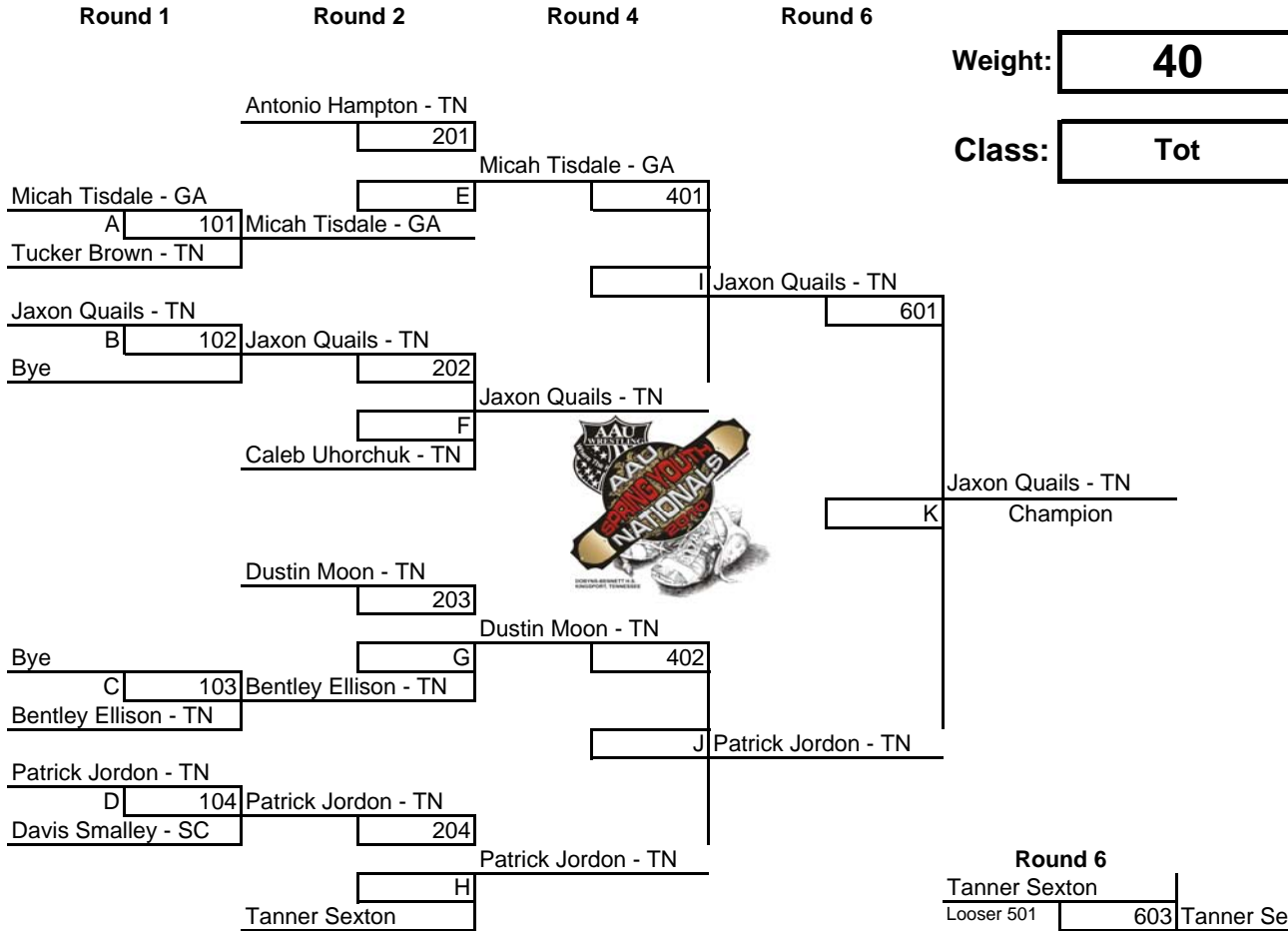

Round 6		
Tanner Sexton		
Looser 501	603	Tanner Sexton
Davis Smalley - SC		5th Place
Looser 502		
Bentley Ellison - TN		
Looser 403	604	Bentley Ellison - TN
Antonio Hampton - TN		7th Place
Looser 404		

Class:

Tot

Weight:

45

Round 4

Round 3

Round 2

Round 1

Round 2

Round 4

Taron Gosnel - TN

Bye

105

Taron Gosnel - TN

207

Bye

205

Jackson Boggess - TN

305

Jackson Boggess - TN

106

Adam Masterson - MO

Jackson Boggess - TN

Adam Masterson - MO

A

Taron Gosnel - TN

405

Jackson Boggess - TN

406

Nicholas Mercante - TN

Looser B



C

Taron Gosnel - TN
Champion

Eli Etherton - TN

Xander Myers - TN

208

Xander Myers - TN

Eli Etherton - TN

206

Xander Myers - TN

306

Bye

108

Nicholas Mercante - TN

B

Eli Etherton - TN

Adam Masterson - MO

3rd Place

Adam Masterson - MO

Adam Masterson - MO

Looser A

Nicholas Mercante - TN

Looser 305

407

Xander Myers - TN

Xander Myers - TN

5th Place

Looser 306

Looser 207

408

Looser 208

7th Place

Round 1

1 Bryson Montano - TN
 109
 Anthony Mannella - GA

2 Anthony Mannella - GA

3 Will Hoff - VA
 110
 Will Hoff - VA

4 Bye

Round 2

1 Bryson Montano - TN
 209
 Will Hoff - VA

3 Will Hoff - VA

2 Anthony Mannella - GA
 210
 Anthony Mannella - GA

5 Bye

Round 3

1 Bryson Montano - TN
 307
 Bryson Montano - TN

4 Bye

2 Anthony Mannella - GA
 308
 Anthony Mannella - GA

6 Will Hoff - VA

	Name	Wins	Losses
1	Bryson Montano - TN		
2	Anthony Mannella - GA		
3	Will Hoff - VA		
4			



- 1 Anthony Mannella - GA
- 2 Will Hoff - VA
- 3 Bryson Montano - TN
- 4

Class Tot

Weight 50

Round 1

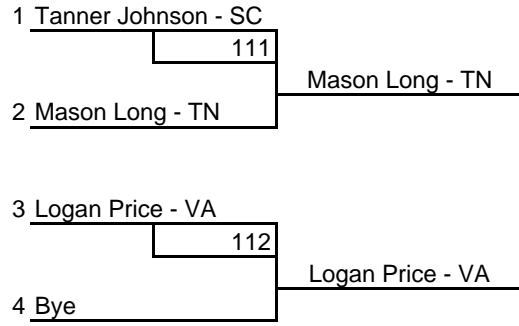

Round 2

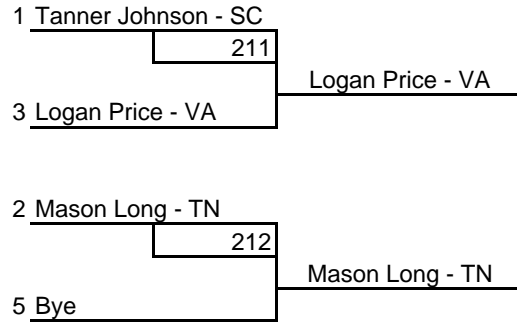

Round 3

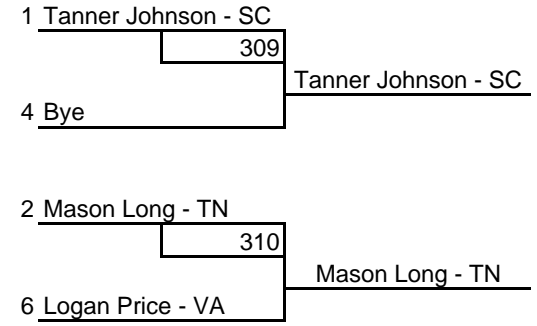

	Name	Wins	Losses
1	Tanner Johnson - SC		
2	Mason Long - TN		
3	Logan Price - VA		
4			

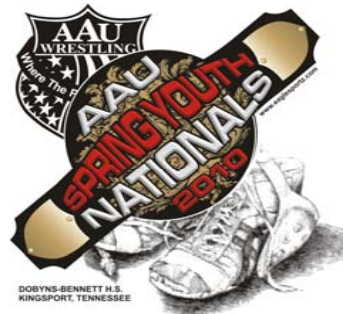

- 1 Mason Long - TN
- 2 Logan Price - VA
- 3 Tanner Johnson - SC
- 4 _____

Class Tot

Weight 55

Round 1

1 Colin Berta - TN
 113
 Colin Berta - TN
 2 Lance Williams - TN

Round 2

1 Colin Berta - TN
 213
 Lance Williams - TN
 2 Lance Williams - TN

**Round 3
 If Needed**

1 Colin Berta - TN
 311
 Colin Berta - TN
 2 Lance Williams - TN

Best 2 out of 3

	Name	Wins	Losses
1	Colin Berta - TN		
2	Lance Williams - TN		
3			
4			

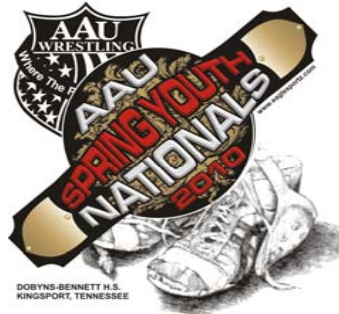

1 Colin Berta - TN
 2 Lance Williams - TN
 3 _____
 4 _____

Class Tot

Weight HWT

Round 1

1 Brandon Tackett - FL
 115
Brandon Tackett - FL

2 Gavin Butler - GA
 116
Joseph Nielsen - TN

Round 2

1 Brandon Tackett - FL
 215
Brandon Tackett - FL

3 Joseph Nielsen - TN
 216
Gavin Butler - GA

Round 3

1 Brandon Tackett - FL
 313
Brandon Tackett - FL

4 Quincy Cornish - NC
 314
Joseph Nielsen - TN

	Name	Wins	Losses
1	Brandon Tackett - FL		
2	Gavin Butler - GA		
3	Joseph Nielsen - TN		
4	Quincy Cornish - NC		

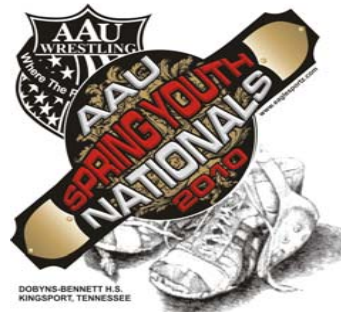

- 1 Brandon Tackett - FL
- 2 Joseph Nielsen - TN
- 3 Gavin Butler - GA
- 4 Quincy Cornish - NC

Class Bantam

Weight 40

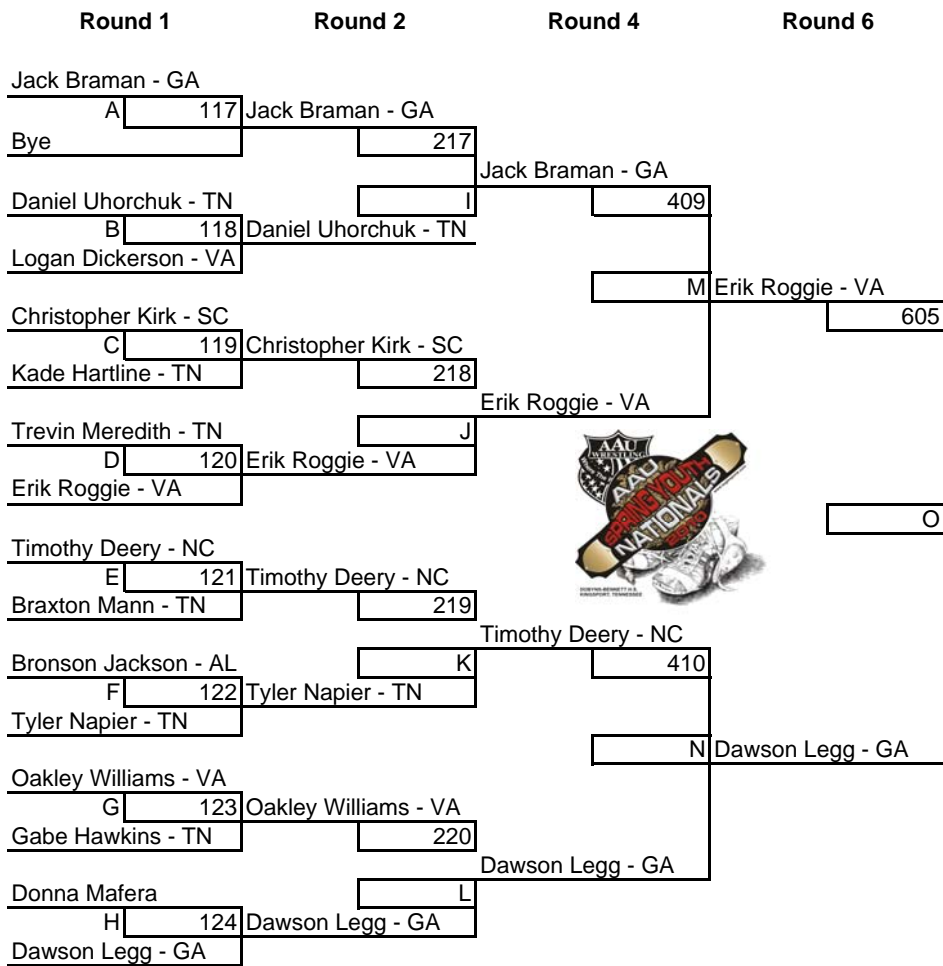

Weight: **45**

Class: **Bantam**

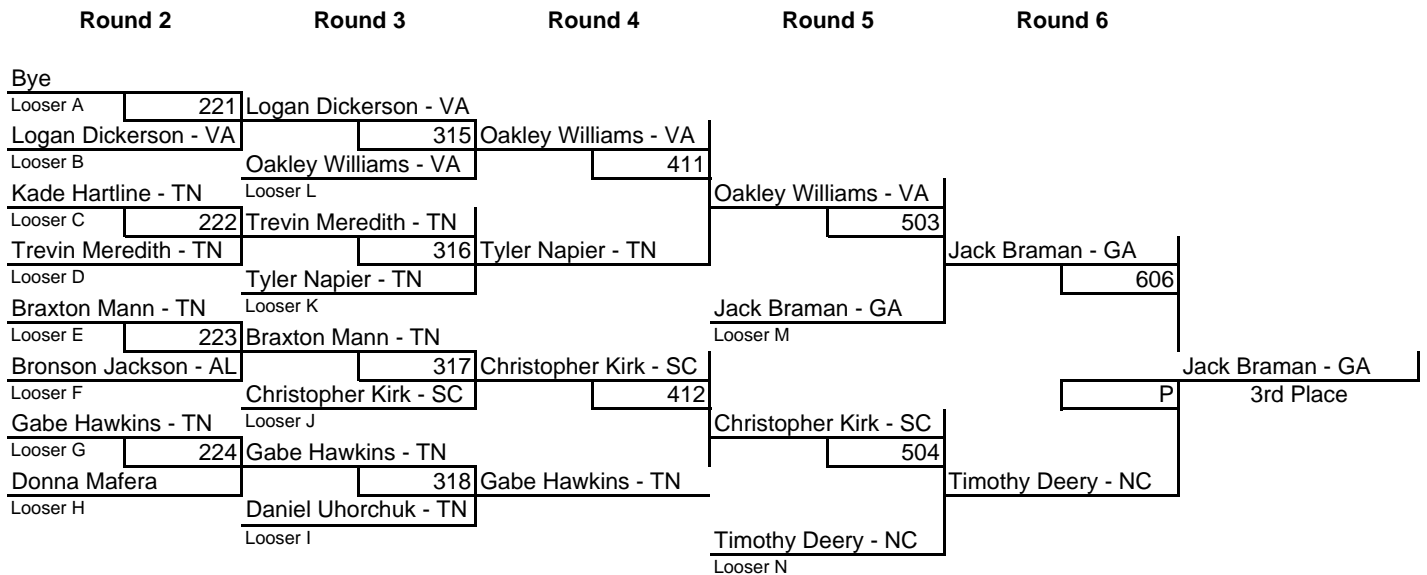
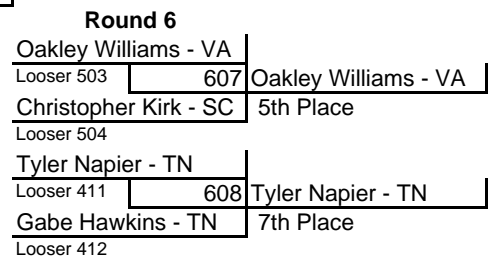

Round 1

Round 2

Round 4

Round 6

Weight: **50**

Class: **Bantam**

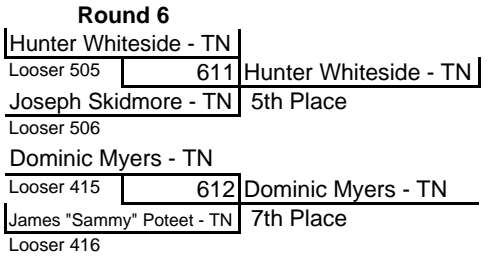
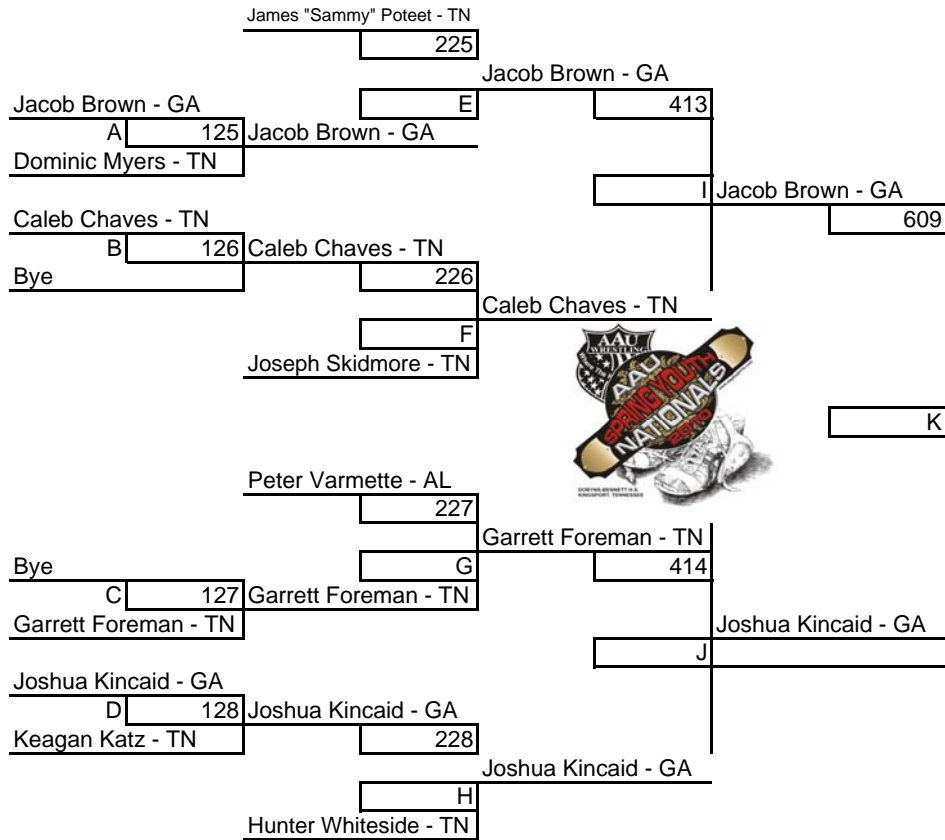

Round 3

Round 4

Round 5

Round 6

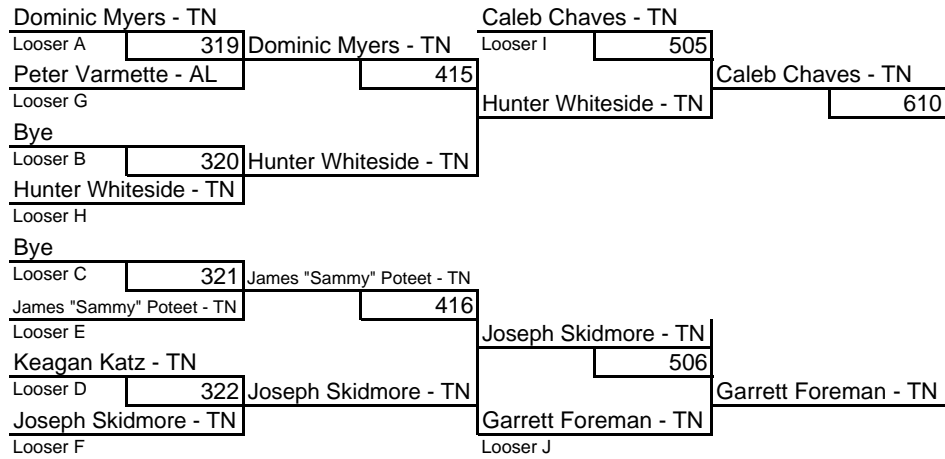

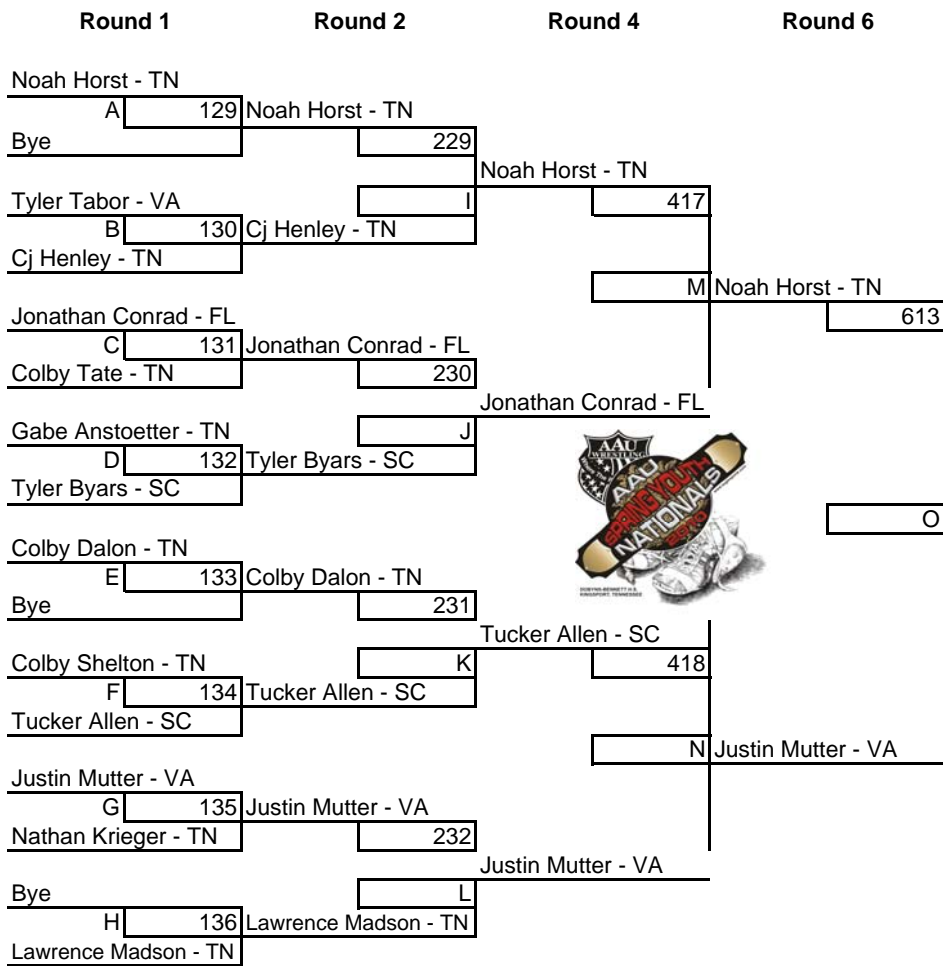

Weight: **55**

Class: **Bantam**

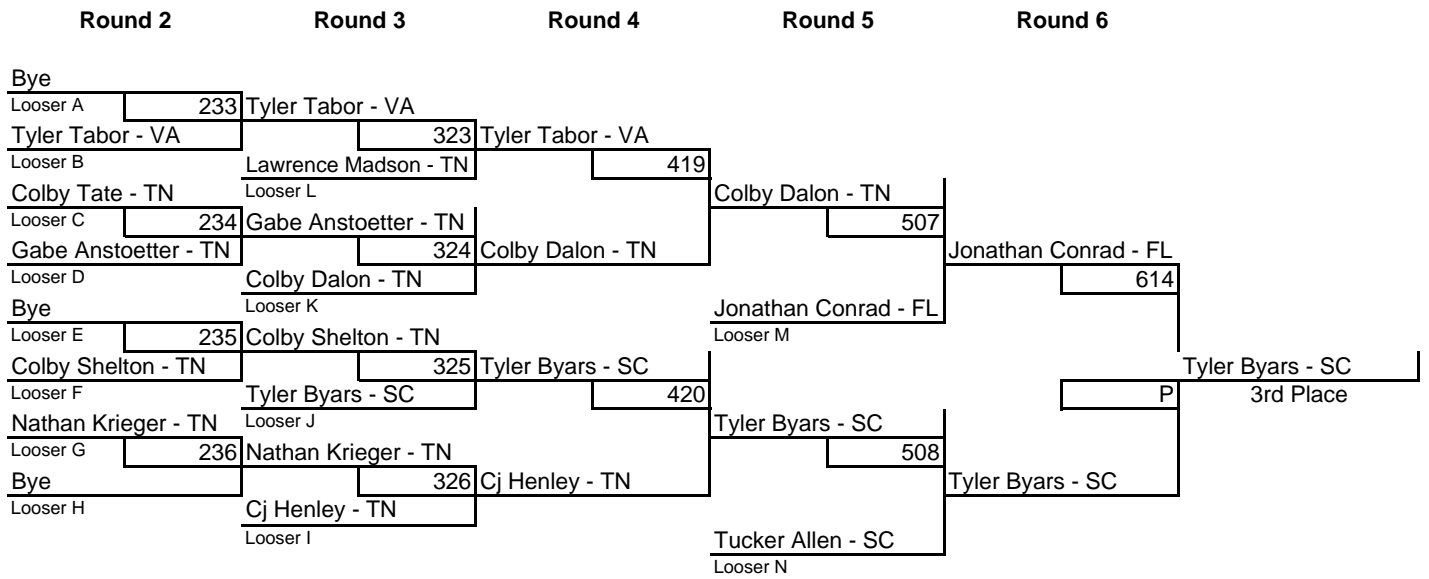
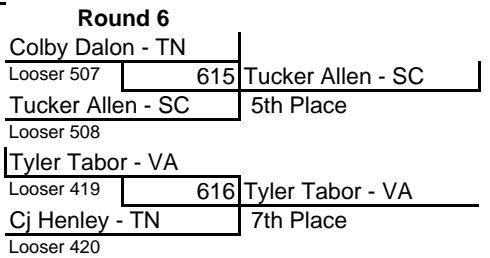

Class:

Bantam

Weight:

60

Round 4

Round 3

Round 2

Round 1

Round 2

Round 4

Jacob Roberts - TN

Jacob Roberts - TN

James Dubois

James Dubois

Benjamin Maholtz - SC

Jeremiah Neff - TN

Jeremiah Neff - TN

Benjamin Maholtz - SC

Jeremiah Neff - TN

Jeremiah Neff - TN

Benjamin Maholtz - SC

Lucas Isolani - TN

William Varmette - AL

William Varmette - AL

Lucas Isolani - TN

Jeremiah Neff - TN

Lucas Isolani - TN

Jordan Hibbert - TN

3rd Place

William Varmette - AL

Nathaniel Pulliam - MO

Nathaniel Pulliam - MO

Jordan Hibbert - TN

James Dubois

Jordan Hibbert - TN

James Dubois

Lucas Isolani - TN

Jacob Roberts - TN

Looser A

Looser 327

Lucas Isolani - TN

Looser 239

Jacob Roberts

William Varmette - AL

5th Place

Nathaniel Pulliam - MO

7th Place

Looser 328

Looser 240



Bantam

60

Jeremiah Neff - TN

3rd Place

Jeremiah Neff - TN

James Dubois

Lucas Isolani - TN

Looser B

William Varmette - AL

James Dubois

Looser A

Jacob Roberts - TN

Jeremiah Neff - TN

William Varmette - AL

Nathaniel Pulliam - MO

Lucas Isolani - TN

Looser 327

William Varmette - AL

Looser 328

James Dubois

Benjamin Maholtz - SC

Lucas Isolani - TN

Jordan Hibbert - TN

Lucas Isolani - TN

5th Place

Looser 328

James Dubois

Benjamin Maholtz - SC

Benjamin Maholtz - SC

Lucas Isolani - TN

Jordan Hibbert - TN

Lucas Isolani - TN

5th Place

Looser 328

Benjamin Maholtz - SC

A

Benjamin Maholtz - SC

B

Jordan Hibbert - TN

Jacob Roberts - TN

Looser 239

Nathaniel Pulliam - MO

Looser 240

Benjamin Maholtz - SC

Benjamin Maholtz - SC

Benjamin Maholtz

Champion

Jordan Hibbert - TN

Jacob Roberts - TN

Looser 239

Nathaniel Pulliam - MO

Looser 240

60

Benjamin Maholtz

Champion

Jacob Roberts

7th Place

Round 4

Round 3

Round 2

Round 1

Round 2

Round 4

Jacob Roberts - TN

Jacob Roberts - TN

James Dubois

James Dubois

Benjamin Maholtz - SC

Jeremiah Neff - TN

Jeremiah Neff - TN

Benjamin Maholtz - SC

Jeremiah Neff - TN

Jeremiah Neff - TN

Benjamin Maholtz - SC

Lucas Isolani - TN

William Varmette - AL

William Varmette - AL

Lucas Isolani - TN

Jeremiah Neff - TN

Lucas Isolani - TN

Jordan Hibbert - TN

3rd Place

William Varmette - AL

Nathaniel Pulliam - MO

Nathaniel Pulliam - MO

Jordan Hibbert - TN

James Dubois

Jordan Hibbert - TN

James Dubois

Lucas Isolani - TN

Jacob Roberts - TN

Looser A

Looser 327

Lucas Isolani - TN

Looser 239

Jacob Roberts

William Varmette - AL

5th Place

Nathaniel Pulliam - MO

7th Place

Looser 328

Looser 240



Bantam

60

Jeremiah Neff - TN

3rd Place

Jeremiah Neff - TN

James Dubois

Lucas Isolani - TN

Looser B

William Varmette - AL

James Dubois

Looser A

Jacob Roberts - TN

Jeremiah Neff - TN

William Varmette - AL

Nathaniel Pulliam - MO

Lucas Isolani - TN

Looser 327

William Varmette - AL

Looser 328

James Dubois

Benjamin Maholtz - SC

Lucas Isolani - TN

Jordan Hibbert - TN

Lucas Isolani - TN

5th Place

Looser 328

James Dubois

Benjamin Maholtz - SC

Benjamin Maholtz - SC

Lucas Isolani - TN

Jordan Hibbert - TN

Lucas Isolani - TN

5th Place

Looser 328

Benjamin Maholtz - SC

A

Benjamin Maholtz - SC

B

Jordan Hibbert - TN

Jacob Roberts - TN

Looser 239

Nathaniel Pulliam - MO

Looser 240

Benjamin Maholtz - SC

Benjamin Maholtz - SC

Benjamin Maholtz

Champion

Jordan Hibbert - TN

Jacob Roberts - TN

Looser 239

Nathaniel Pulliam - MO

Looser 240

60

Benjamin Maholtz

Champion

Jacob Roberts

7th Place

Round 1

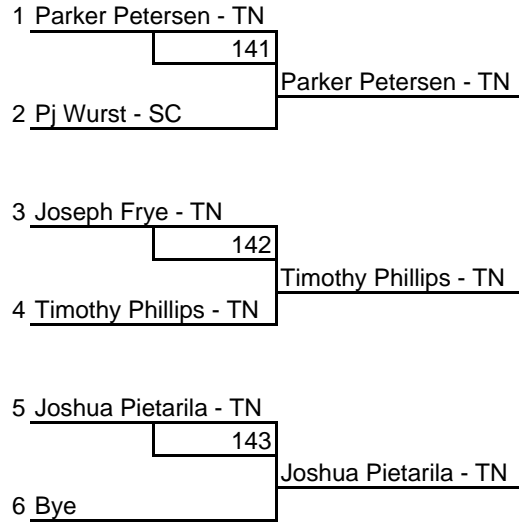

Round 2

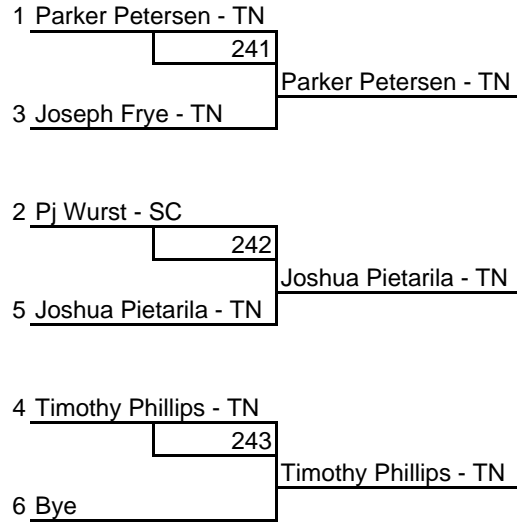

Round 3

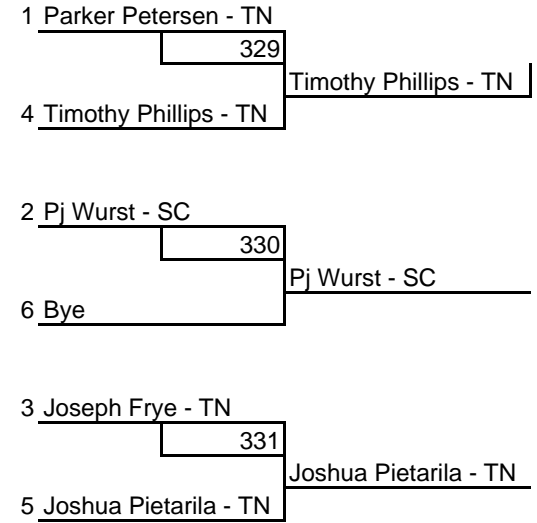

PL	Name	Wins	Losses
3	Parker Petersen - TN	3	2
4	Pj Wurst - SC	2	3
5	Joseph Frye - TN	1	4
2	Timothy Phillips - TN	4	1
1	Joshua Pietarila - TN	5	0

Class [Bantam]

Weight [65]

Round 4

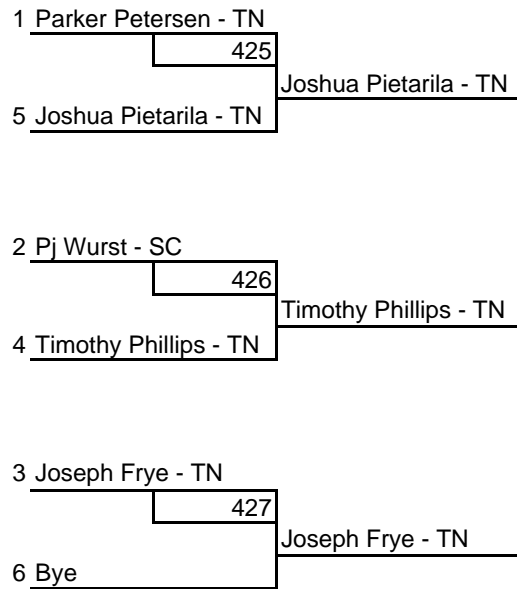

Round 5

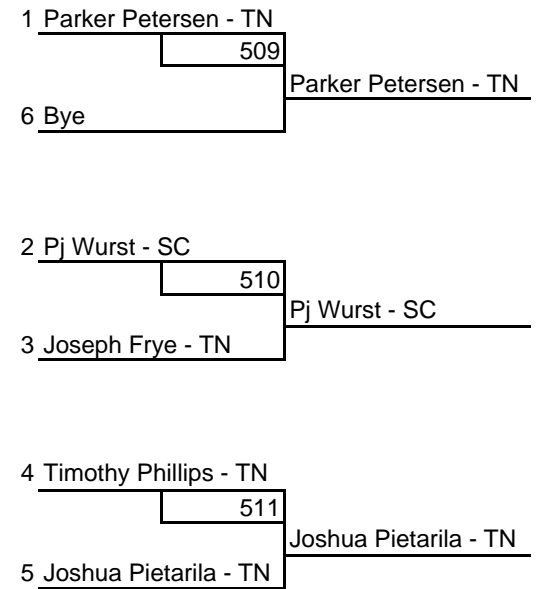

Round 1

1 James Neff - TN
 _____ 144
 _____ Connor Bailey - TN

2 Connor Bailey - TN

3 *X* Tommy Chang - VA *X*
 _____ 145
 _____ Dylan Pensa - TN

4 Dylan Pensa - TN

Round 2

1 James Neff - TN
 _____ 244
 _____ James Neff - TN

3 *X* Tommy Chang - VA *X*

2 Connor Bailey - TN
 _____ 245
 _____ Connor Bailey - TN

5 Dylan Pensa - TN

Round 3

1 James Neff - TN
 _____ 332
 _____ James Neff - TN

4 Dylan Pensa - TN

2 Connor Bailey - TN
 _____ 333
 _____ Connor Bailey - TN

6 *X* Tommy Chang - VA *X*

1st at 75
 X CANNOT PLACE AT 70

	Name	Wins	Losses
2	James Neff - TN	2	1
1	Connor Bailey - TN	3	0
	X Tommy Chang - VA *X*		
3	Dylan Pensa - TN	1	2

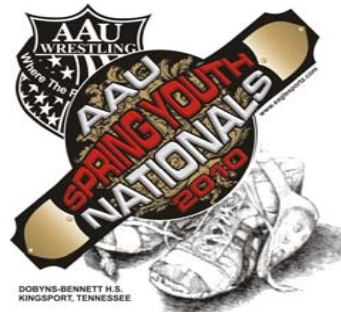

- 1 Connor Bailey - TN
- 2 James Neff - TN
- 3 Dylan Pensa - TN
- 4 _____

Class Bantam

Weight 70

Round 1

1 Coale Gamble - TN
 _____ 146 _____
 Coale Gamble - TN
 2 Bye _____

3 Bye _____
 _____ 147 _____
 4 Bye _____

Round 2

1 Coale Gamble - TN
 _____ 246 _____
 Coale Gamble - TN
 3 Bye _____

2 Bye _____
 _____ 247 _____
 5 Bye _____

Round 3

1 Coale Gamble - TN
 _____ 334 _____
 Coale Gamble - TN
 4 Bye _____

2 Bye _____
 _____ 335 _____
 6 Bye _____

	Name	Wins	Losses
1	Coale Gamble - TN	3	0
2			
3			
4			

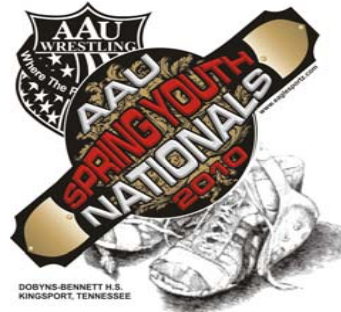

1 _____
 Coale Gamble - TN
 2 _____
 3 _____
 4 _____

Class Bantam

Weight HWT

Round 1

Round 2

Round 4

Round 6

Weight: **50**

Class: **Midget**

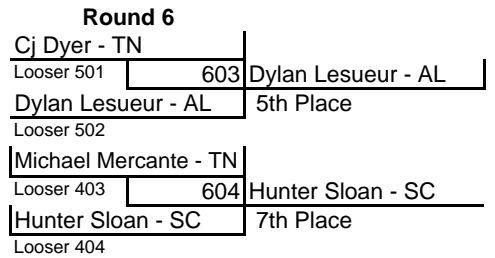
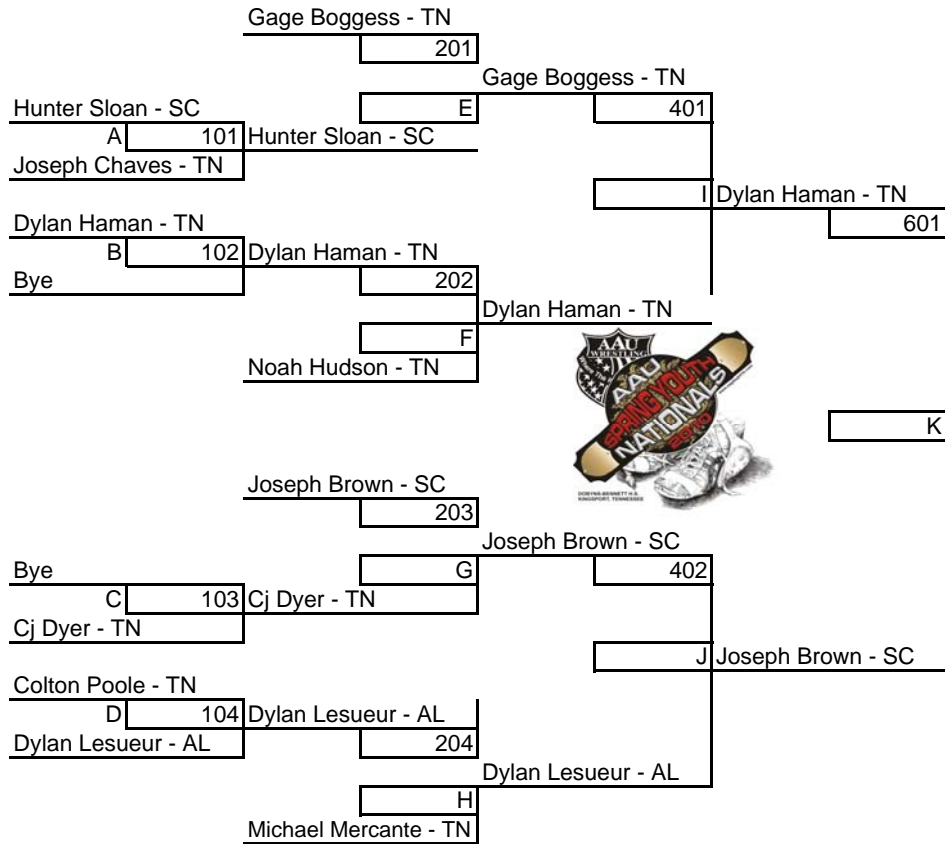

Round 3

Round 4

Round 5

Round 6

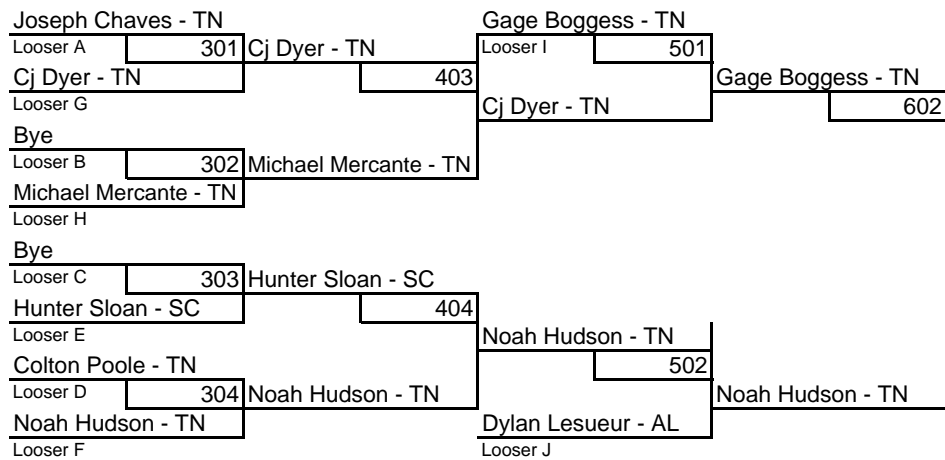

Gage Boggess - TN
3rd Place

Round 1

Round 2

Round 4

Round 6

Weight: **55**

Class: **Midget**

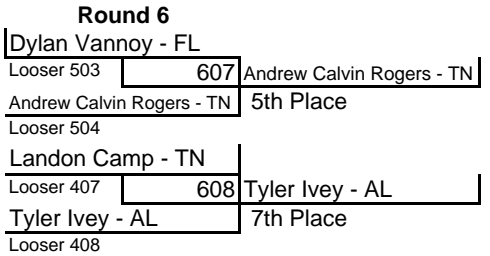
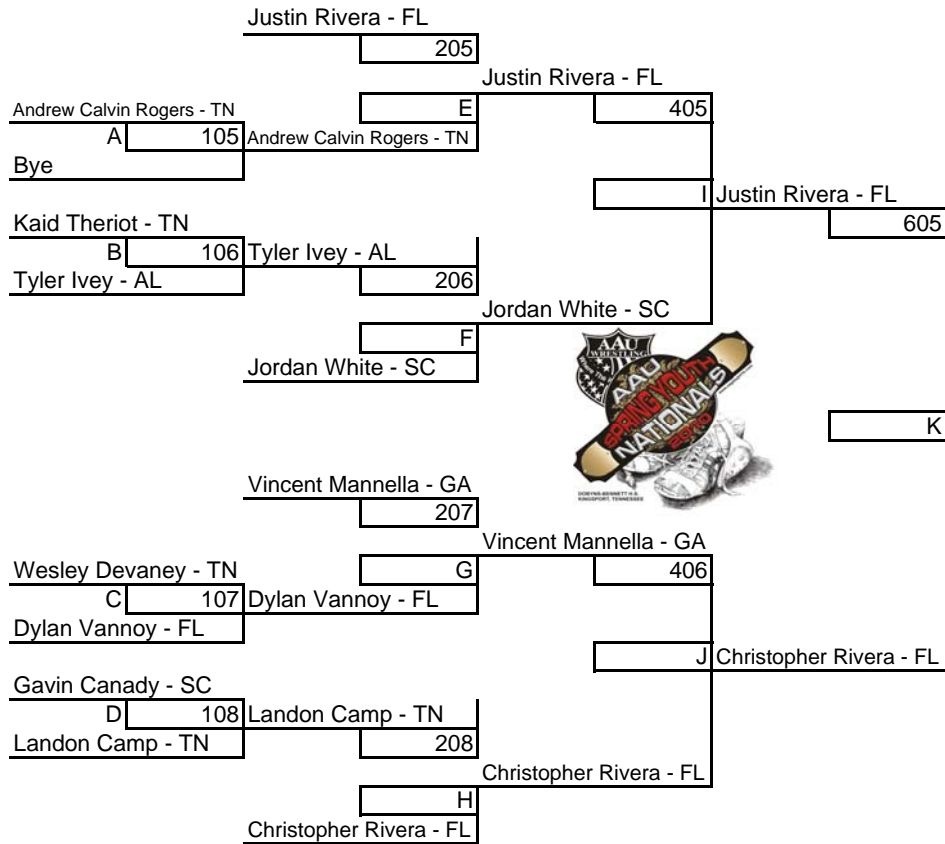

Round 3

Round 4

Round 5

Round 6

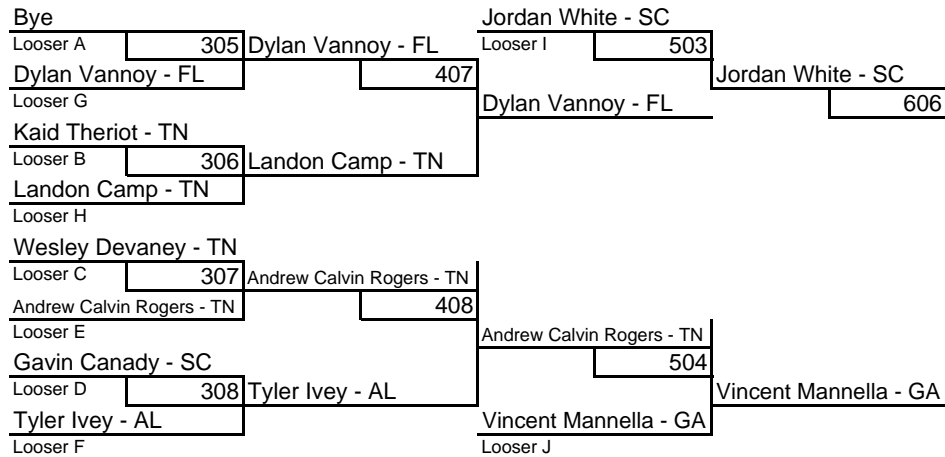

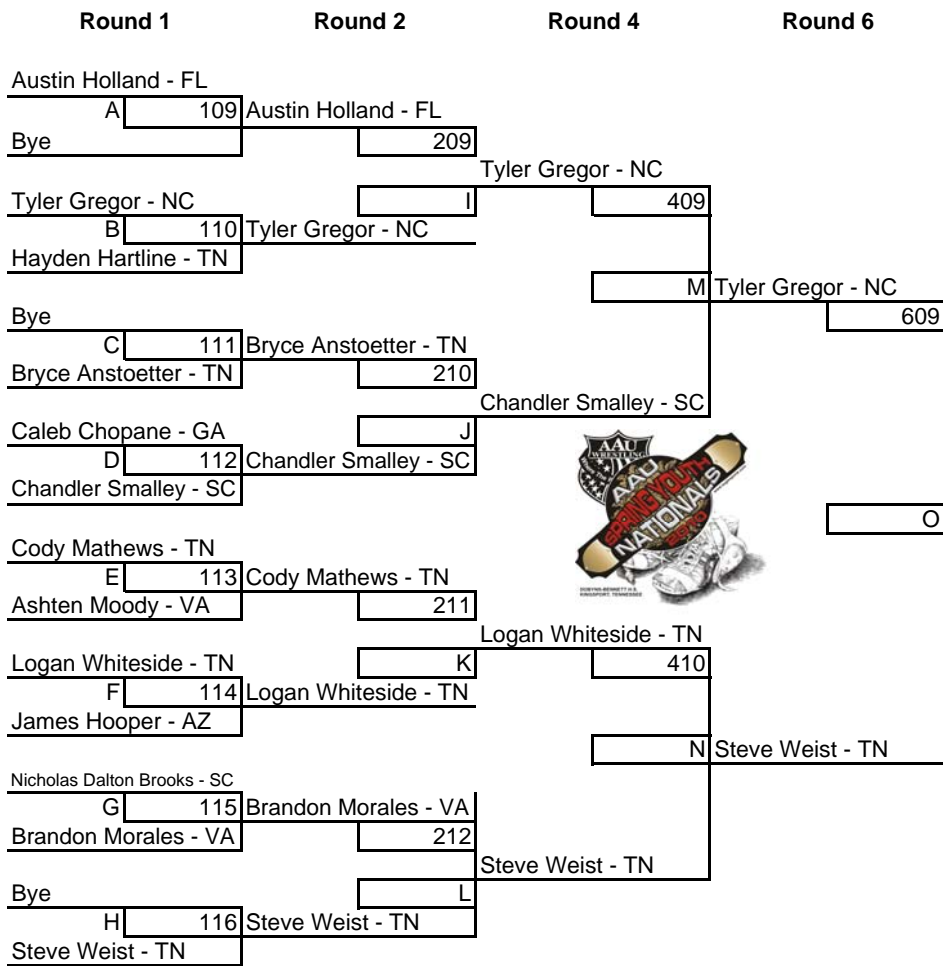

Weight: **60**

Class: **Midget**

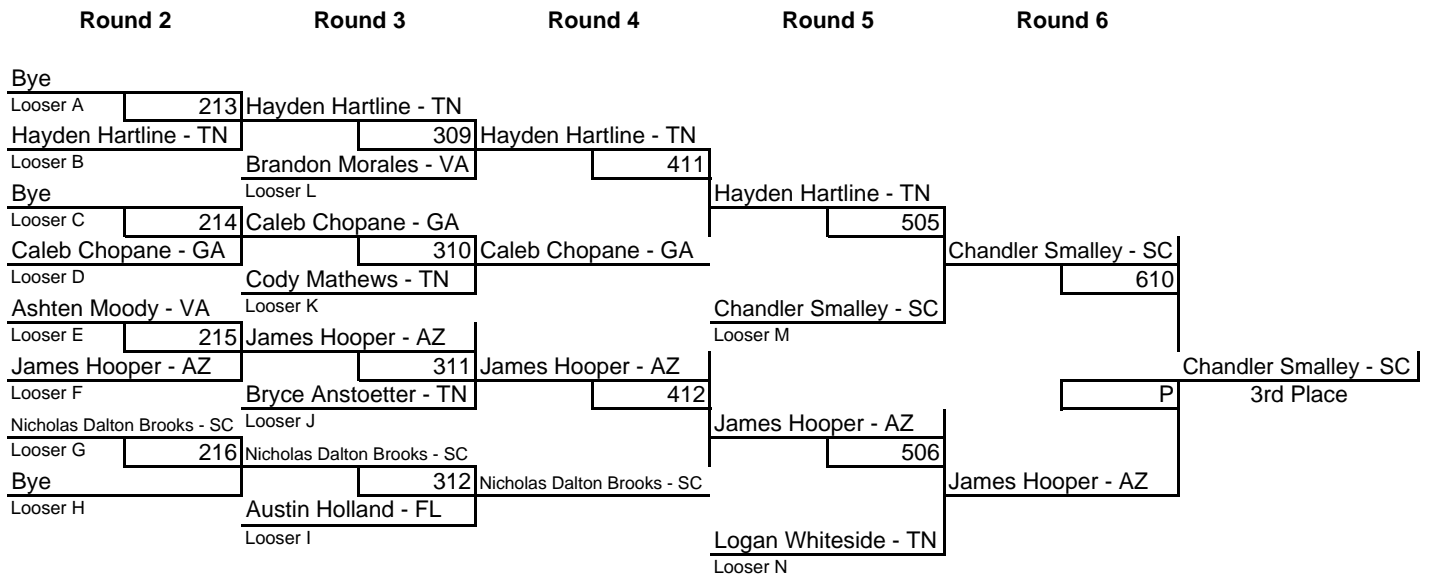
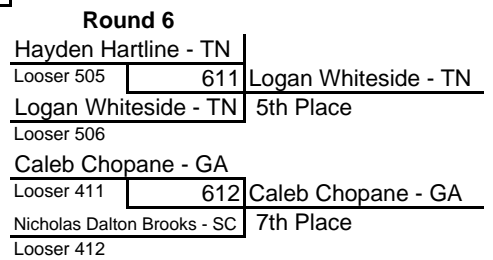

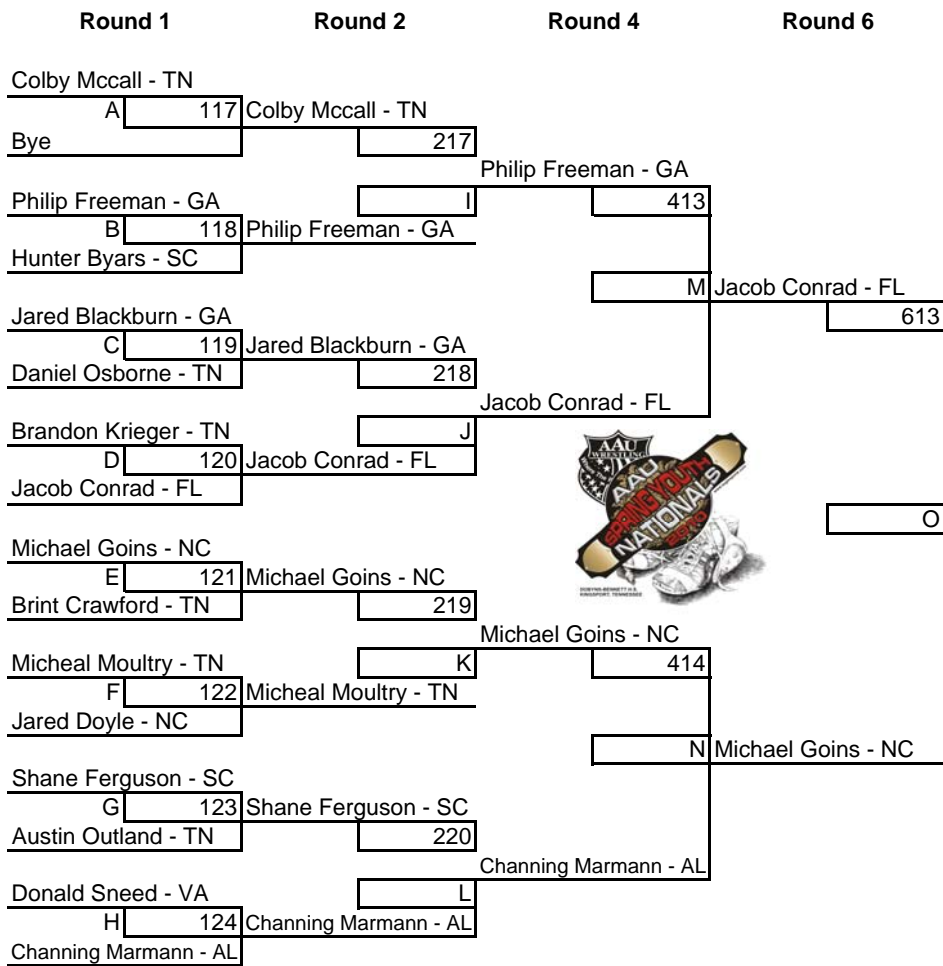

Weight: **65**

Class: **Midget**

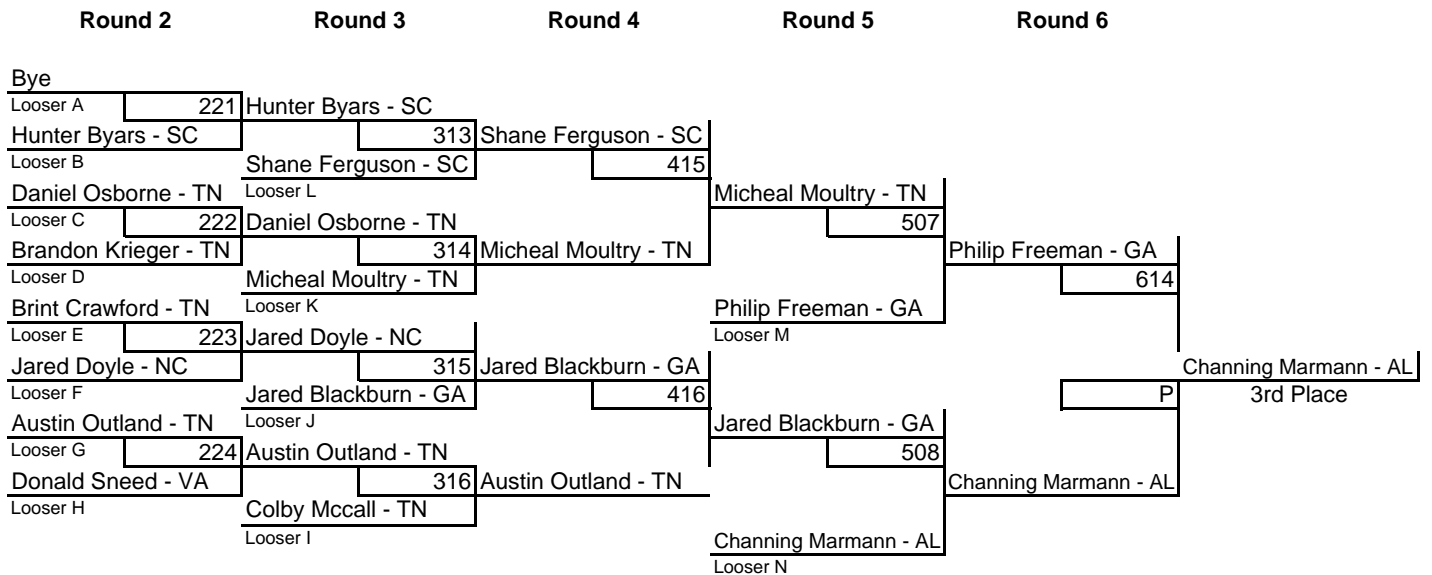
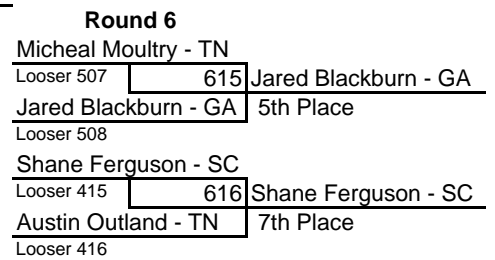

Round 1

Round 2

Round 4

Round 6

Weight: **70**

Class: **Midget**

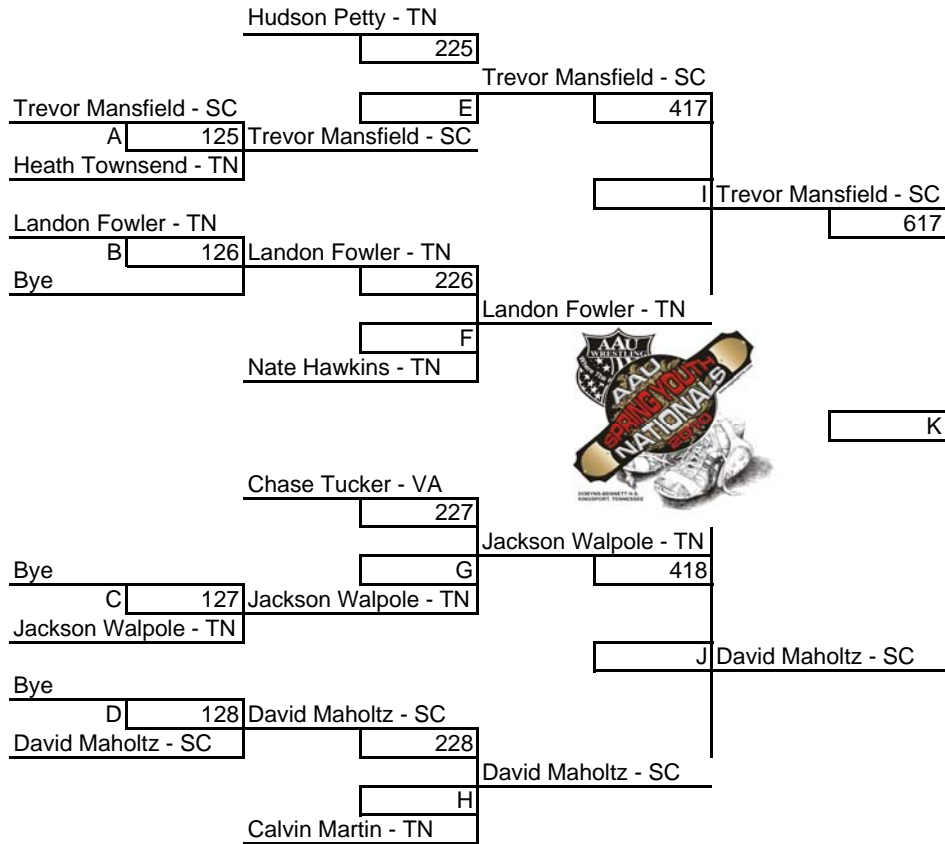

Trevor Mansfield - SC
Champion

Round 6

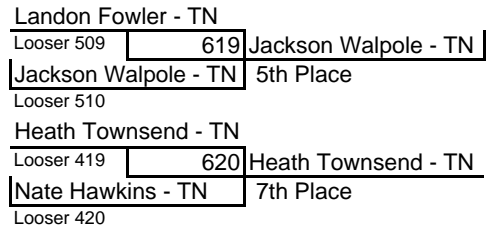

Round 3

Round 4

Round 5

Round 6

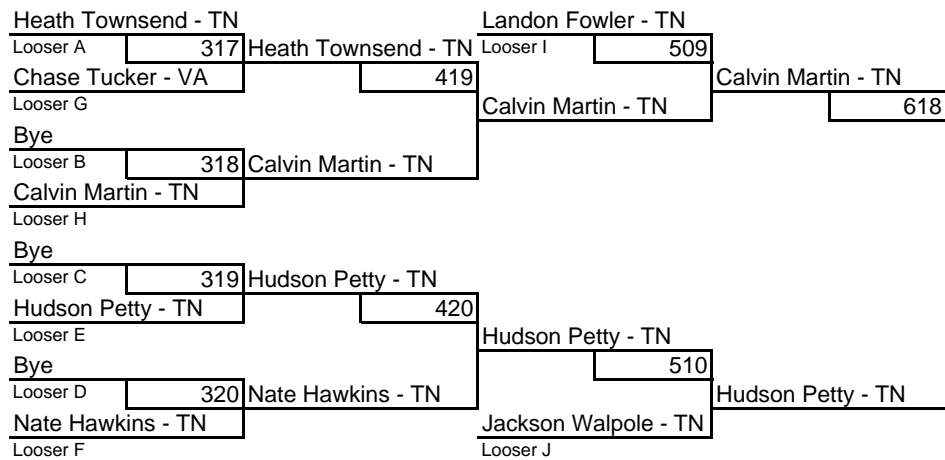

Hudson Petty - TN
3rd Place

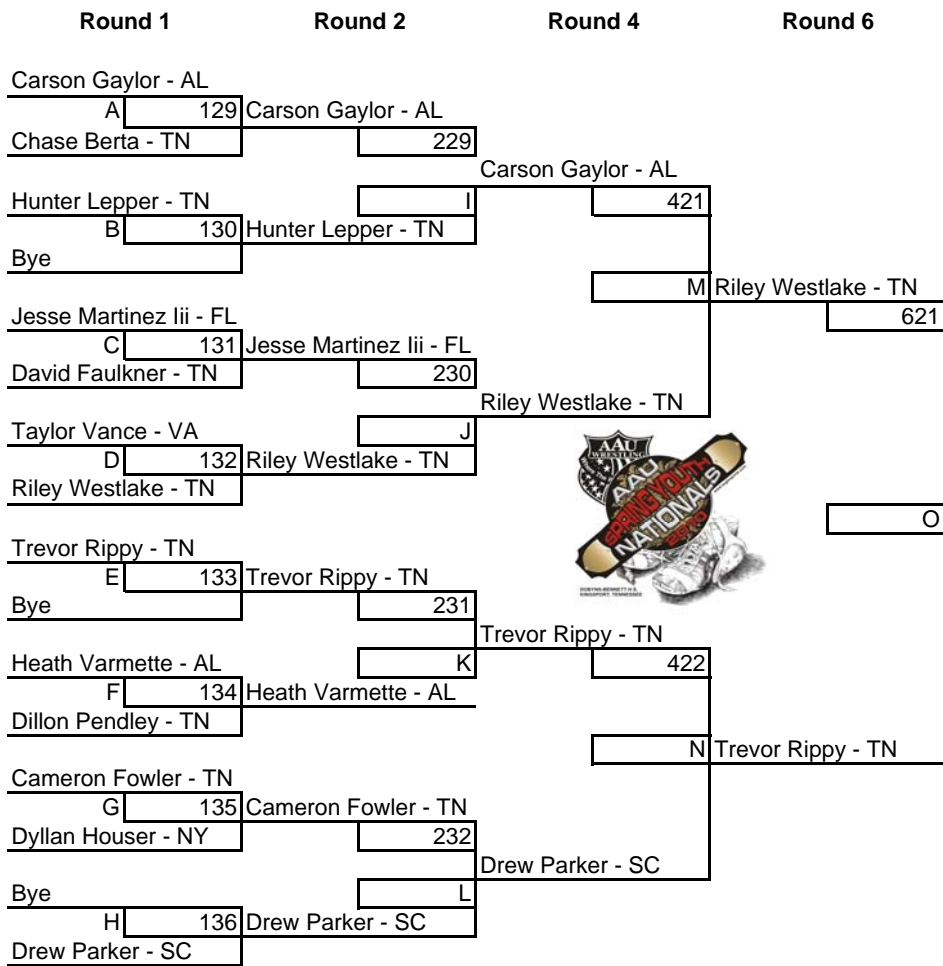

Weight: **75**

Class: **Midget**

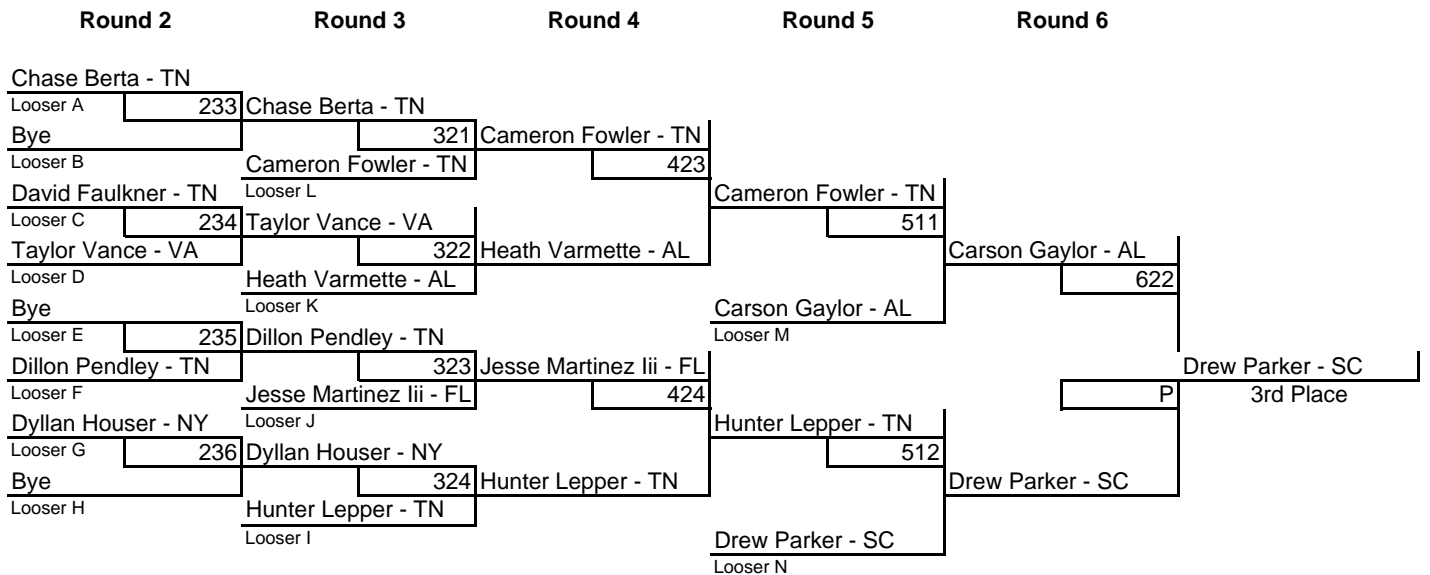
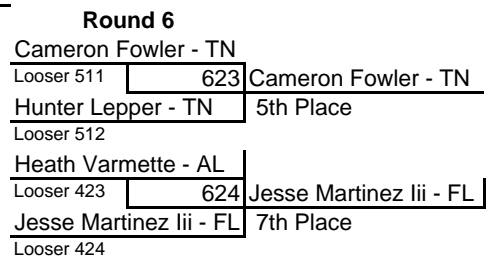

Round 1

Round 2

Round 4

Round 6

Weight: **80**

Class: **Midget**

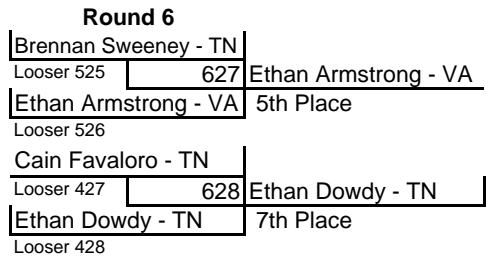
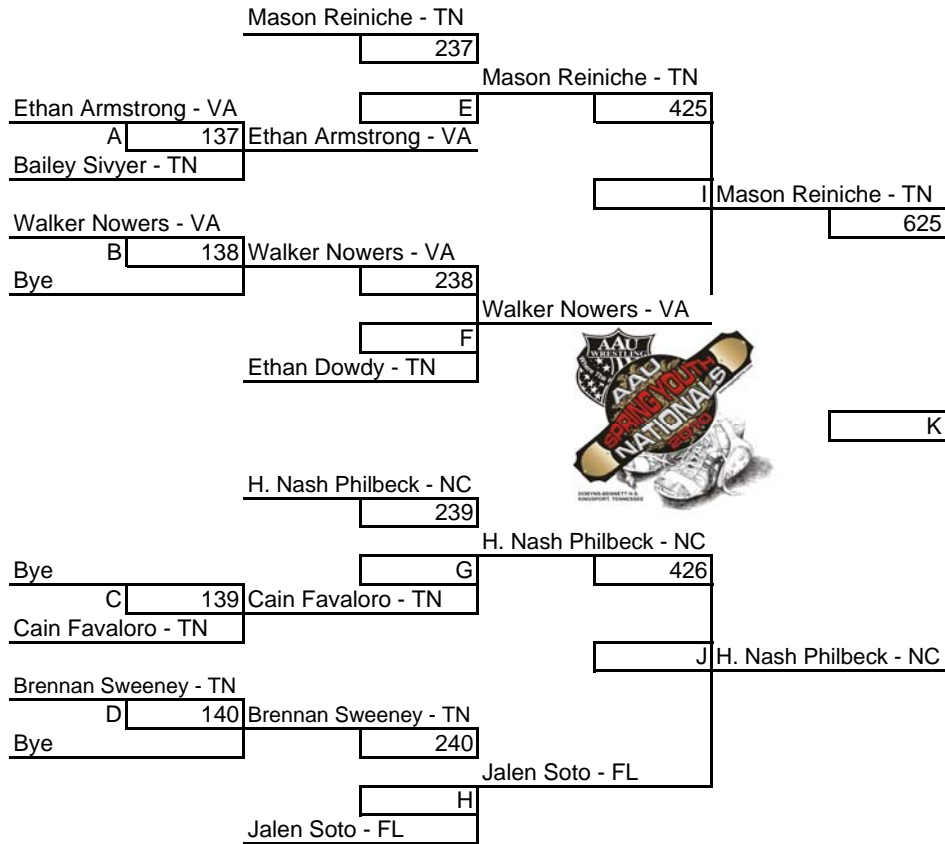

Round 3

Round 4

Round 5

Round 6

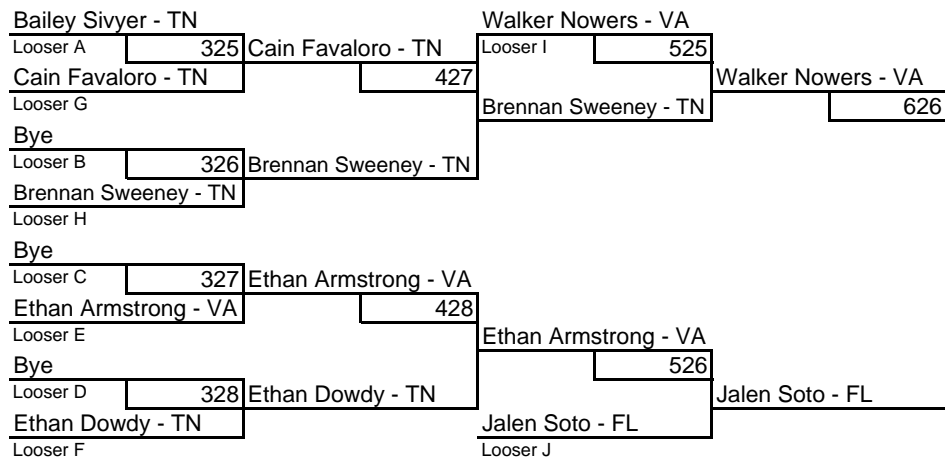

Round 1

Round 2

Round 4

Round 6

Weight: **85**

Class: **Midget**

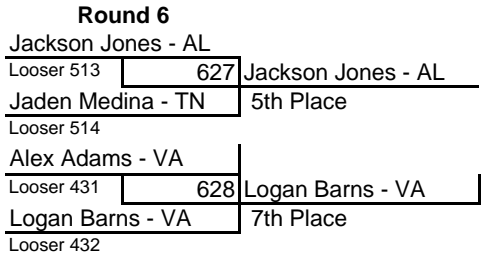
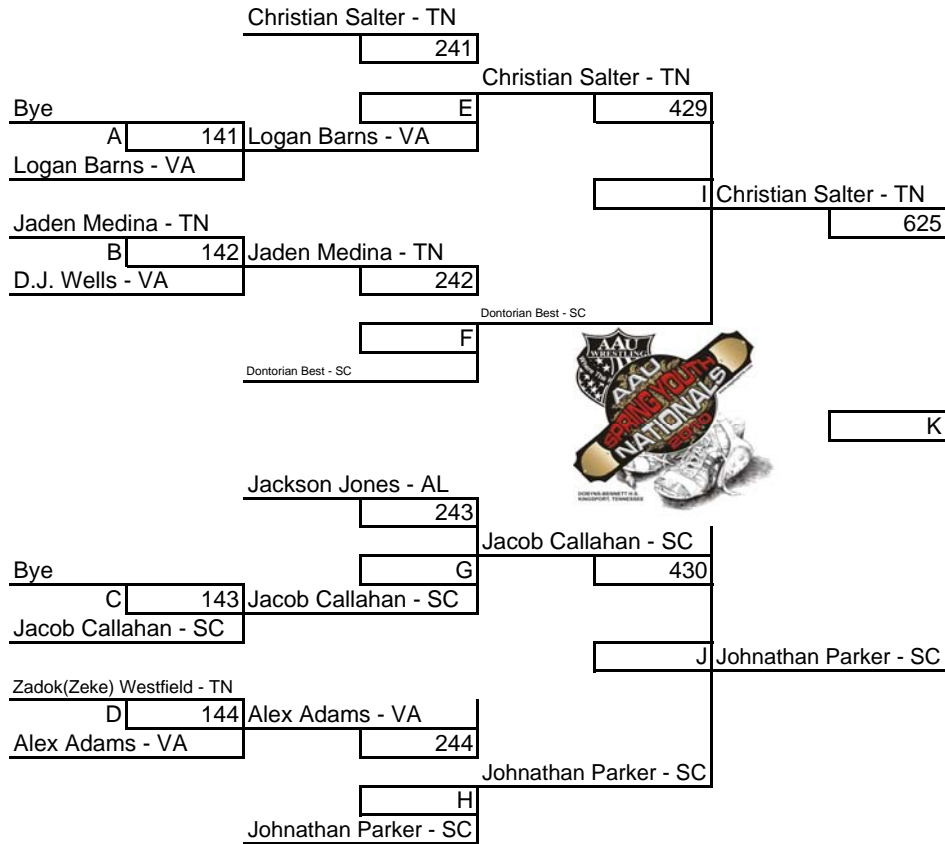

Round 3

Round 4

Round 5

Round 6

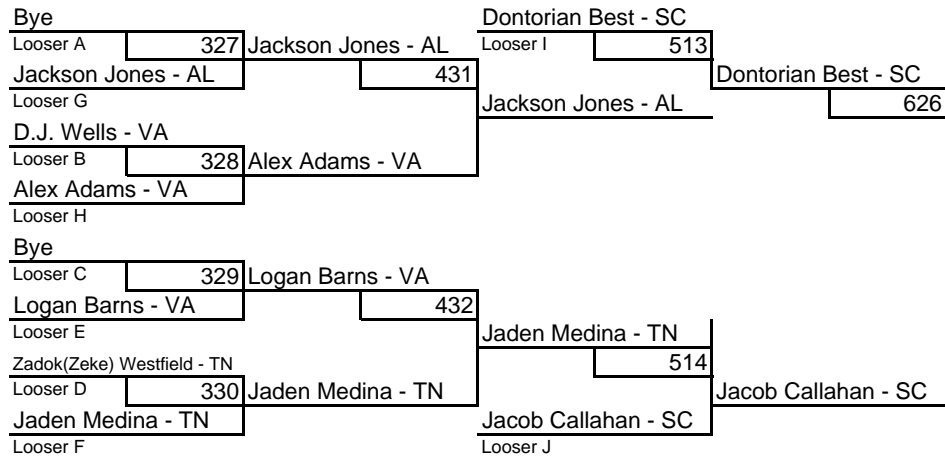

Jacob Callahan - SC
3rd Place

Class:

Midget

Weight:

90

Round 4

Round 3

Round 2

Round 1

Round 2

Round 4

Casey Bush - VA
3rd Place

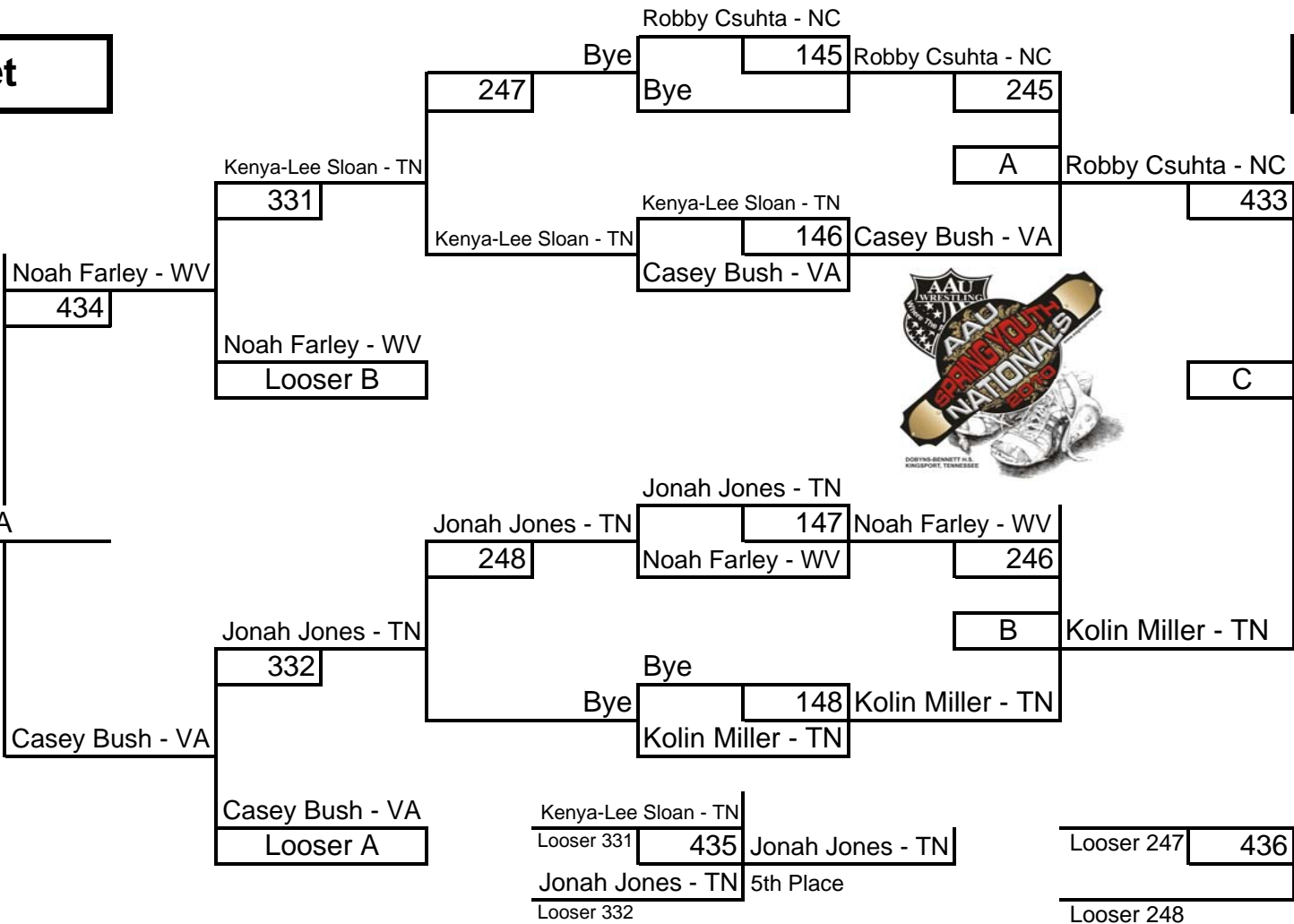

Robby Csuhtha -
Champion

7th Place

Round 1

1 Michael Hunt - SC
 _____ 149

 Michael Hunt - SC
 2 Josh Teaster - TN

3 Storm Curl - GA
 _____ 150

 Storm Curl - GA
 4 Bye

Round 2

1 Michael Hunt - SC
 _____ 249

 Michael Hunt - SC
 3 Storm Curl - GA

2 Josh Teaster - TN
 _____ 250

 Josh Teaster - TN
 5 Bye

Round 3

1 Michael Hunt - SC
 _____ 333

 Michael Hunt - SC
 4 Bye

2 Josh Teaster - TN
 _____ 334

 Josh Teaster - TN
 6 Storm Curl - GA

PL	Name	Wins	Losses
1	Michael Hunt - SC	2	0
2	Josh Teaster - TN	1	1
3	Storm Curl - GA	0	2



- 1 Michael Hunt - SC
- 2 Josh Teaster - TN
- 3 Storm Curl - GA
- 4 _____

Class Midget

Weight 95

Round 1

1 Ryan Heath - TN
 151
 Ryan Heath - TN
 2 Austin Wyatt - VA

Round 2

1 Ryan Heath - TN
 251
 Ryan Heath - TN
 2 Austin Wyatt - VA

**Round 3
If Needed**

1 Ryan Heath - TN
 335
 2 Austin Wyatt - VA

Best 2 out of 3

	Name	Wins	Losses
1	Ryan Heath - TN	2	0
2	Austin Wyatt - VA	0	2

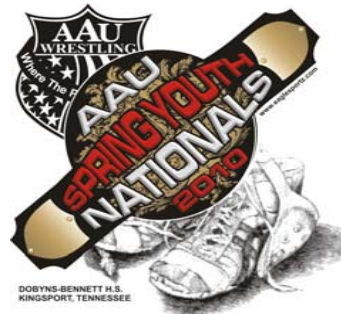

- 1 Ryan Heath - TN
- 2 Austin Wyatt - VA
- 3 _____
- 4 _____

Class Midget

Weight 103

Round 1

1 Coale Gamble - TN
 _____ 155

 2 Michael Kramer - TN

 _____ Michael Kramer - TN

Round 2

1 Coale Gamble - TN
 _____ 255

 3 Michael Kramer - TN

 _____ Michael Kramer - TN

**Round 3
 If Needed**

1 Coale Gamble - TN
 _____ 339

 4 Michael Kramer - TN

Best 2 out of 3

PL	Name	Wins	Losses
2	Coale Gamble - TN	0	2
1	Michael Kramer - TN	2	0

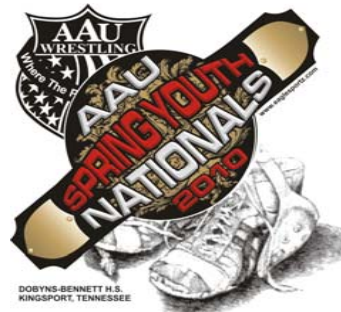

1 Michael Kramer - TN
 2 Coale Gamble - TN
 3 _____
 4 _____

Class Midget

Weight 112

Round 1

1 Keenan Sloan - TN

2 Bye

3 Bye

4 Bye

Round 2

1 Keenan Sloan - TN

3 Bye

2 Bye

5 Bye

Round 3

1 Keenan Sloan - TN

4 Bye

2 Bye

6 Bye

	Name	Wins	Losses
1	Keenan Sloan - TN		
2			
3			
4			

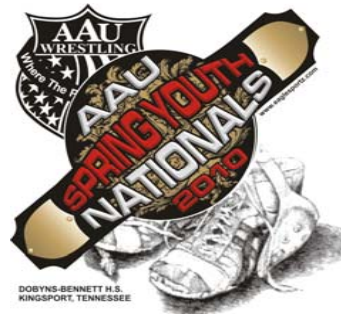

- 1
- 2 _____
- 3 _____
- 4 _____

Class

Weight

Round 1

1 Thomas Roberts - TN
 _____ 159
 _____ Thomas Roberts - TN
 2 Dylan Weaver - TN

3 Keenan Sloan - TN
 _____ 160
 _____ Keenan Sloan - TN
 4 Bye

Round 2

1 Thomas Roberts - TN
 _____ 259
 _____ Thomas Roberts - TN
 3 Keenan Sloan - TN

2 Dylan Weaver - TN
 _____ 260
 _____ Dylan Weaver - TN
 5 Bye

Round 3

1 Thomas Roberts - TN
 _____ 343
 _____ Thomas Roberts - TN
 4 Bye

2 Dylan Weaver - TN
 _____ 344
 _____ Keenan Sloan - TN
 6 Keenan Sloan - TN

PL	Name	Wins	Losses
1	Thomas Roberts - TN	3	0
3	Dylan Weaver - TN	0	3
2	Keenan Sloan - TN	2	1



- 1 Thomas Roberts - TN
- 2 Keenan Sloan - TN
- 3 Dylan Weaver - TN
- 4 _____

Class Midget

Weight HWT

Round 1

Round 2

Round 4

Round 6

Weight: **60**

Class: **Novice**

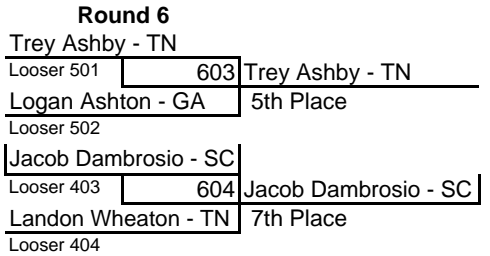
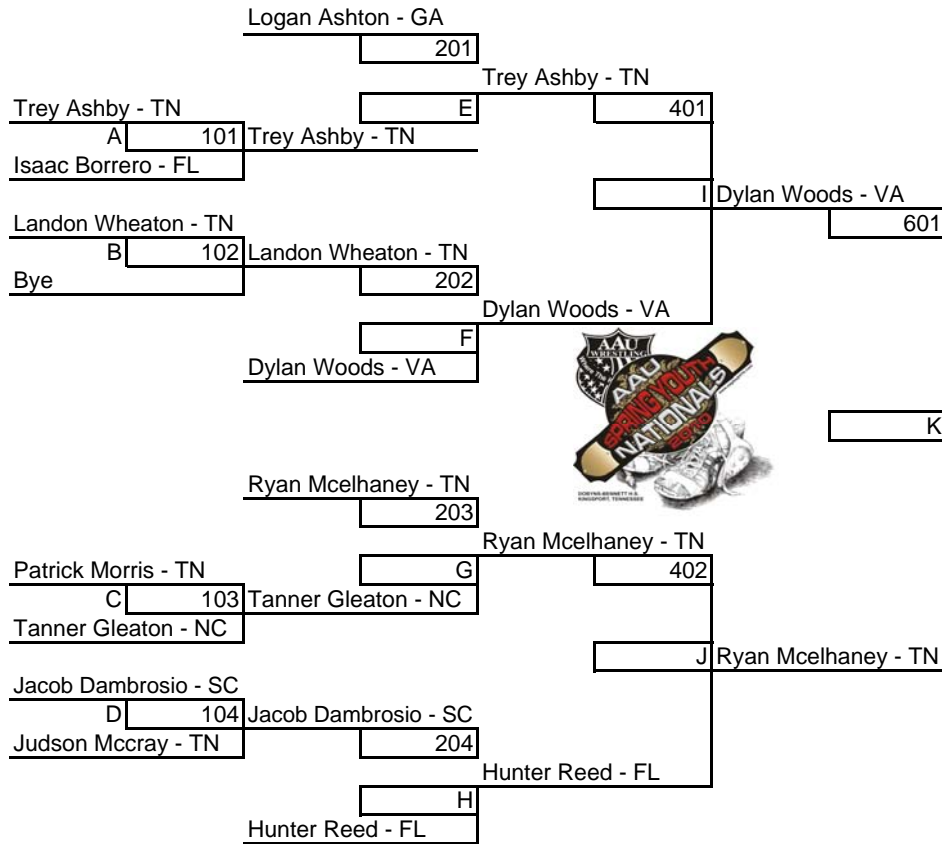

Round 3

Round 4

Round 5

Round 6

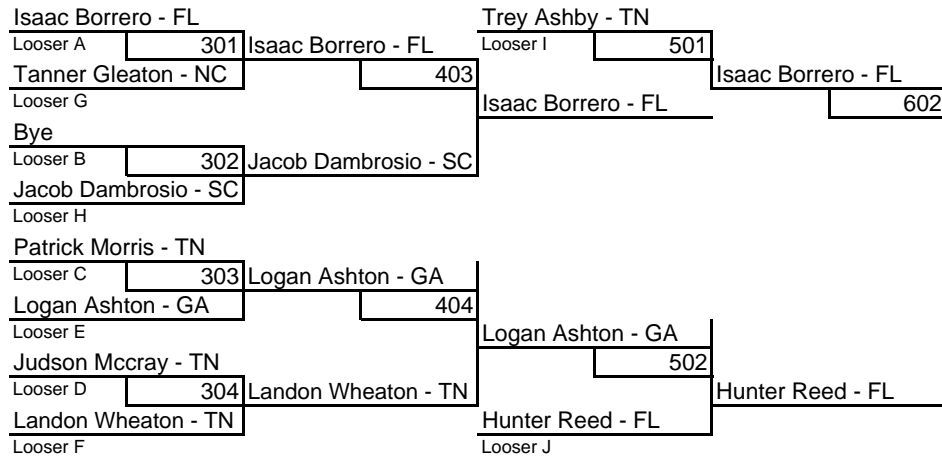

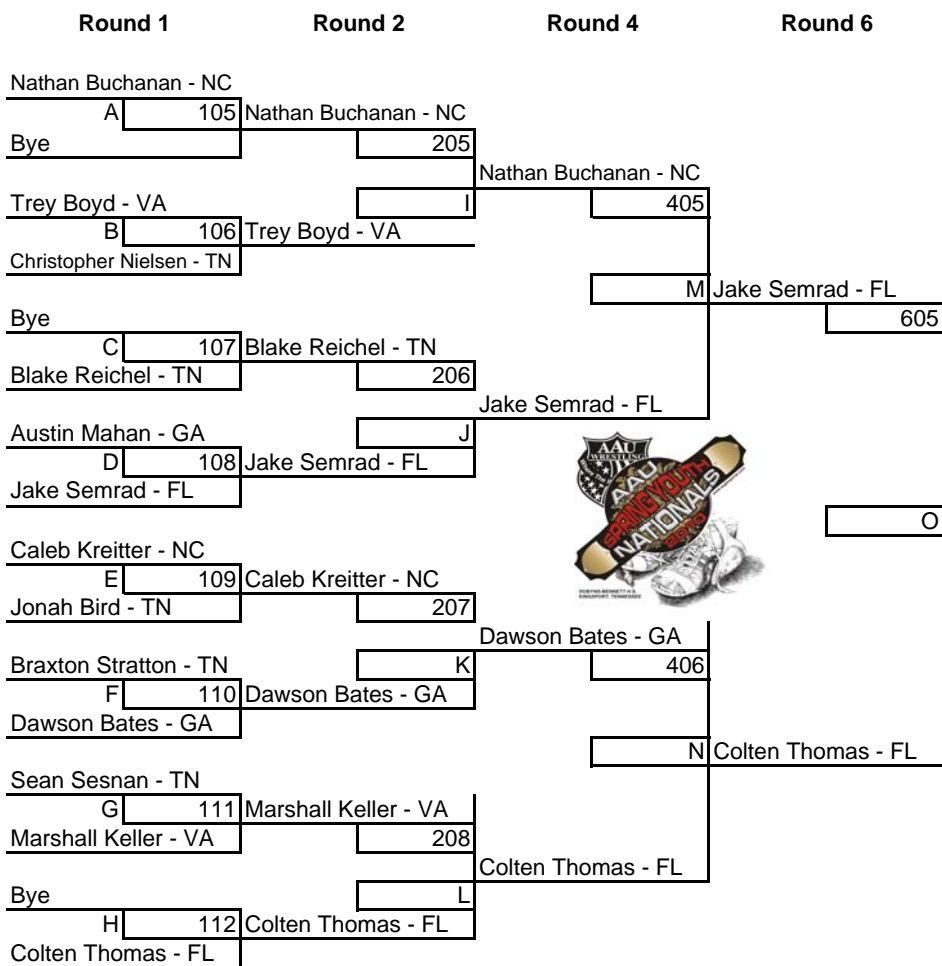

Weight: **65**

Class: **Novice**

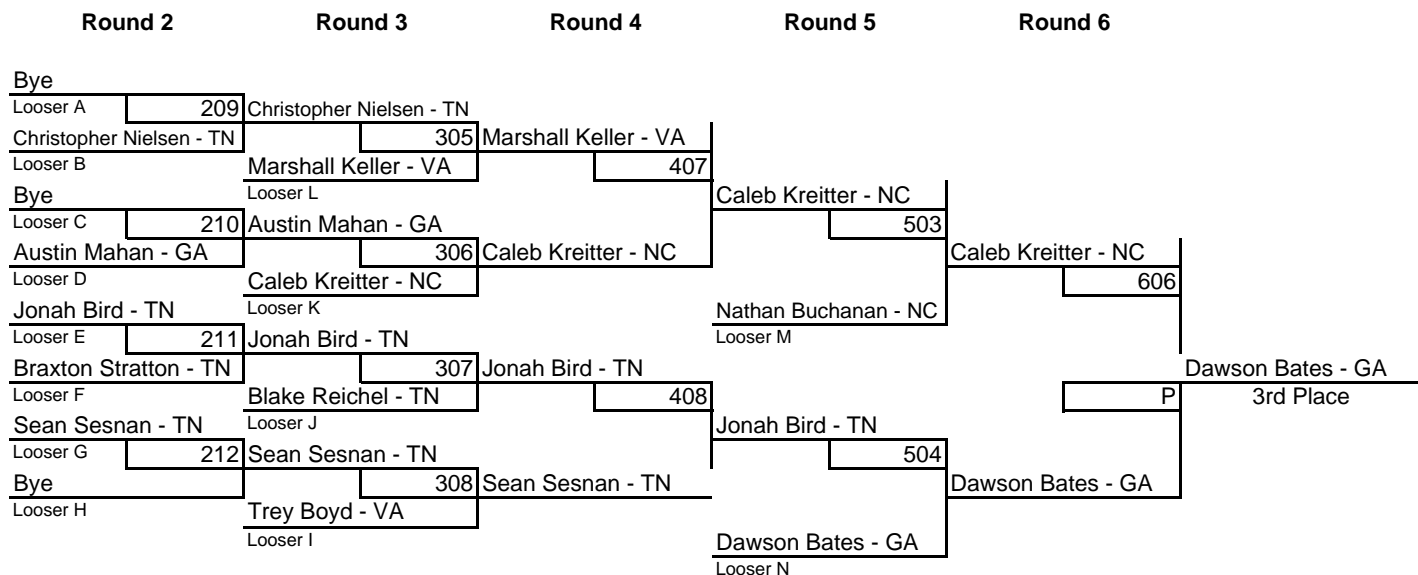
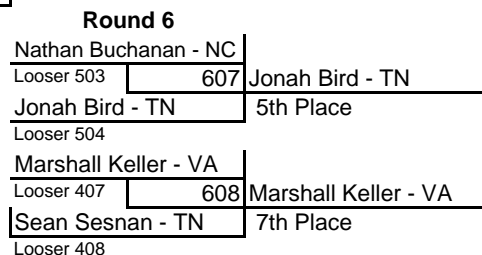

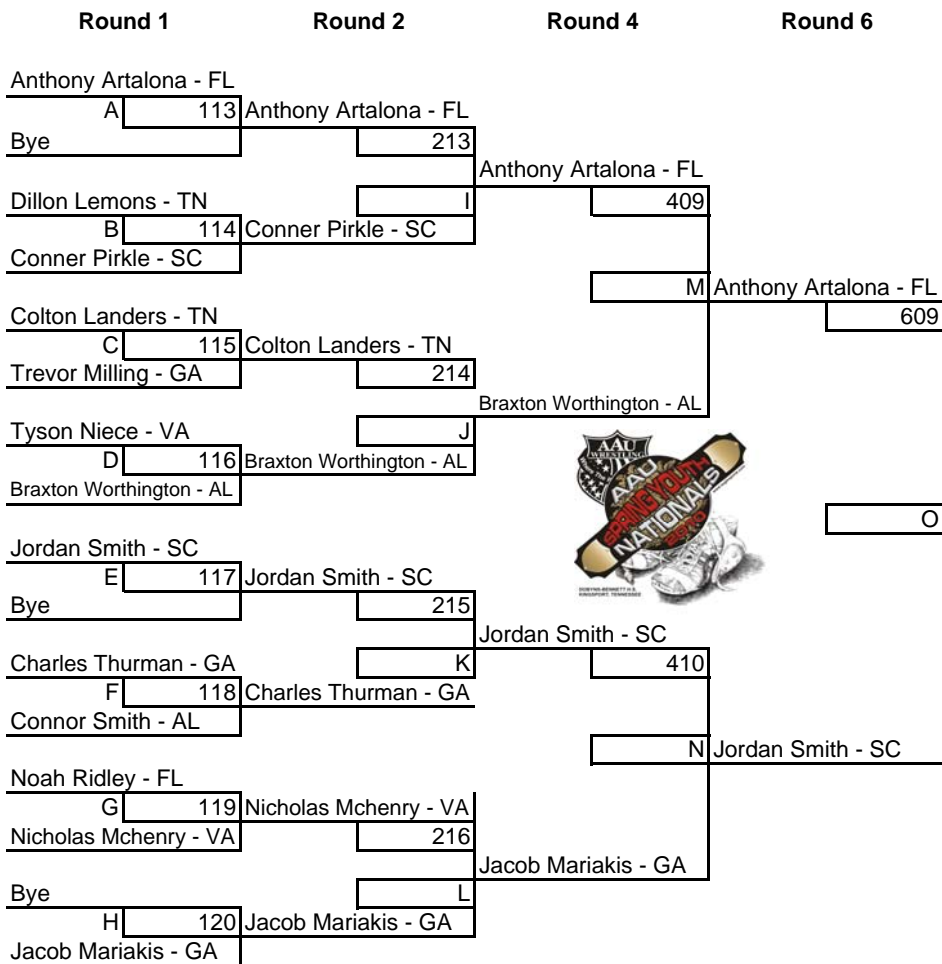

Weight: **70**

Class: **Novice**

O Anthony Artalona - FL
Champion

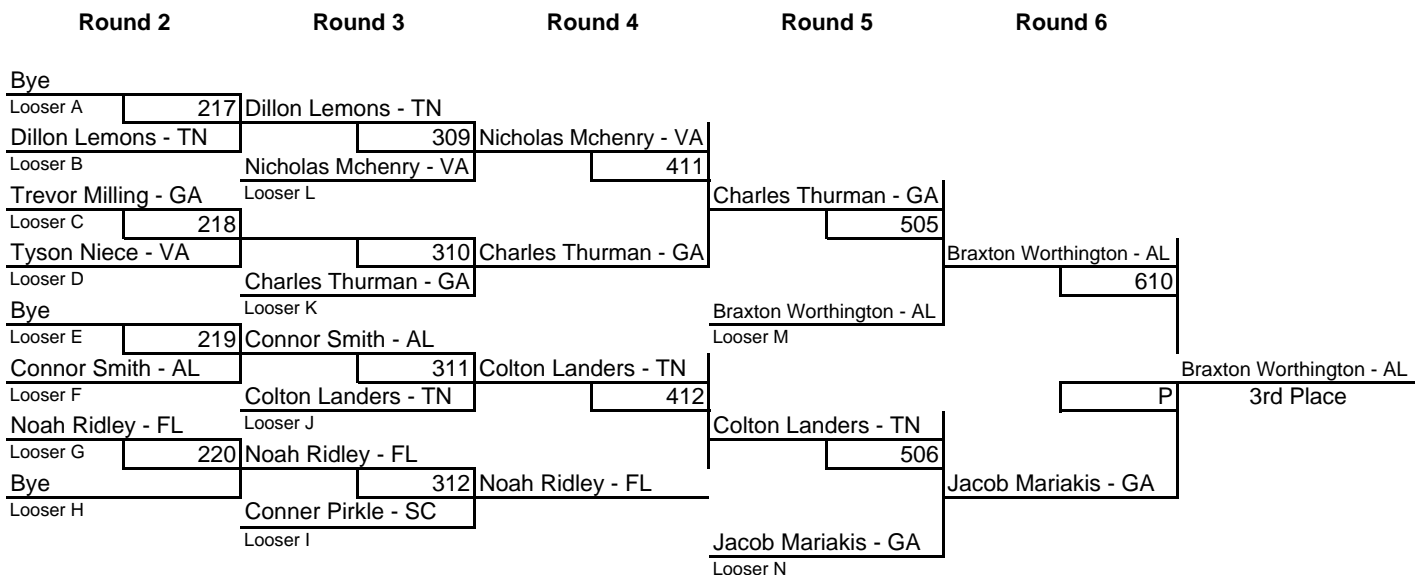
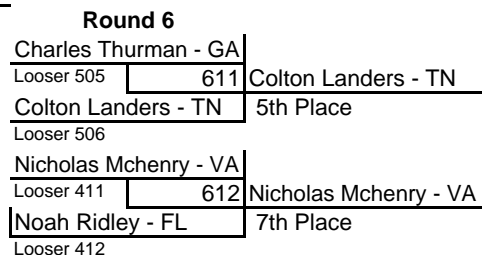

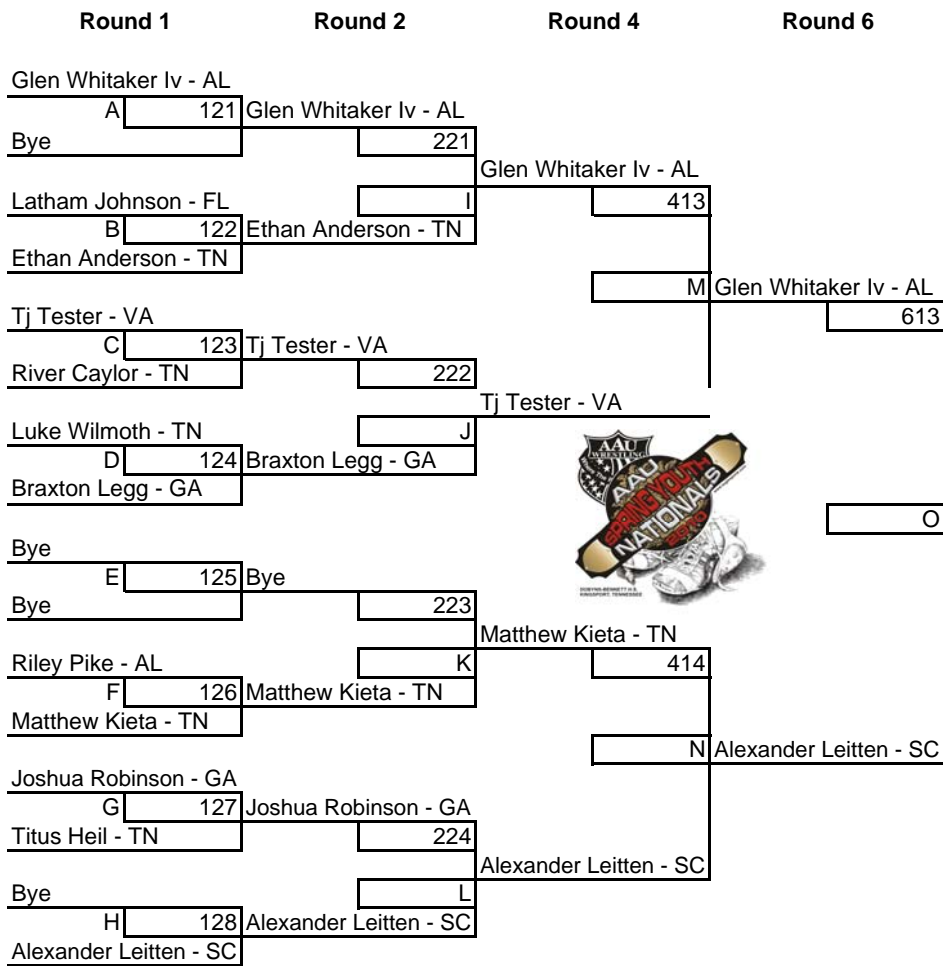

Weight: **75**

Class: **Novice**



Alexander Leitten - SC
Champion

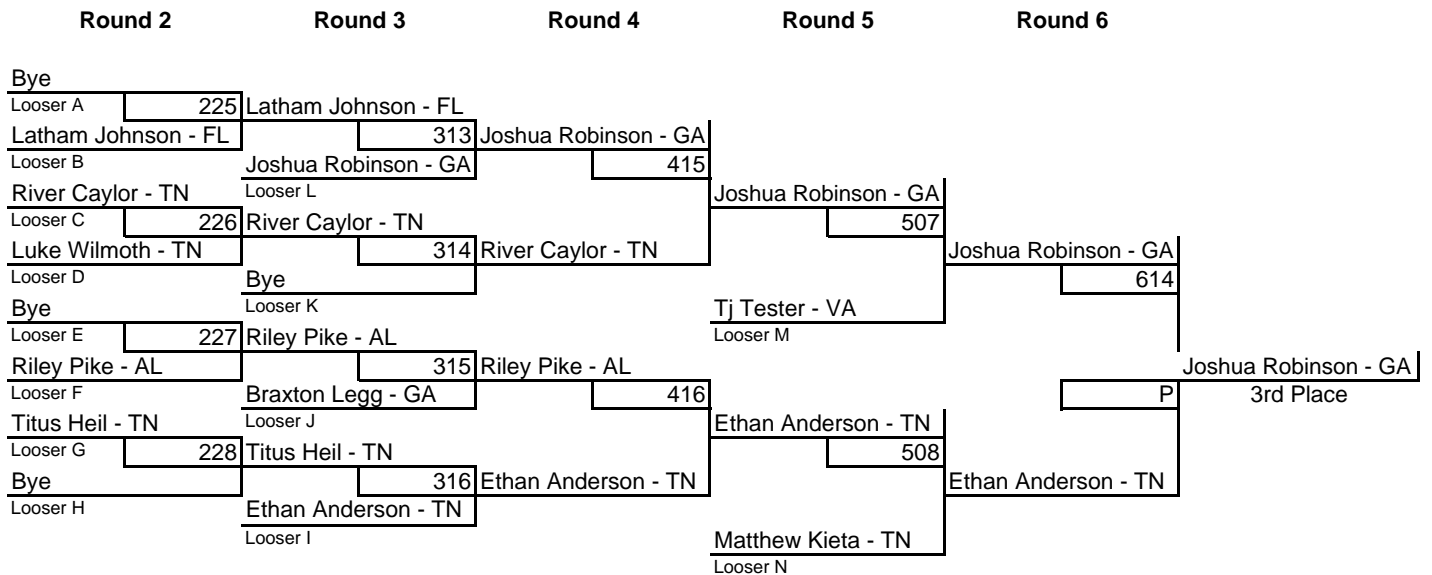
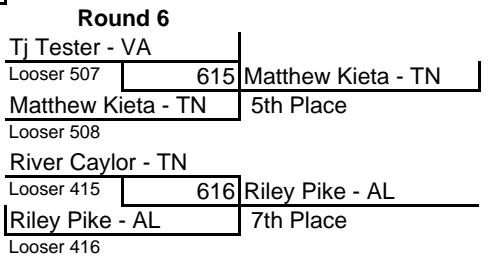

Round 1

Round 2

Round 4

Round 6

Weight: **80**

Class: **Novice**

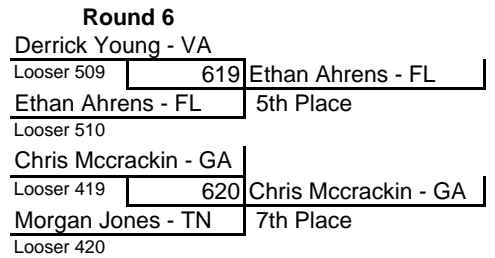
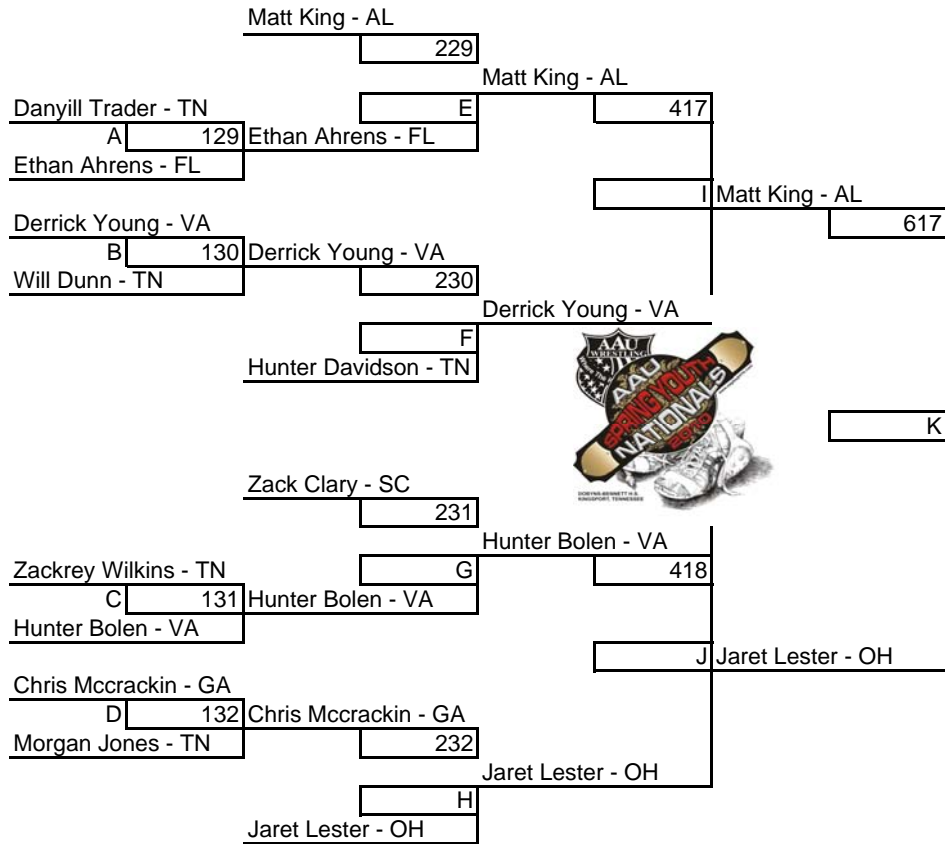

Round 3

Round 4

Round 5

Round 6

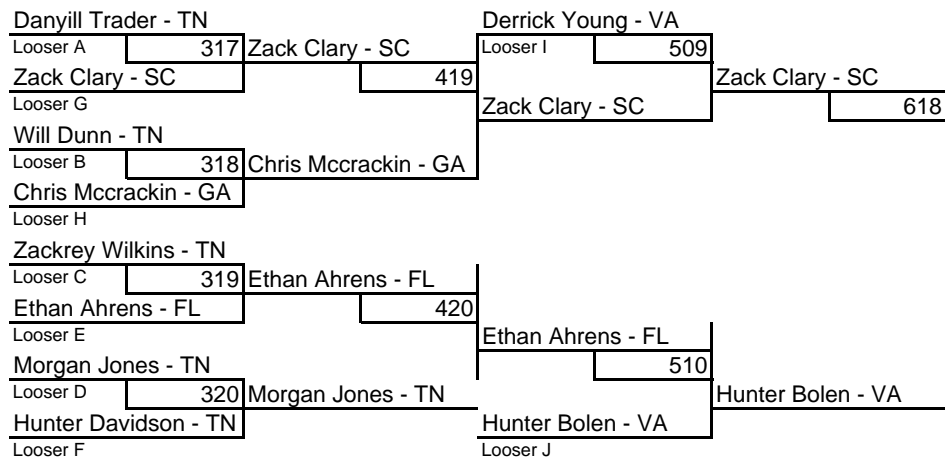

Zack Clary - SC
3rd Place

Class:

Novice

Weight:

85

Round 4

Round 3

Round 2

Round 1

Round 2

Round 4

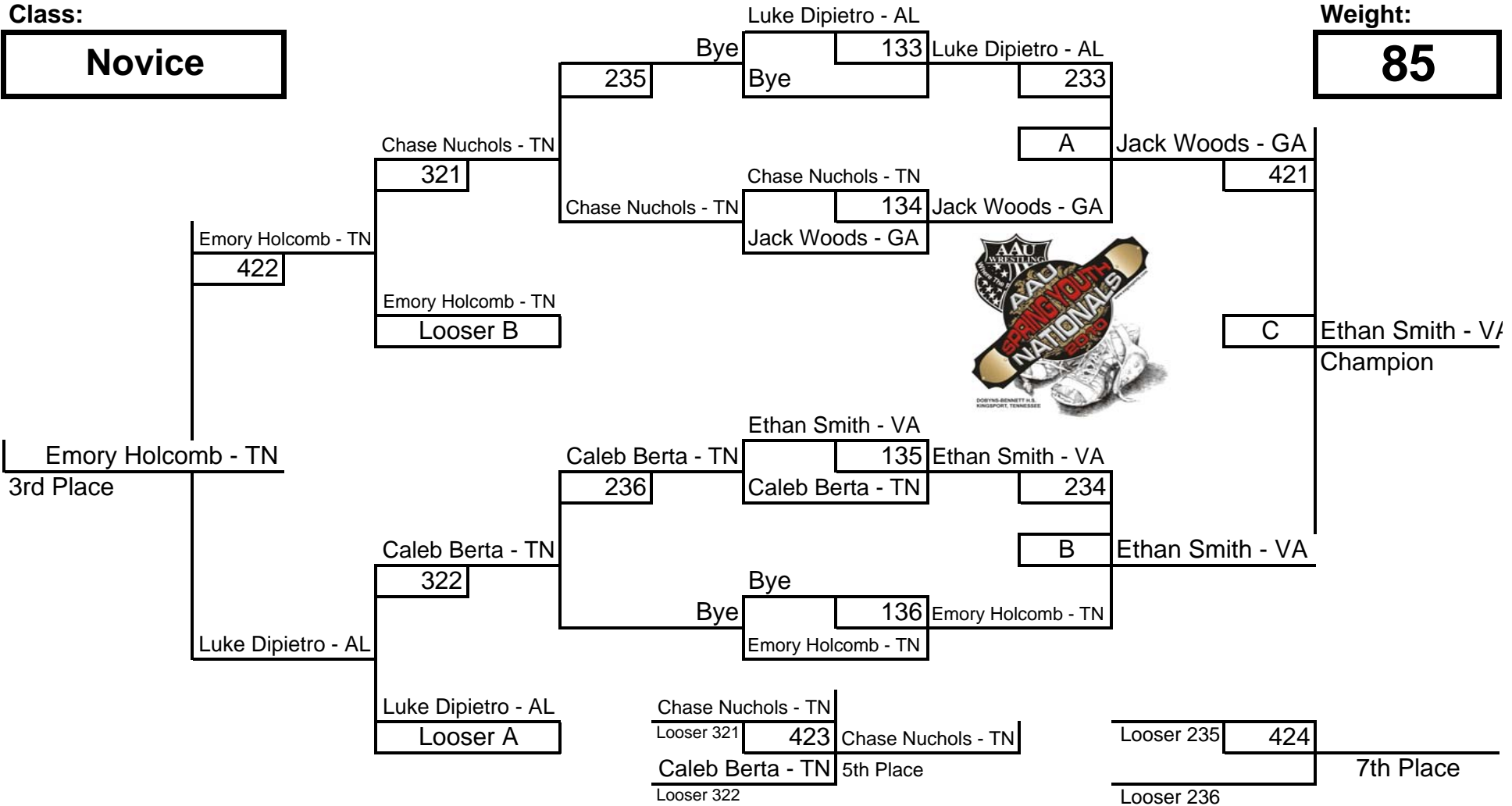

Round 1

Round 2

Round 4

Round 6

Weight: **90**

Class: **Novice**

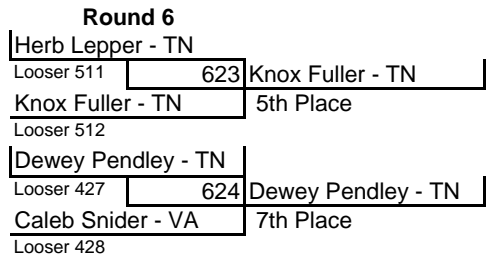
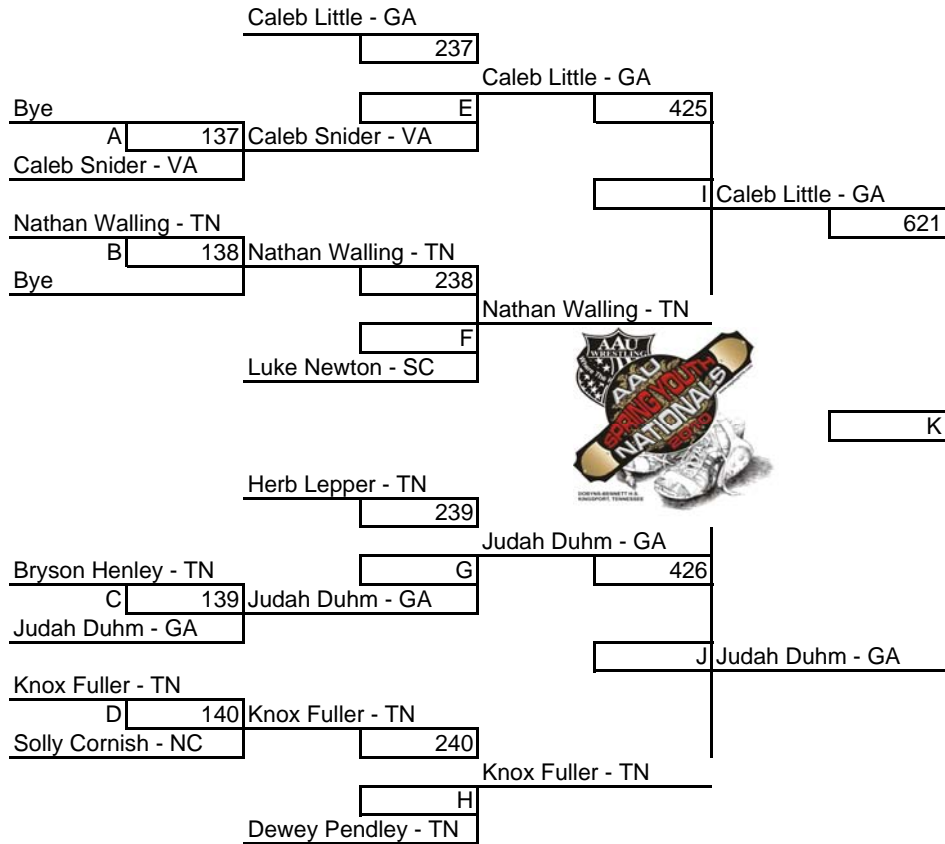

Round 3

Round 4

Round 5

Round 6

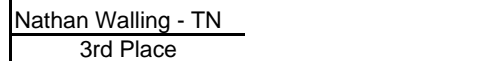
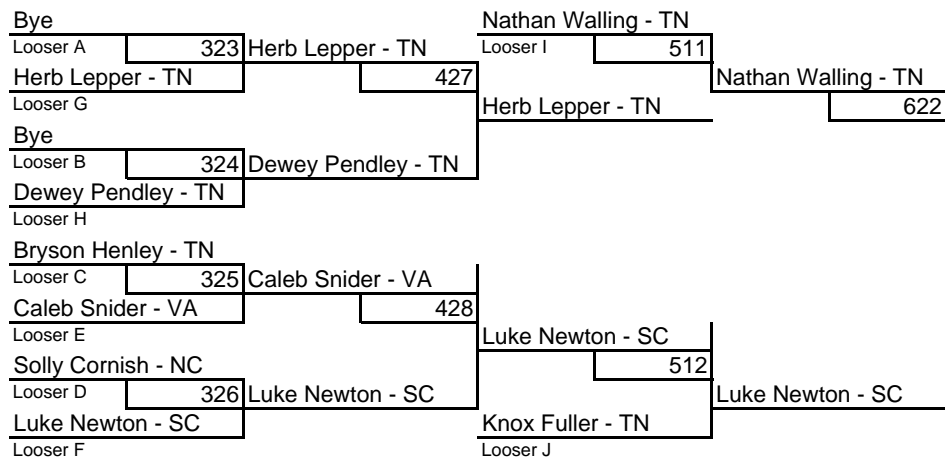

Round 1

Round 2

Round 4

Round 6

Weight: **95**

Class: **Novice**

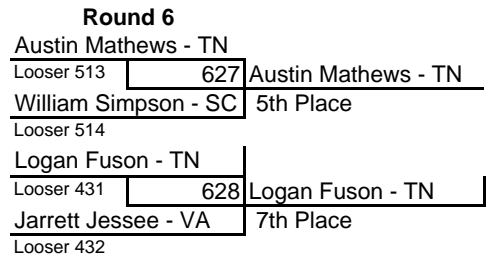
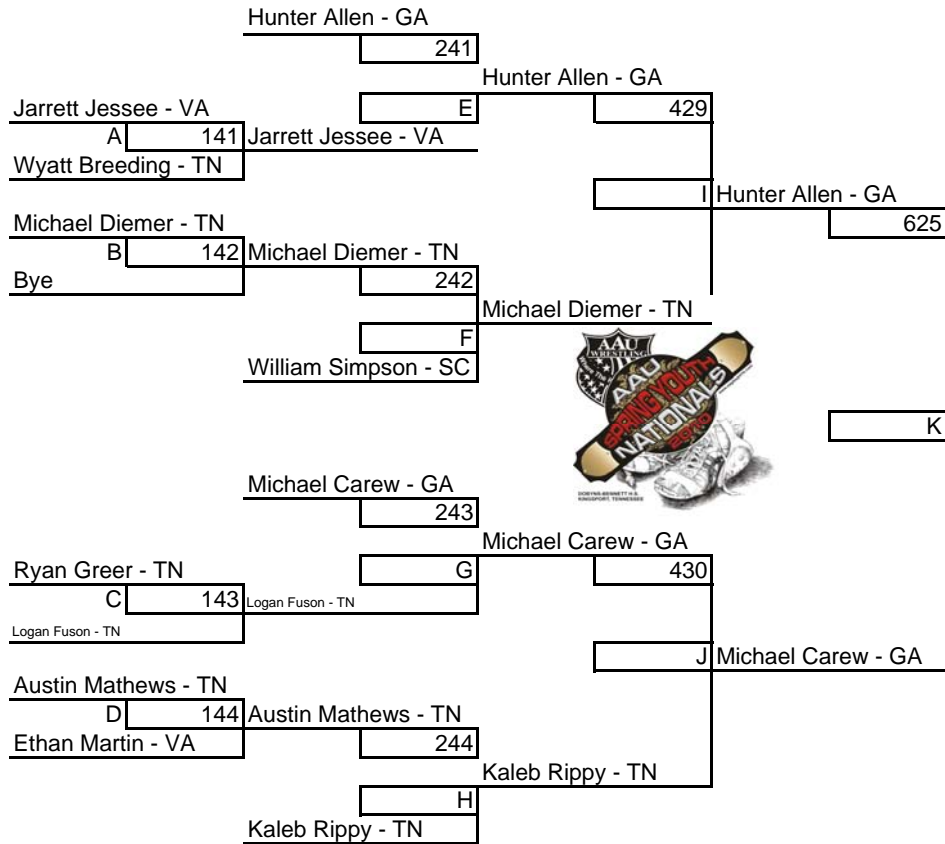

Round 3

Round 4

Round 5

Round 6

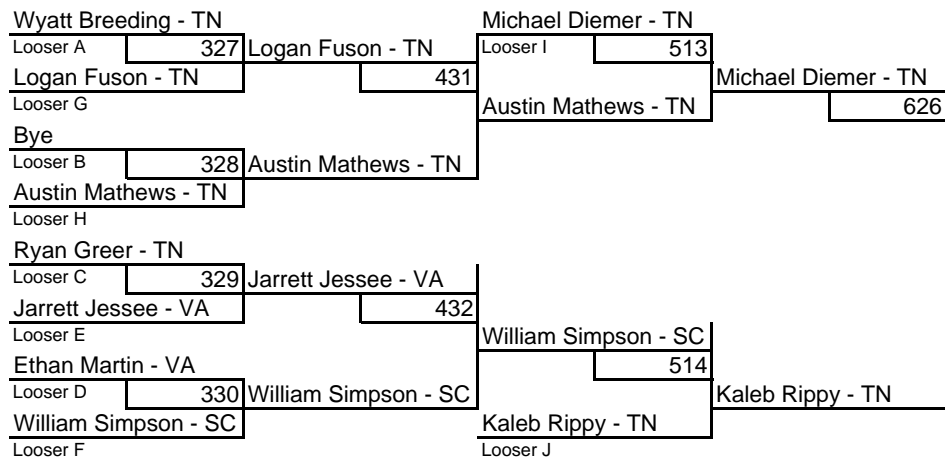

3rd Place

Round 1

Round 2

Round 4

Round 6

Weight: **100**

Class: **Novice**

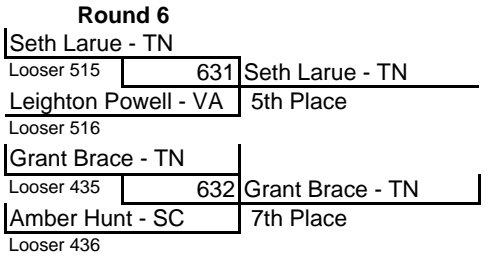
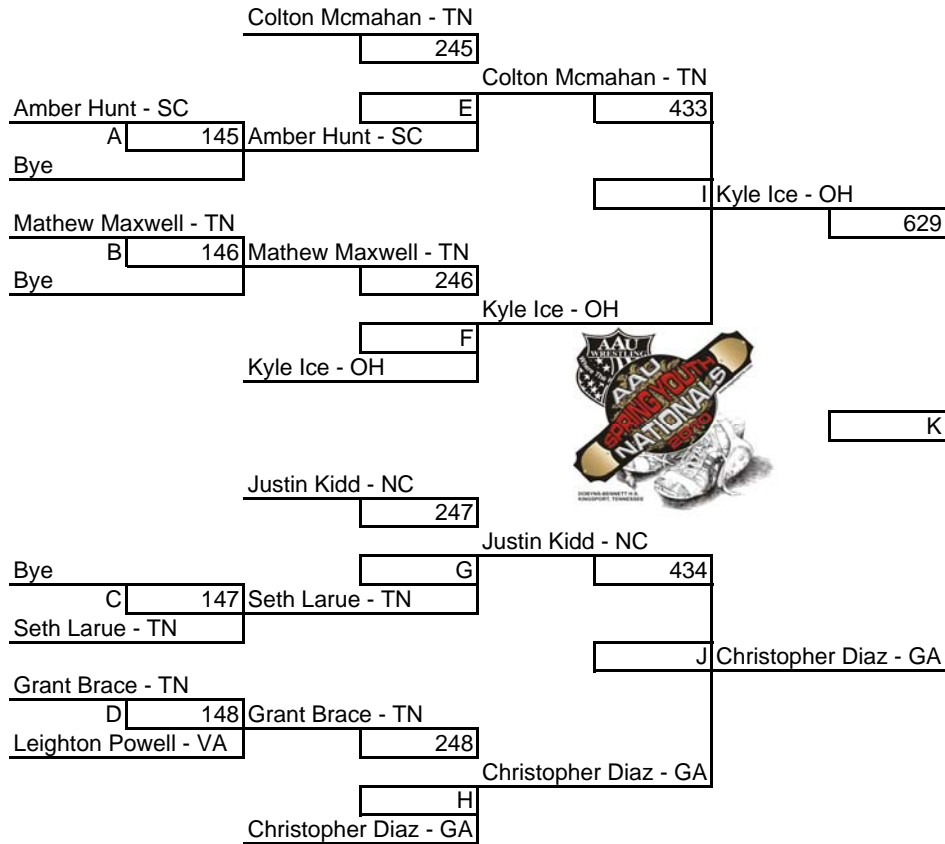

Round 3

Round 4

Round 5

Round 6

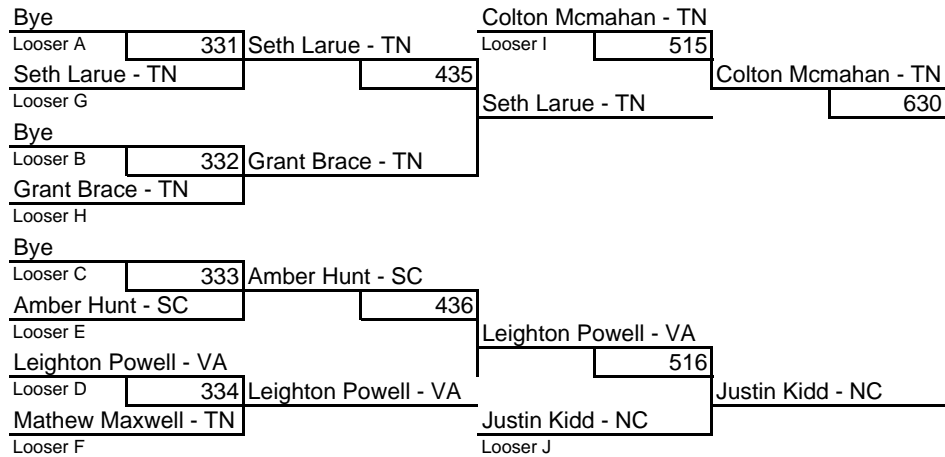

Round 1

1 Grant Swanner - NC
 149
 Grant Swanner - NC
 2 Corbin Hurley - TN

3 Jacob Noel - TN
 150
 Tristan Czadzeck - TN
 4 Tristan Czadzeck - TN

Round 2

1 Grant Swanner - NC
 249
 Grant Swanner - NC
 3 Jacob Noel - TN

2 Corbin Hurley - TN
 250
 Corbin Hurley - TN
 5 Tristan Czadzeck - TN

Round 3

1 Grant Swanner - NC
 335
 Grant Swanner - NC
 4 Tristan Czadzeck - TN

2 Corbin Hurley - TN
 336
 Corbin Hurley - TN
 6 Jacob Noel - TN

PL	Name	Wins	Losses
1	Grant Swanner - NC	3	0
2	Corbin Hurley - TN	2	1
4	Jacob Noel - TN	0	3
3	Tristan Czadzeck - TN	1	2

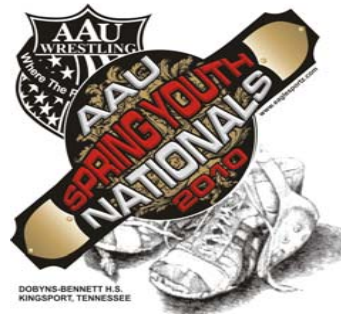

- 1 Grant Swanner - NC
- 2 Corbin Hurley - TN
- 3 Tristan Czadzeck - TN
- 4 Jacob Noel - TN

Class Novice

Weight 105

Round 1

- 1 Giovanny Adan - AL
151
Blaze Kansco - GA
- 2 Blaze Kansco - GA
- 3 Jordan Thompson - VA
152
Jordan Thompson - VA
- 4 Truman Ross - TN
- 5 Logan Morris - VA
153
Logan Morris - VA
- 6 Bye

Round 2

- 1 Giovanny Adan - AL
251
Jordan Thompson - VA
- 3 Jordan Thompson - VA
- 2 Blaze Kansco - GA
252
Blaze Kansco - GA
- 5 Logan Morris - VA
- 4 Truman Ross - TN
253
Truman Ross - TN
- 6 Bye

Round 3

- 1 Giovanny Adan - AL
337
Truman Ross - TN
- 4 Truman Ross - TN
- 2 Blaze Kansco - GA
338
Blaze Kansco - GA
- 6 Bye
- 3 Jordan Thompson - VA
339
Logan Morris - VA
- 5 Logan Morris - VA



PL	Name	Wins	Losses
5	Giovanny Adan - AL	1	4
1	Blaze Kansco - GA	5	0
3	Jordan Thompson - VA	3	2
4	Truman Ross - TN	2	3
2	Logan Morris - VA	4	1
6			

Class Novice

Weight 112

Round 4

- 1 Giovanny Adan - AL
437
Logan Morris - VA
- 5 Logan Morris - VA
- 2 Blaze Kansco - GA
438
Blaze Kansco - GA
- 4 Truman Ross - TN
- 3 Jordan Thompson - VA
439
Jordan Thompson - VA
- 6 Bye

Round 5

- 1 Giovanny Adan - AL
517
Giovanny Adan - AL
- 6 Bye
- 2 Blaze Kansco - GA
518
Blaze Kansco - GA
- 3 Jordan Thompson - VA
- 4 Truman Ross - TN
519
Logan Morris - VA
- 5 Logan Morris - VA

Round 1

1 Hank Turner - AL
 _____ 154
 _____ Hank Turner - AL
 2 Seth Cumby - TN

3 Elijah Lawson - TN
 _____ 155
 _____ Elijah Lawson - TN
 4 Bye

Round 2

1 Hank Turner - AL
 _____ 254
 _____ Hank Turner - AL
 3 Elijah Lawson - TN

2 Seth Cumby - TN
 _____ 255
 _____ Seth Cumby - TN
 5 Bye

Round 3

1 Hank Turner - AL
 _____ 340
 _____ Hank Turner - AL
 4 Bye

2 Seth Cumby - TN
 _____ 341
 _____ Seth Cumby - TN
 6 Elijah Lawson - TN

PL	Name	Wins	Losses
1	Hank Turner - AL	3	0
2	Seth Cumby - TN	2	1
3	Elijah Lawson - TN	1	2



- 1 Hank Turner - AL
- 2 Seth Cumby - TN
- 3 Elijah Lawson - TN
- 4 _____

Class

Weight

Class:

Novice

Weight:

130

Round 4

Round 3

Round 2

Round 1

Round 2

Round 4

Hunter Fortner - TN
3rd Place

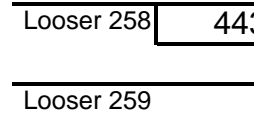
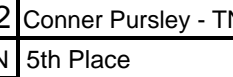
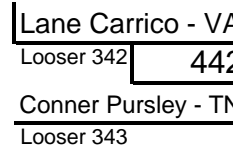
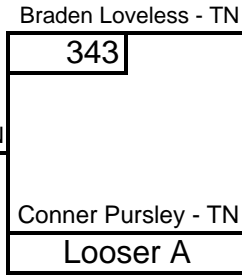
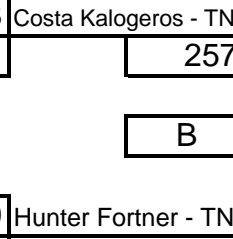
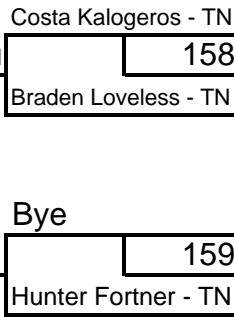
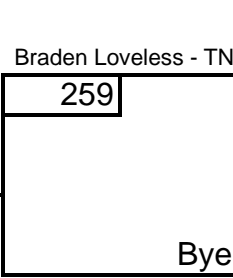
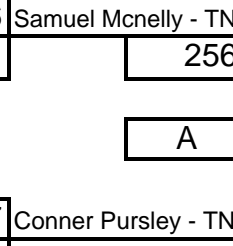
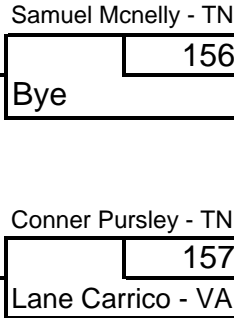
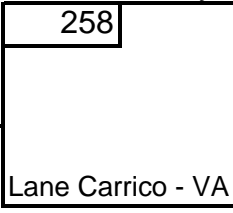
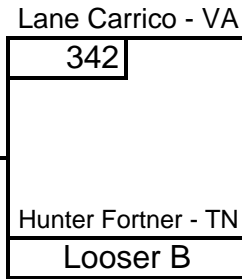
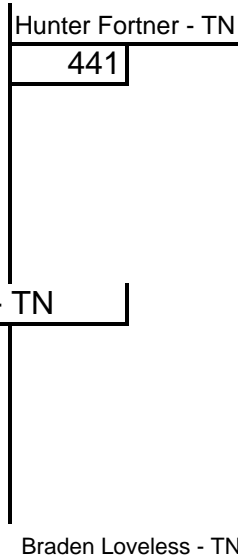

C Samuel Mcnelly
Champion



Round 1

1 Tucker Davis - TN
 _____ 162

 2 Trace Mcnew - TN

 _____ Trace Mcnew - TN

Round 2

1 Tucker Davis - TN
 _____ 262

 3 Trace Mcnew - TN

 _____ Trace Mcnew - TN

**Round 3
If Needed**

1 Tucker Davis - TN
 _____ 346

 4 Trace Mcnew - TN

Best 2 out of 3

PL	Name	Wins	Losses
2	Tucker Davis - TN	0	2
1	Trace Mcnew - TN	2	0

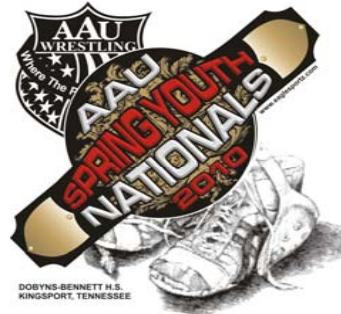

1 Trace Mcnew - TN

 2 Tucker Davis - TN

 3 _____
 4 _____

Class Novice

Weight HWT

Round 1

Round 2

Round 4

Round 6

Weight: **70**

Class: **School Boy**

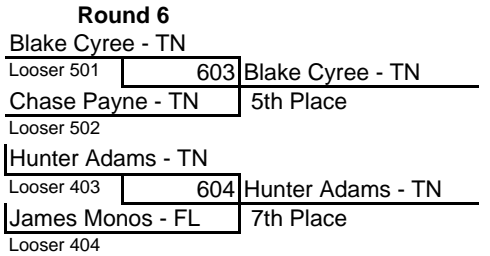
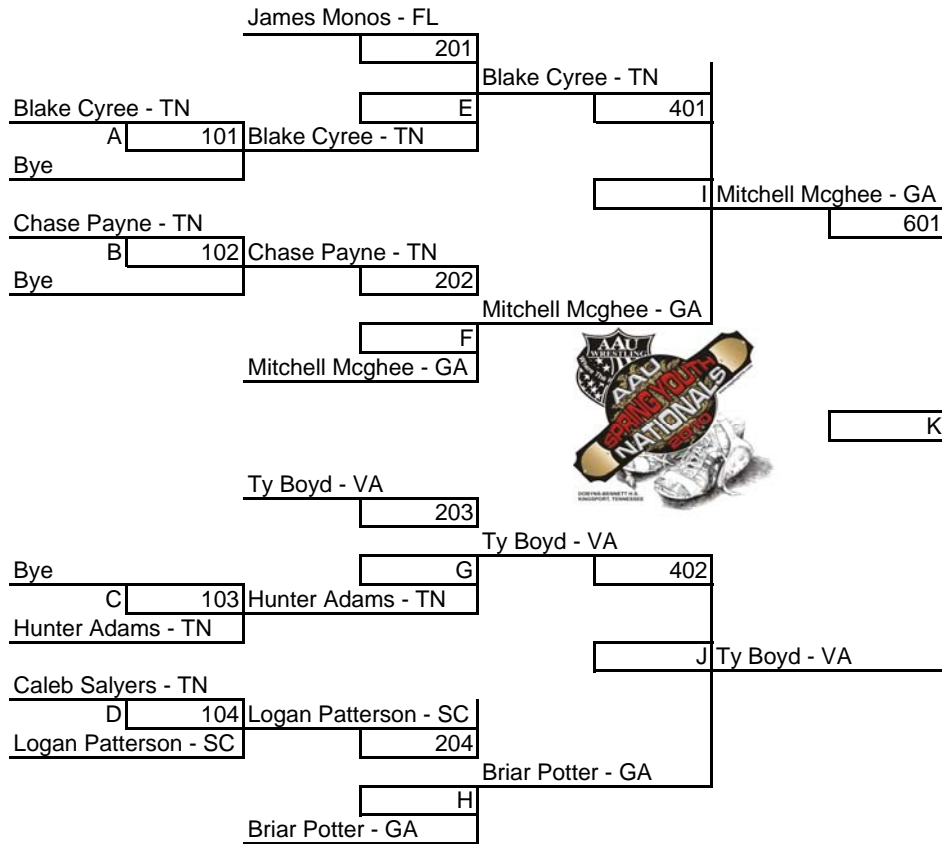

Round 3

Round 4

Round 5

Round 6

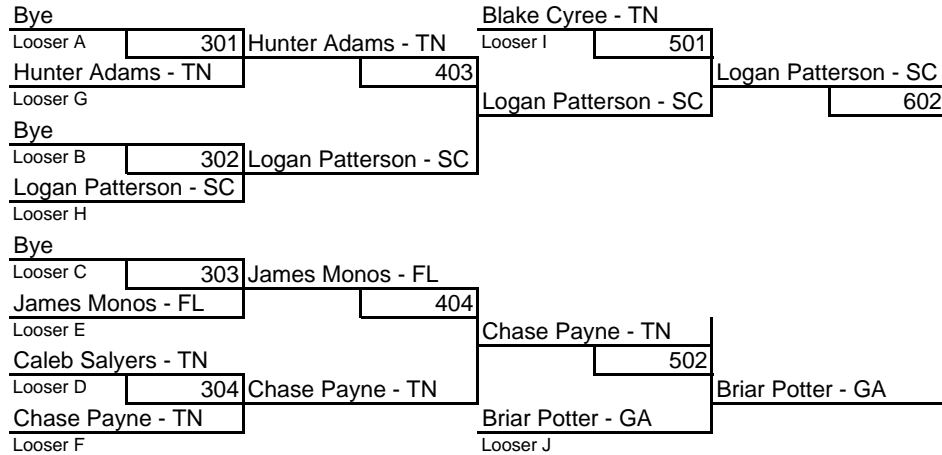

Round 1

Round 2

Round 4

Round 6

Weight: **75**

Class: **School Boy**

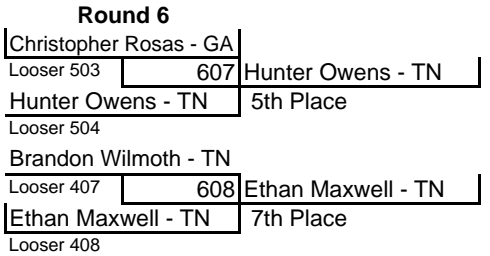
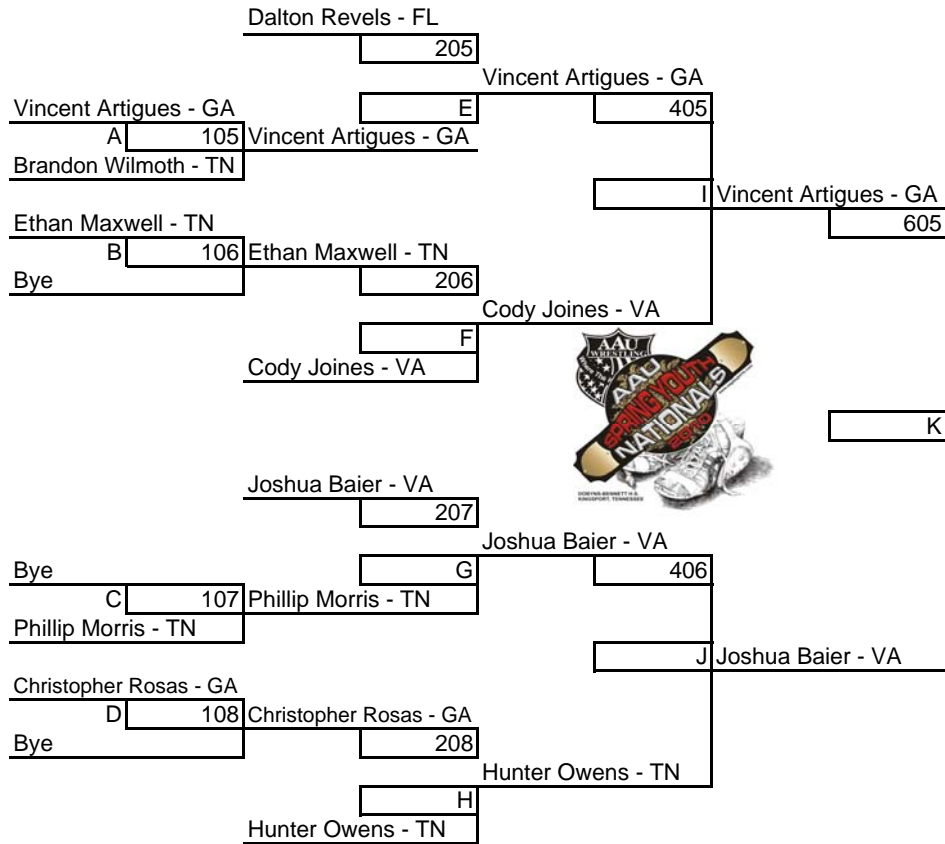

Round 3

Round 4

Round 5

Round 6

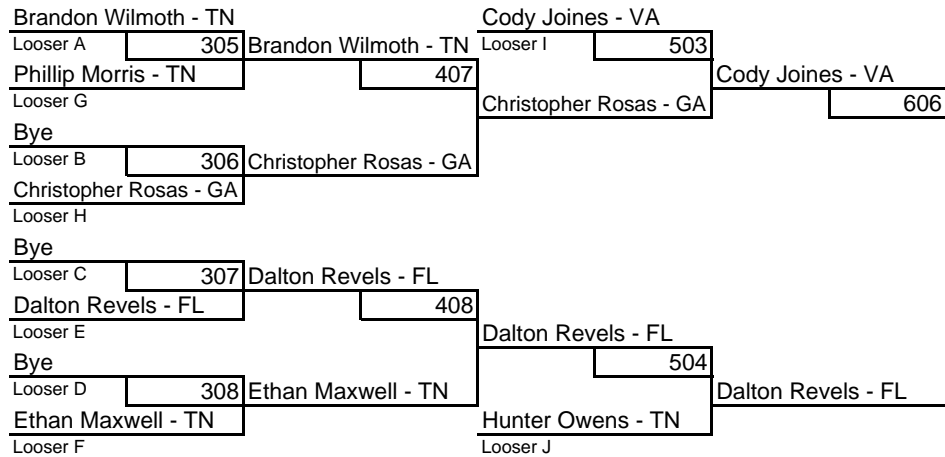

Class:

School Boy

Weight:

80

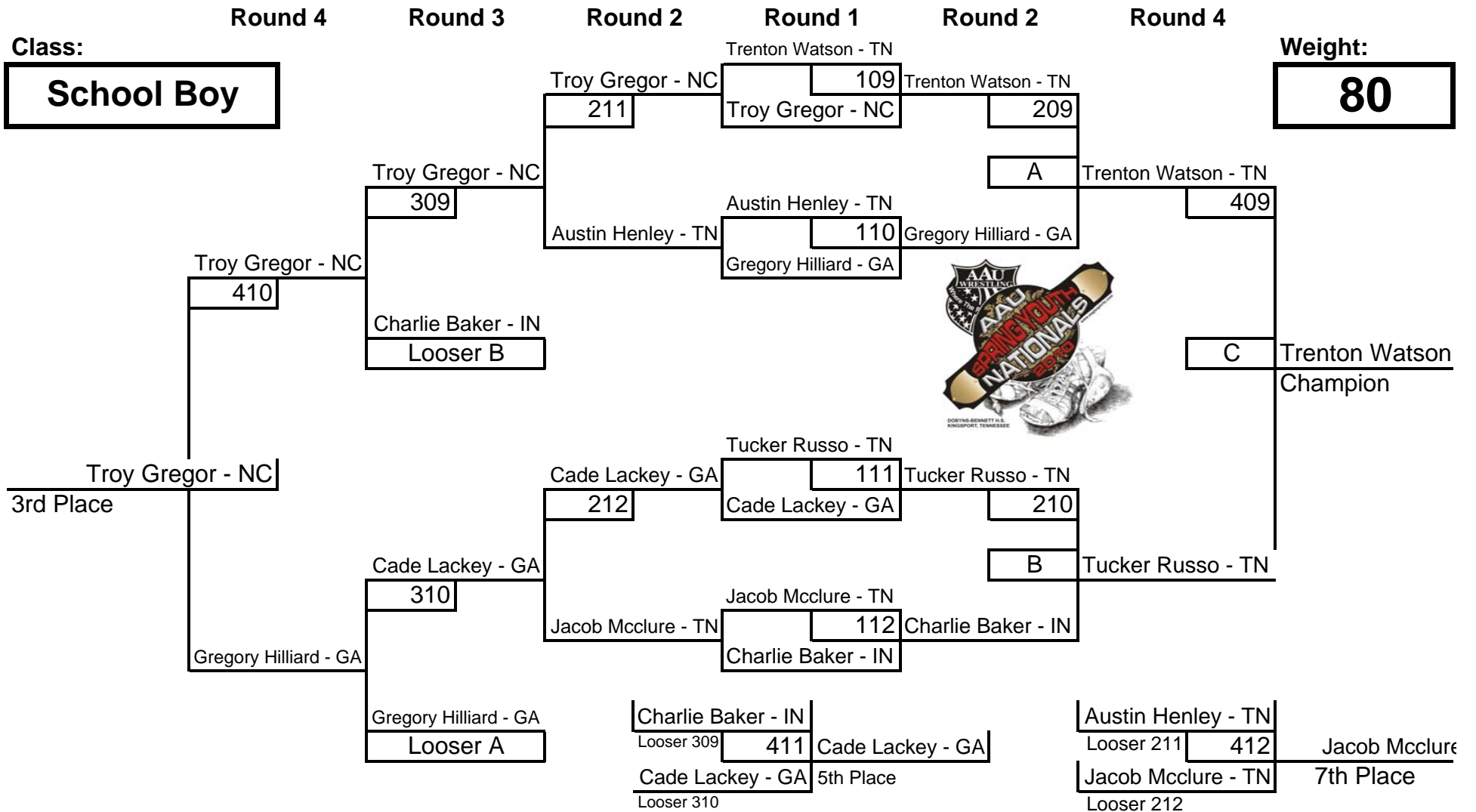

Round 1

Round 2

Round 4

Round 6

Weight: **85**

Class: **School Boy**

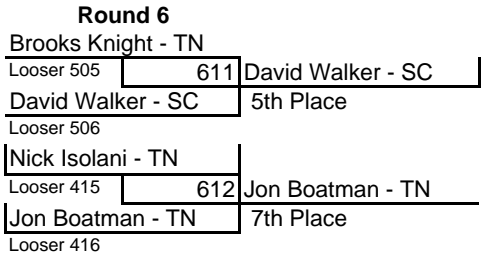
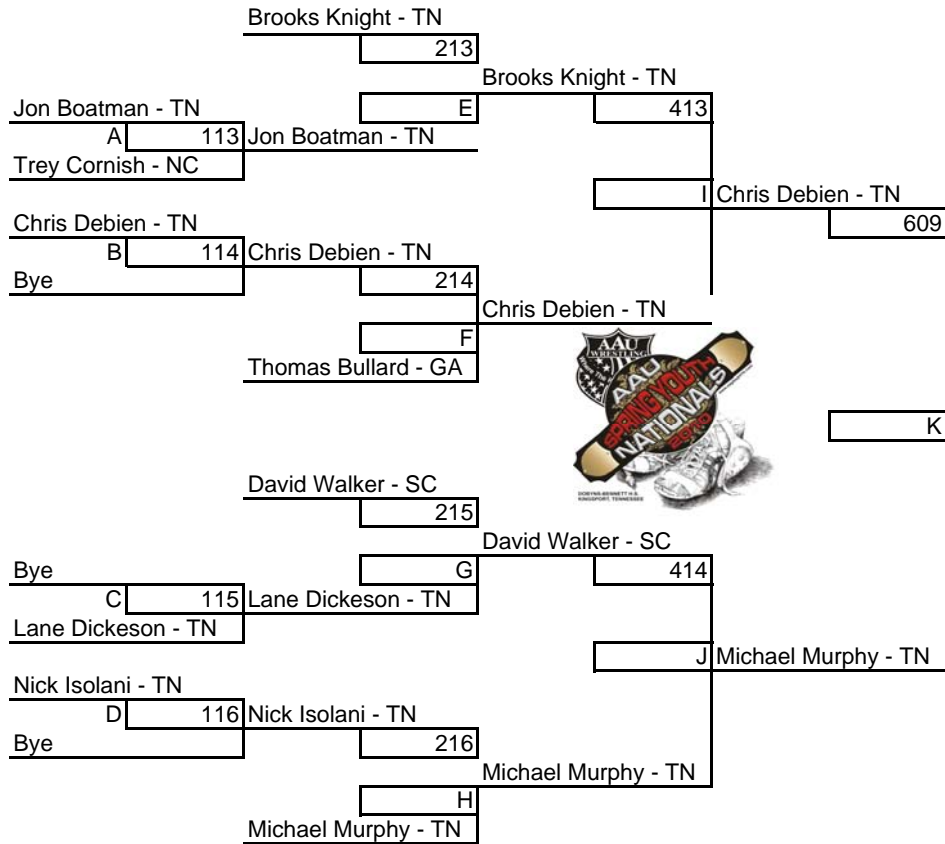

Round 3

Round 4

Round 5

Round 6

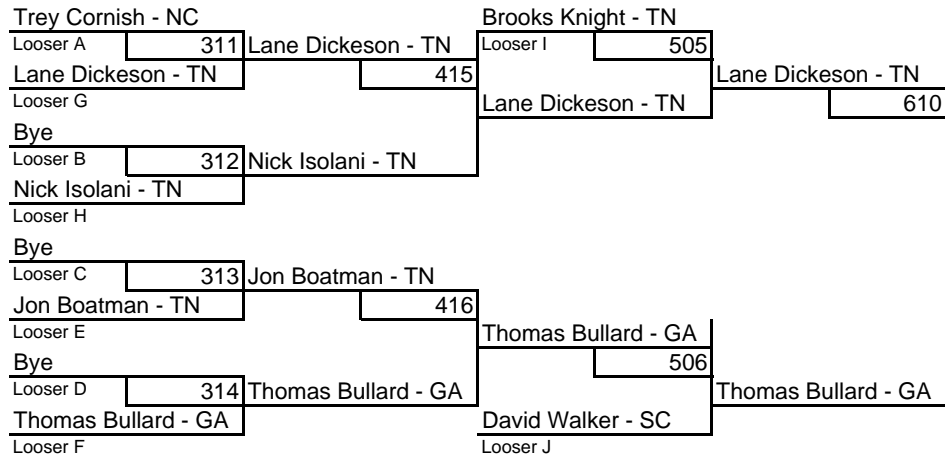

Thomas Bullard - GA
3rd Place

Round 1

Round 2

Round 4

Round 6

Weight: **90**

Class: **School Boy**

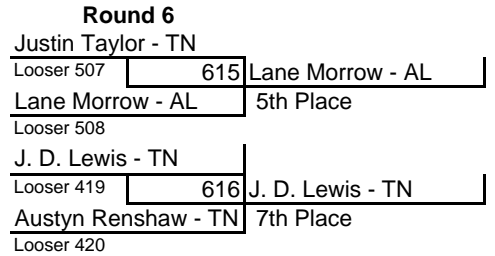
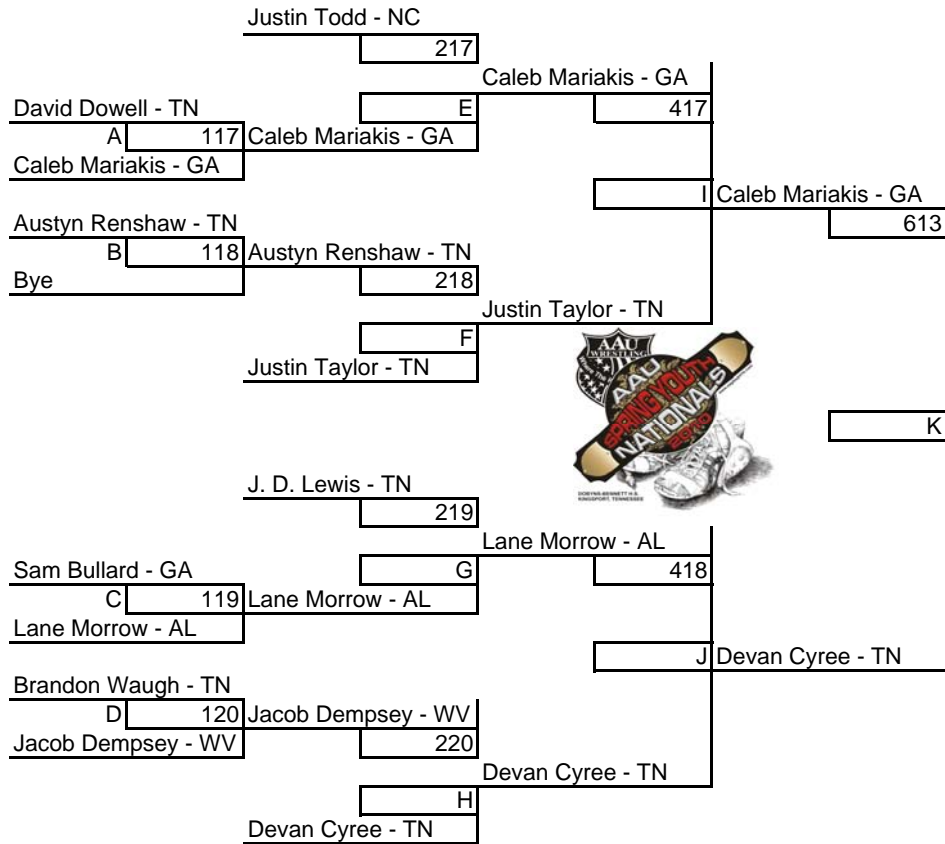

Round 3

Round 4

Round 5

Round 6

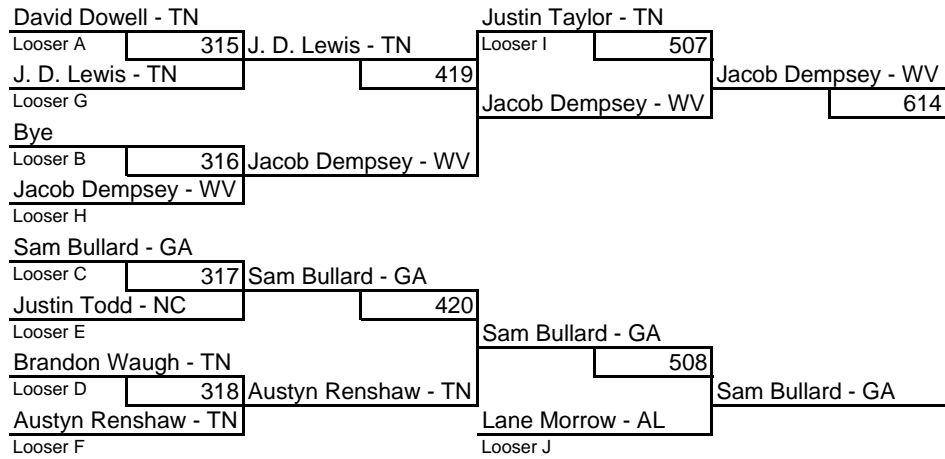

Sam Bullard - GA
3rd Place



Weight: **95**
 Class: **School Boy**

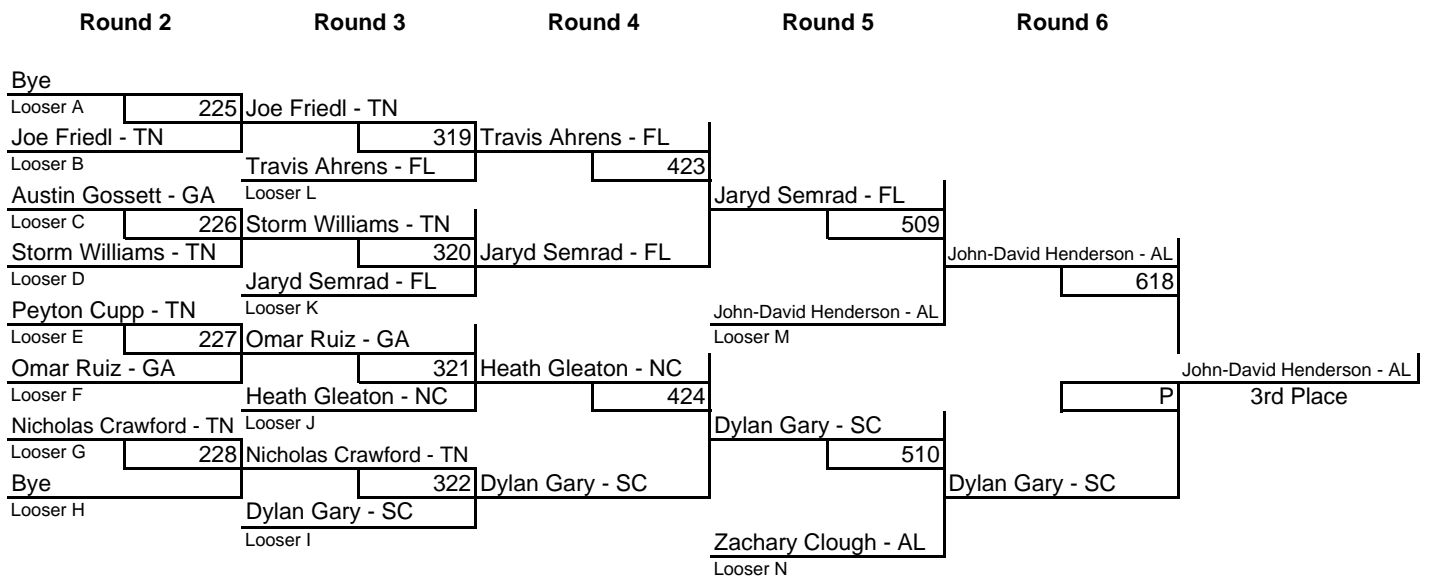
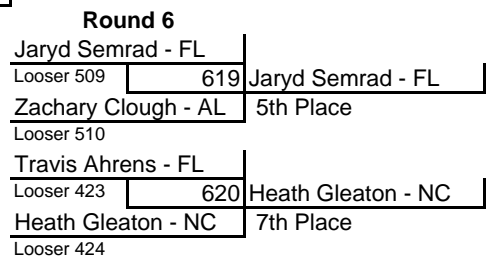

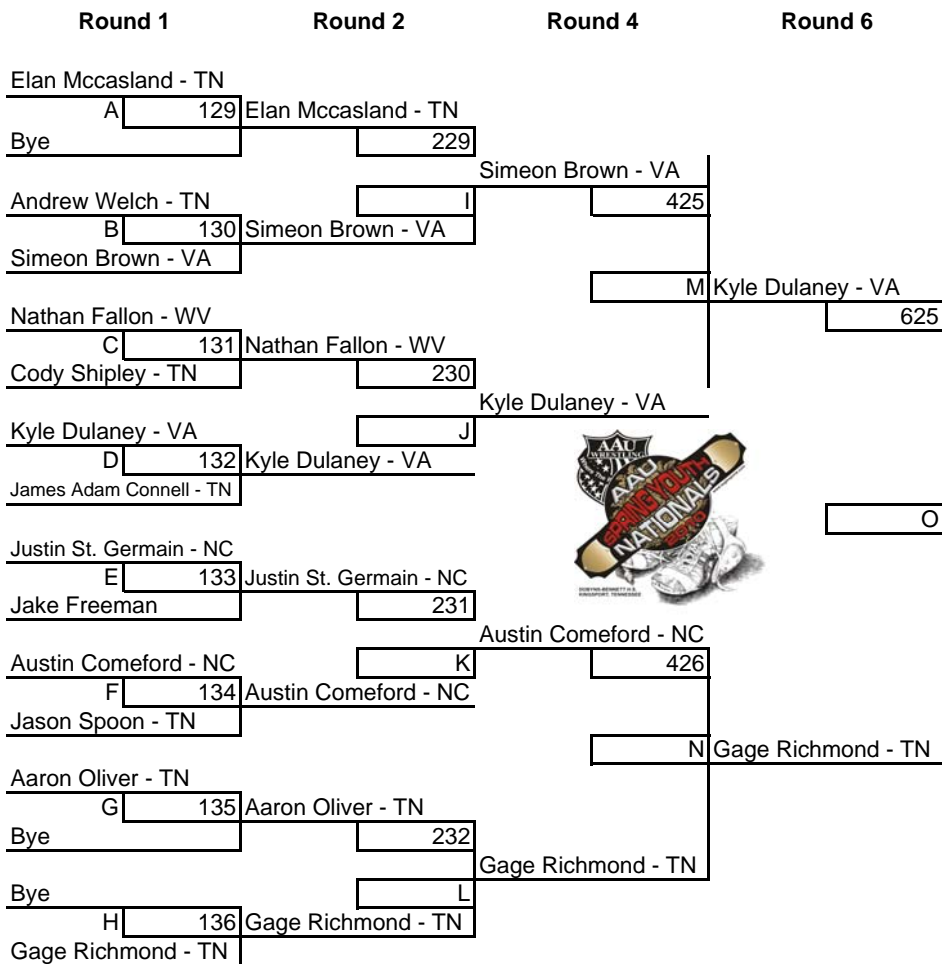

Weight: **100**

Class: **School Boy**

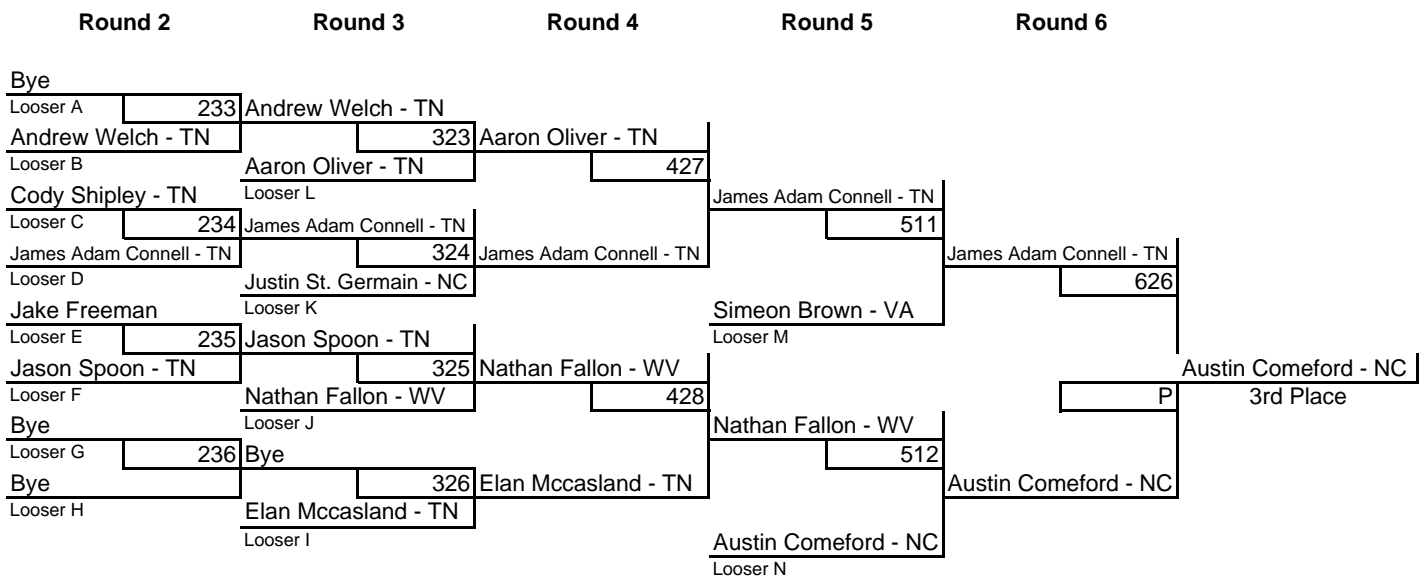
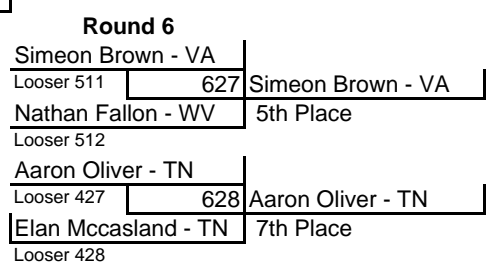

Round 1

Round 2

Round 4

Round 6

Weight: **105**

Class: **School Boy**

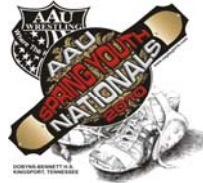
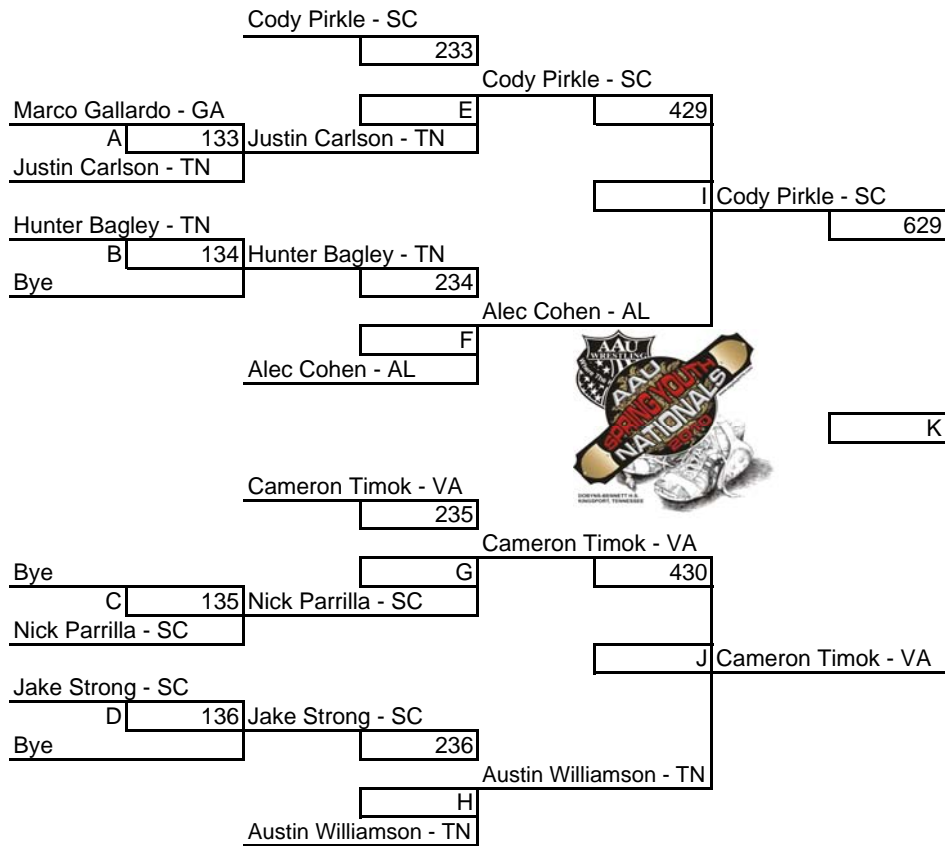

Cameron Timok - VA
Champion

Round 6



Round 3

Round 4

Round 5

Round 6

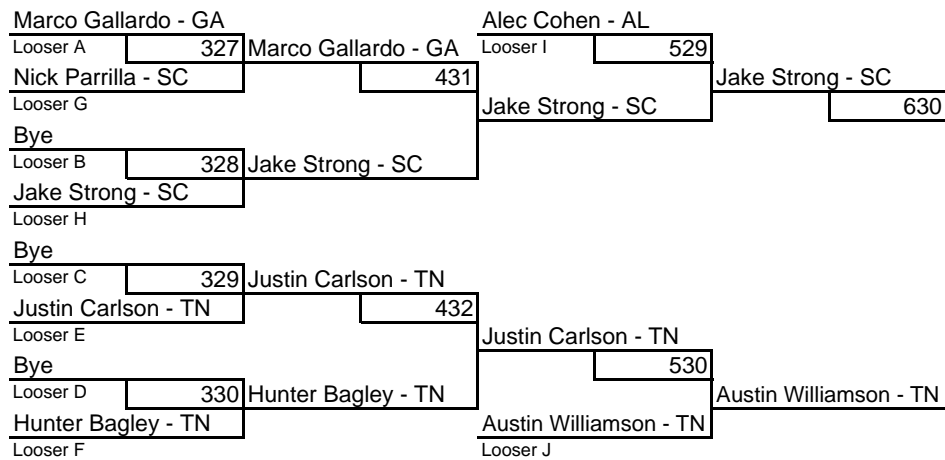

Class:

School Boy

Weight:

110

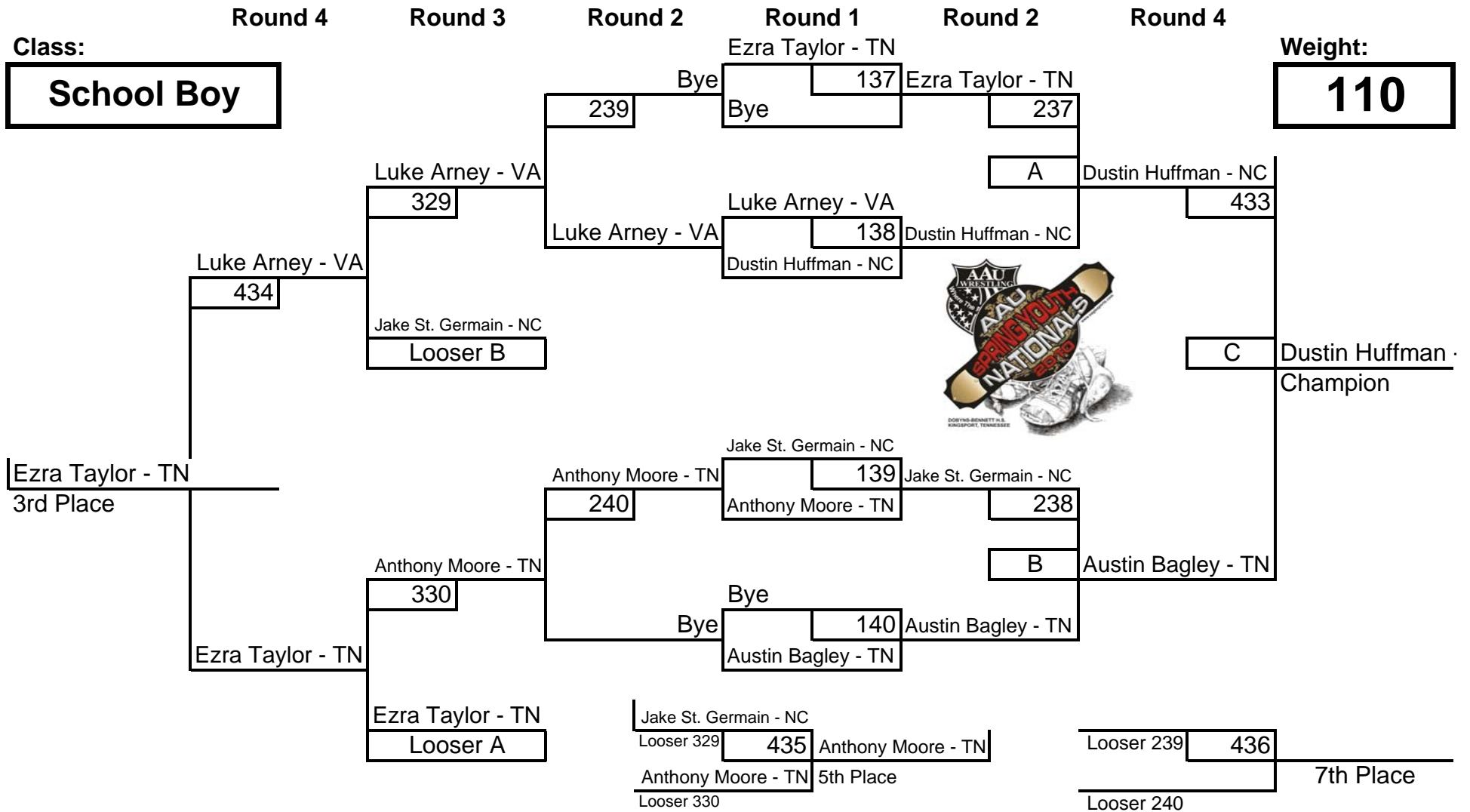

Round 1

Round 2

Round 4

Round 6

Weight: **115**

Class: **School Boy**

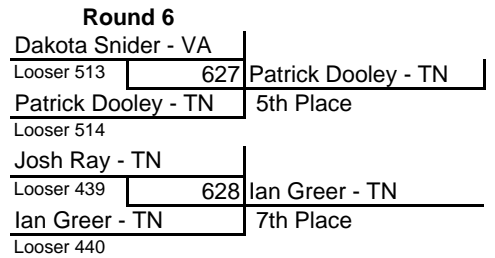
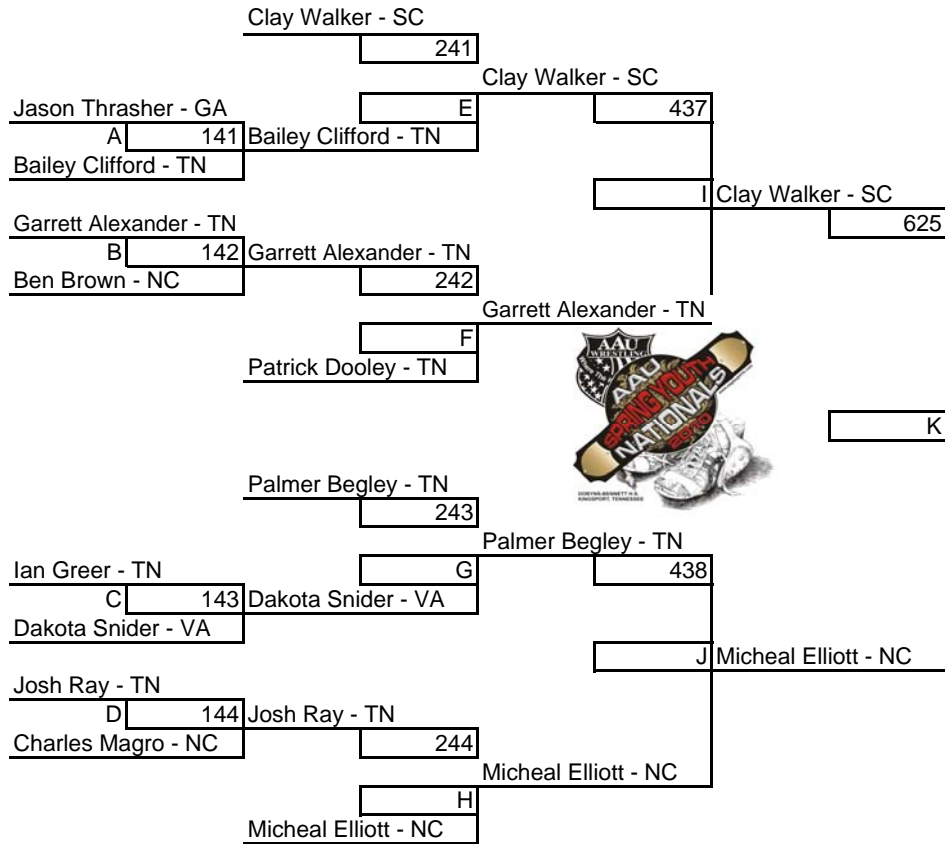

Round 3

Round 4

Round 5

Round 6

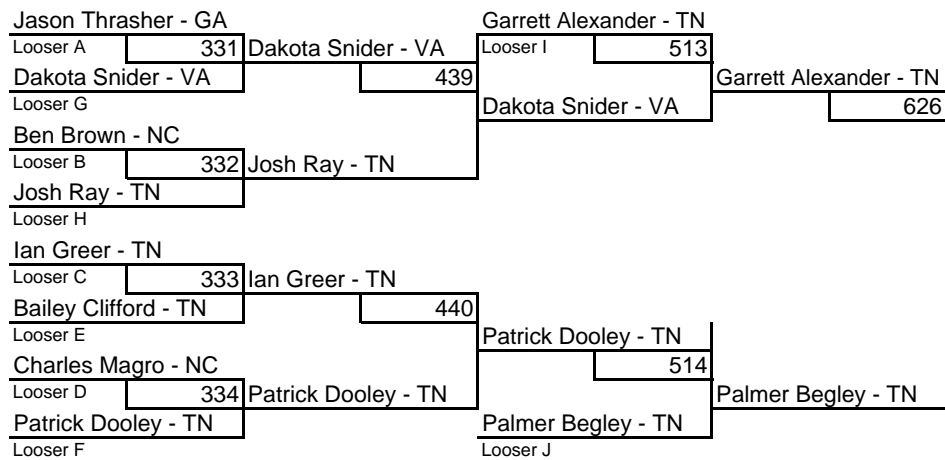

Class:

School Boy

Weight:

120

Round 4

Round 3

Round 2

Round 1

Round 2

Round 4

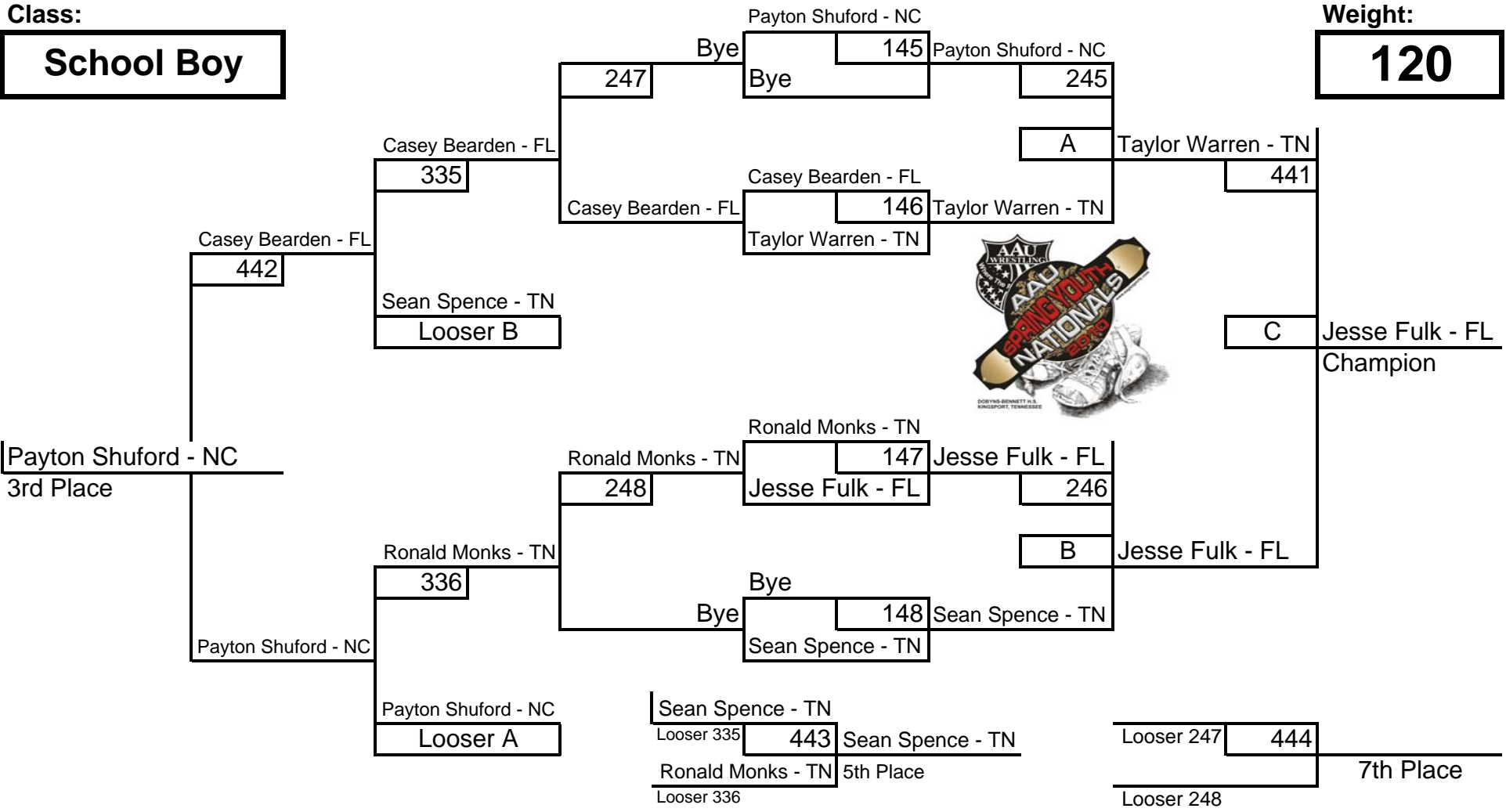

Round 1

Round 2

Round 4

Round 6

Weight: **125**

Class: **School Boy**

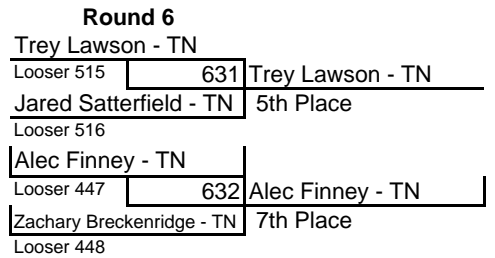
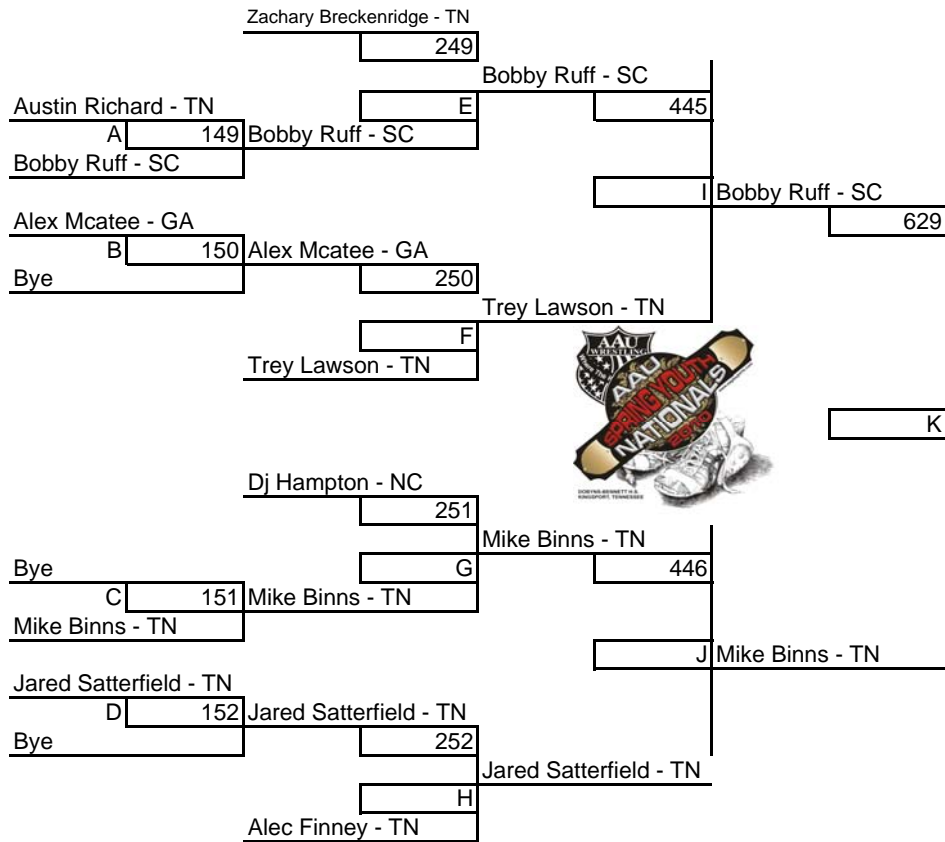

Round 3

Round 4

Round 5

Round 6

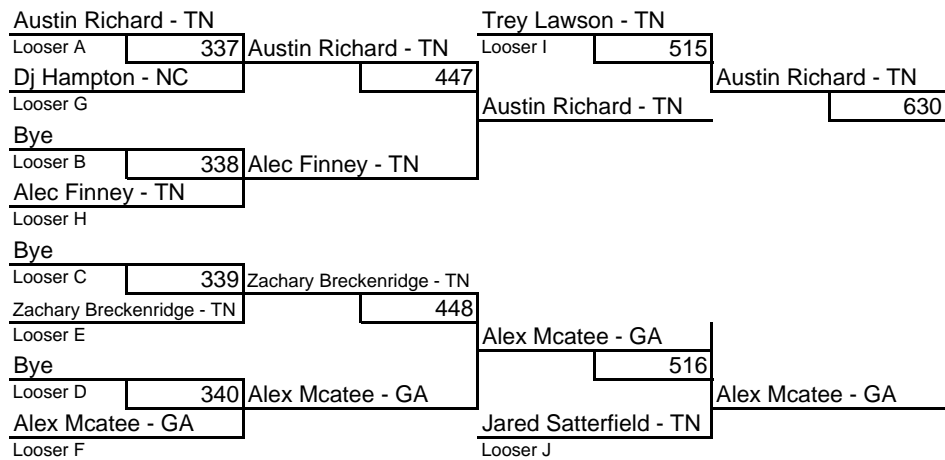

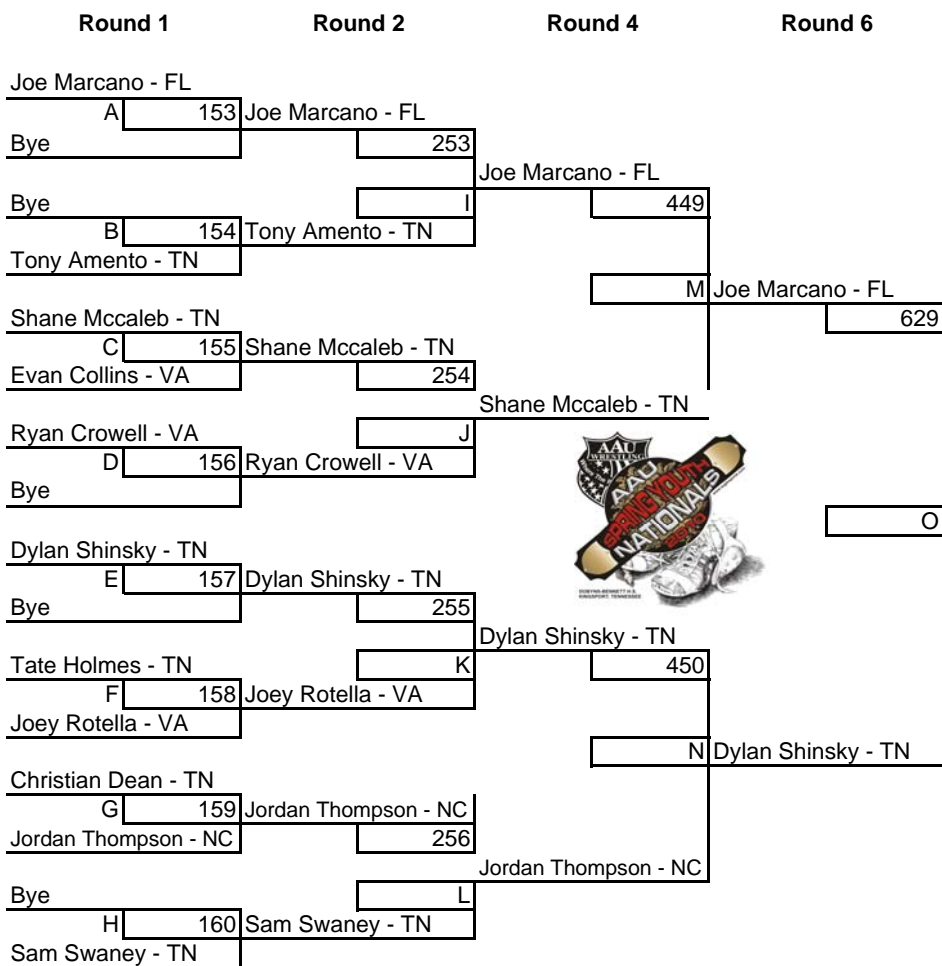

Weight: **130**

Class: **School Boy**



Round 6
 Shane Mccaleb - TN
 Looser 515 631 Shane Mccaleb - TN
 Jordan Thompson - NC 5th Place
 Looser 516
 Sam Swaney - TN
 Looser 451 632 Christian Dean - TN
 Christian Dean - TN 7th Place
 Looser 452

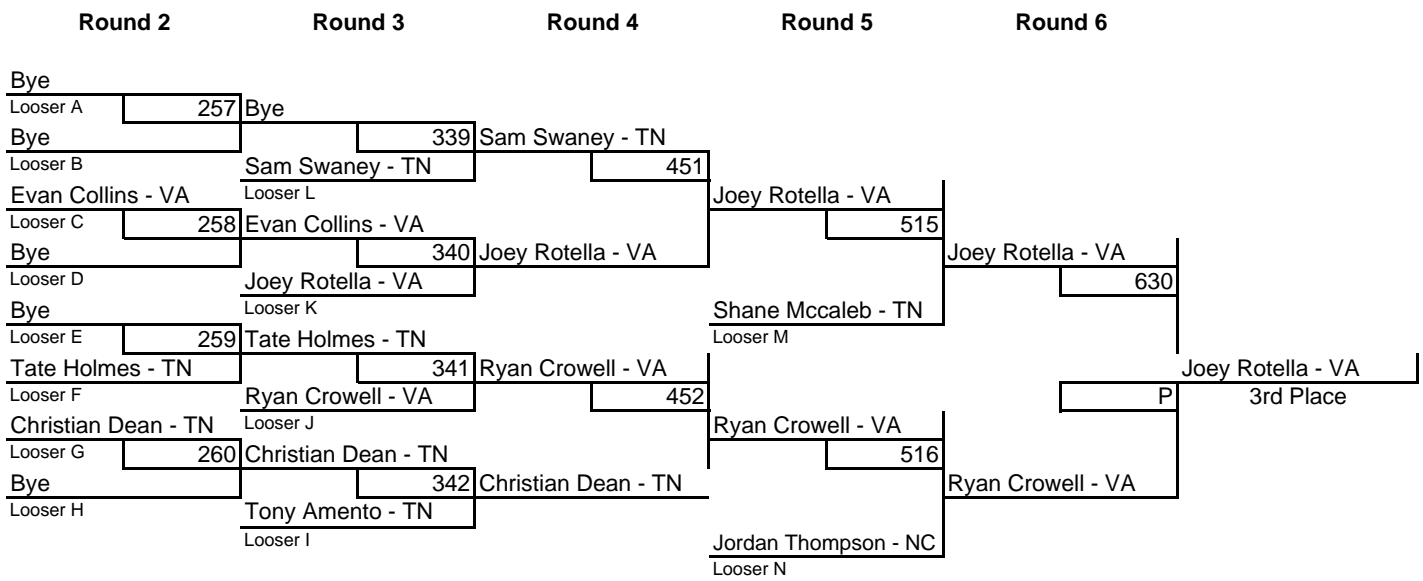

Round 6
 Joey Rotella - VA
 Looser 515 631 Joey Rotella - VA
 Ryan Crowell - VA 3rd Place
 Looser 516
 Christian Dean - TN
 Looser 452

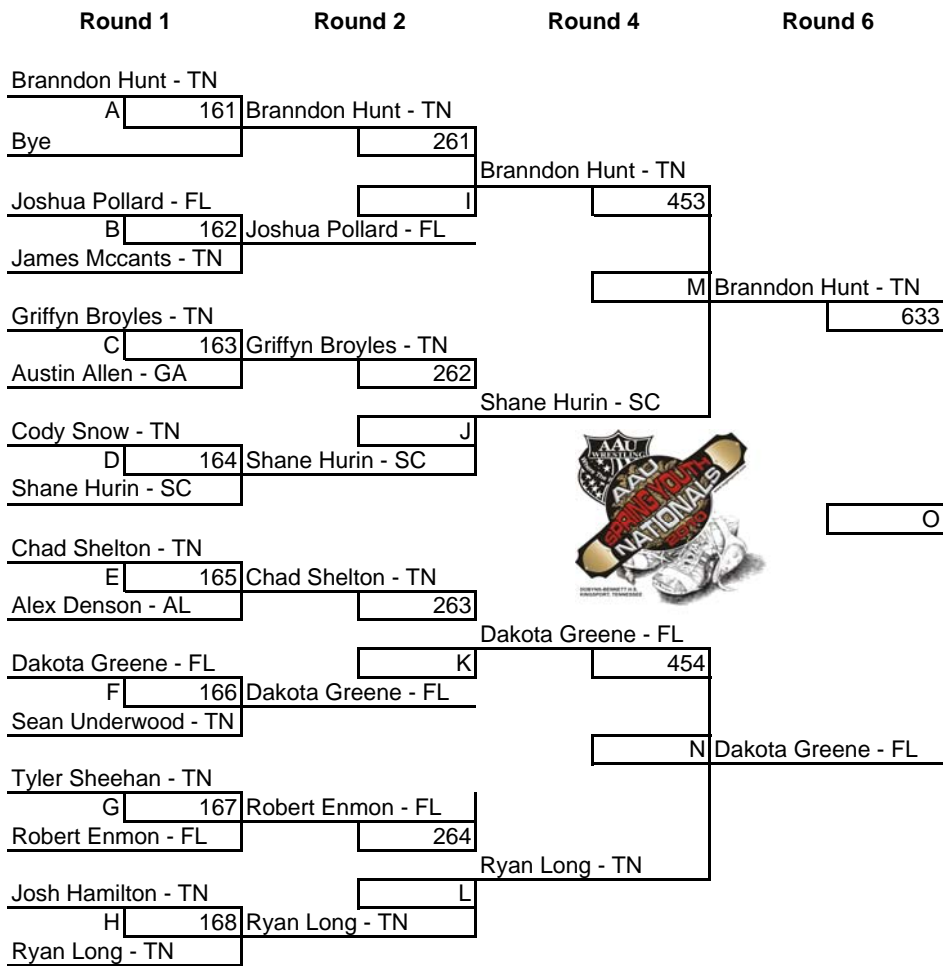

Weight: **140**
Class: **School Boy**



Brandon Hunt - TN
O
Champion

Round 6
Chad Shelton - TN
Looser 517 635 Chad Shelton - TN
Alex Denson - AL 5th Place
Looser 518
Robert Enmon - FL
Looser 455 636 Joshua Pollard - FL
Joshua Pollard - FL 7th Place
Looser 456

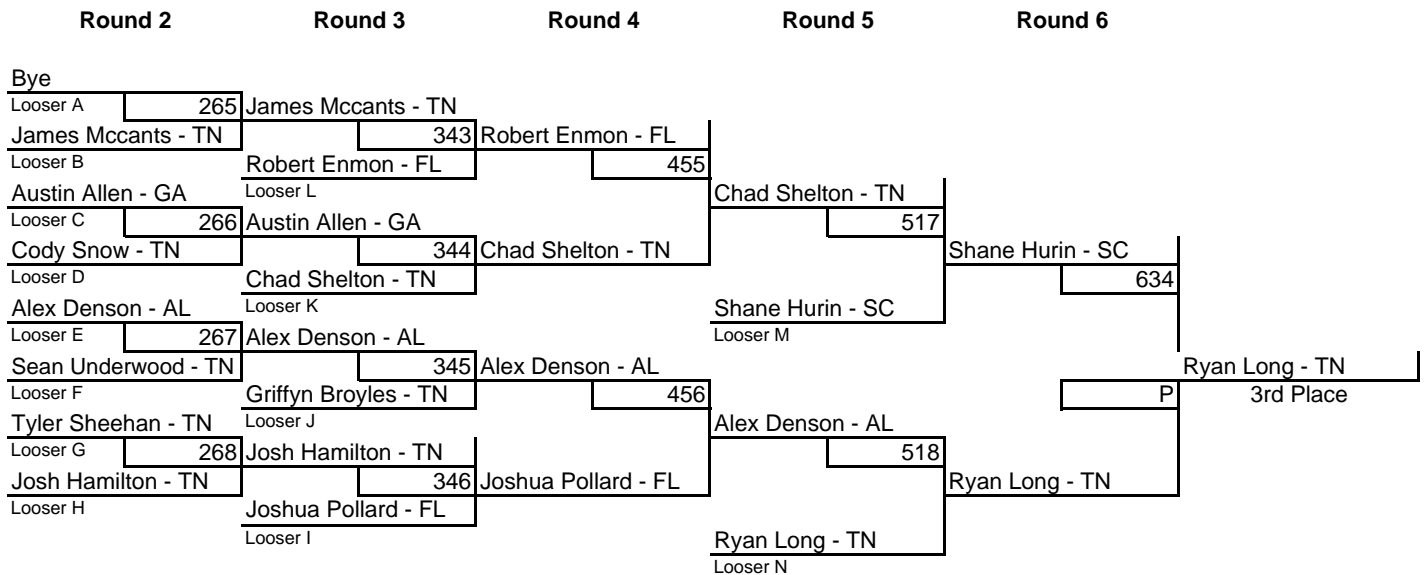

Class:

School Boy

Weight:

150

Round 4

Round 3

Round 2

Round 1

Round 2

Round 4

Xavier Satterfield - TN

Xavier Satterfield - TN

271

169

Logan Dean - VA

269

Xavier Satterfield - TN

347

Bye

Bye

170

Schuyler Larue - TN

A

Logan Dean - VA

457

Xavier Satterfield - TN

458

T.J. Watson - TN

Looser B

T.J. Watson - TN

Skyler Lambert - SC

272

171

T.J. Watson - TN

270

Joseph Taylor - TN

348

Joseph Taylor - TN

Joseph Taylor - TN

172

Eddie Mcgrail - NC

B

Eddie Mcgrail - NC

Schuyler Larue - TN

Schuyler Larue - TN

Looser A

T.J. Watson - TN

Looser 347

459

Joseph Taylor - TN

Joseph Taylor - TN

Looser 348

5th Place

Looser 271

460

Skyler Lambert -

Skyler Lambert - SC

Looser 272

7th Place

Schuyler Larue - TN

3rd Place

C

Logan Dean - VA

Champion



Class:

School Boy

Weight:

160

Round 4

Round 3

Round 2

Round 1

Round 2

Round 4

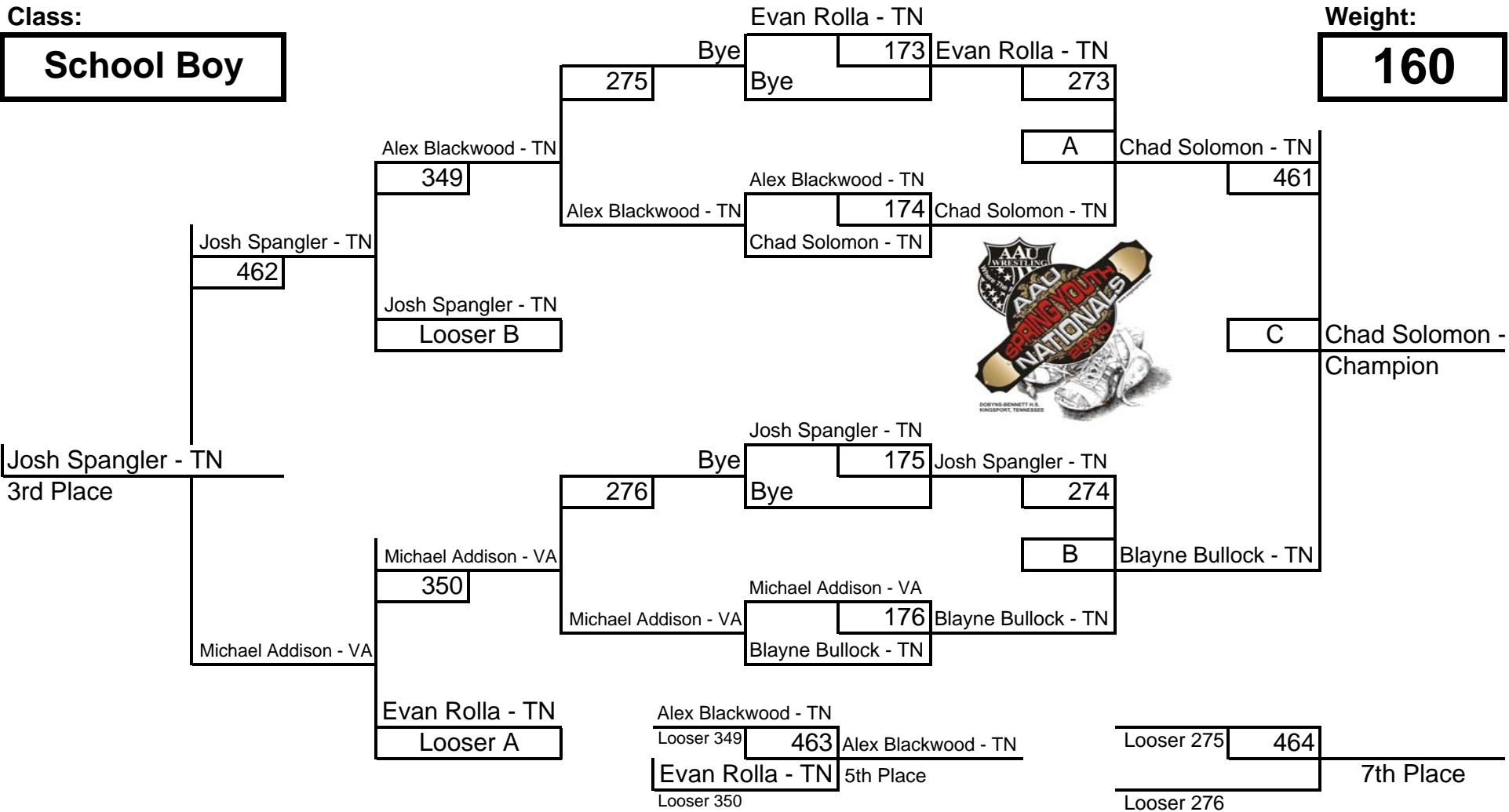

Round 1

Round 2

Round 4

Round 6

Weight: **180**

Class: **School Boy**

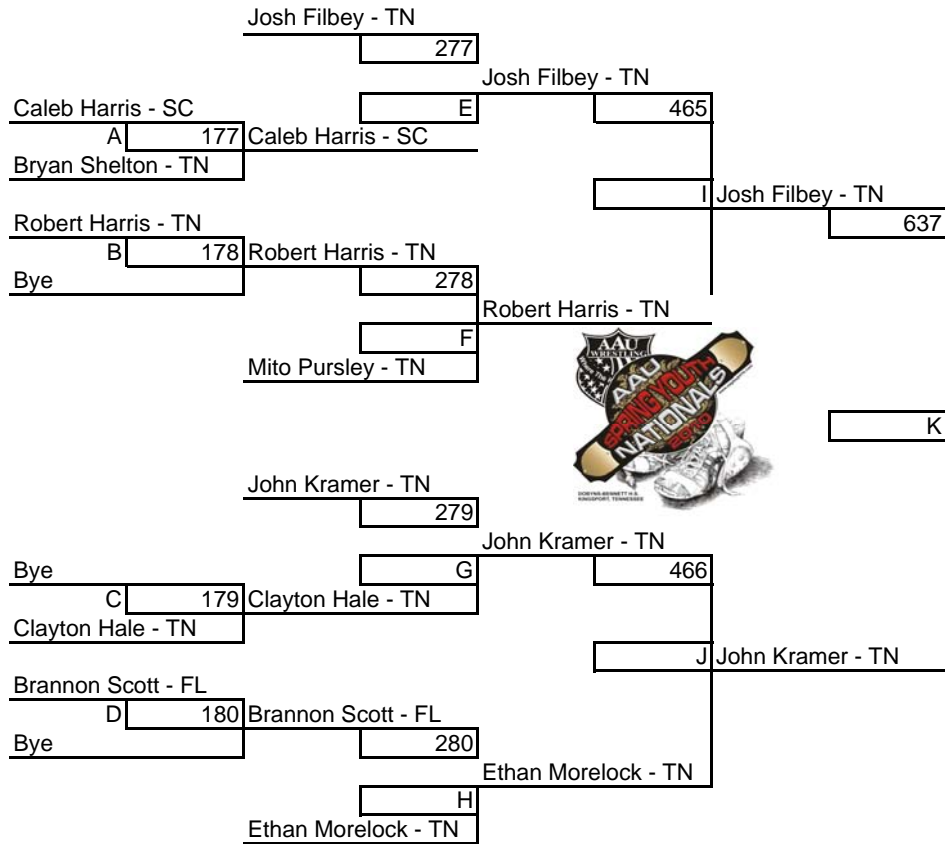

Josh Filbey - TN
Champion

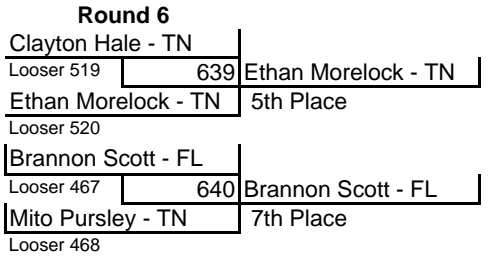

Round 3

Round 4

Round 5

Round 6

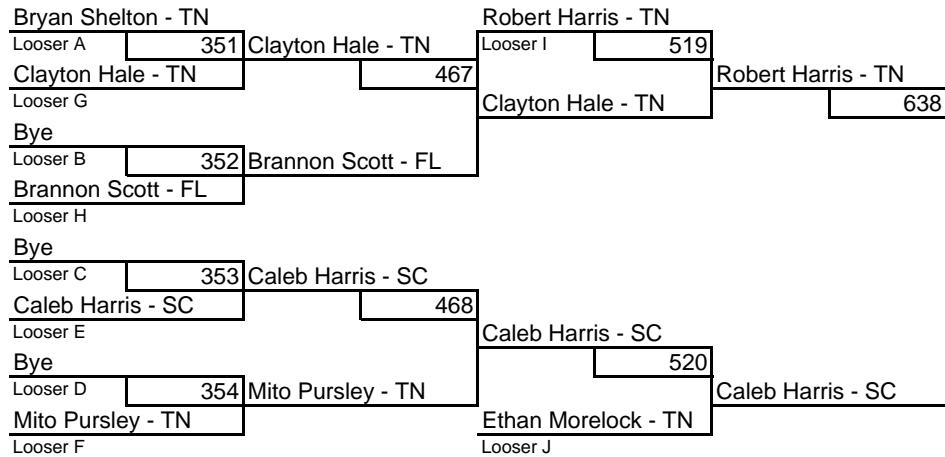

Caleb Harris - SC
3rd Place

Round 1

- 1 Zachary Hodge - TN
181
Zachary Hodge - TN
- 2 Hunter Addison - VA
- 3 Slade Lambert - SC
182
Deme Kalogeros - TN
- 4 Deme Kalogeros - TN
- 5 Justin Davenport - GA
183
Justin Davenport - GA
- 6 Bye

Round 2

- 1 Zachary Hodge - TN
281
Zachary Hodge - TN
- 3 Slade Lambert - SC
- 2 Hunter Addison - VA
282
Justin Davenport - GA
- 5 Justin Davenport - GA
- 4 Deme Kalogeros - TN
283
Deme Kalogeros - TN
- 6 Bye

Round 3

- 1 Zachary Hodge - TN
355
Zachary Hodge - TN
- 4 Deme Kalogeros - TN
- 2 Hunter Addison - VA
356
Hunter Addison - VA
- 6 Bye
- 3 Slade Lambert - SC
357
Justin Davenport - GA
- 5 Justin Davenport - GA



PL	Name	Wins	Losses
1	Zachary Hodge - TN	5	0
3	Hunter Addison - VA	3	2
5	Slade Lambert - SC	1	4
4	Deme Kalogeros - TN	2	3
2	Justin Davenport - GA	4	1

Class School Boy

Weight HWT

Round 4

- 1 Zachary Hodge - TN
469
Zachary Hodge - TN
- 5 Justin Davenport - GA
- 2 Hunter Addison - VA
470
Hunter Addison - VA
- 4 Deme Kalogeros - TN
- 3 Slade Lambert - SC
471
Slade Lambert - SC
- 6 Bye

Round 5

- 1 Zachary Hodge - TN
521
Zachary Hodge - TN
- 6 Bye
- 2 Hunter Addison - VA
522
Hunter Addison - VA
- 3 Slade Lambert - SC
- 4 Deme Kalogeros - TN
523
Justin Davenport - GA
- 5 Justin Davenport - GA

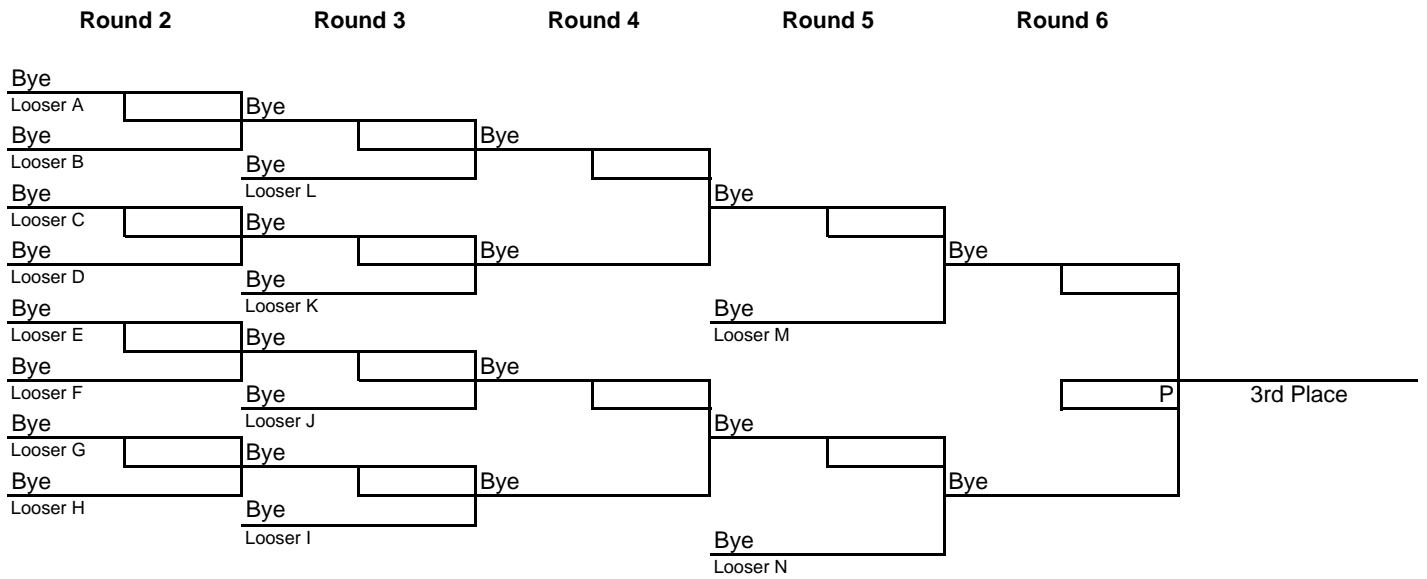
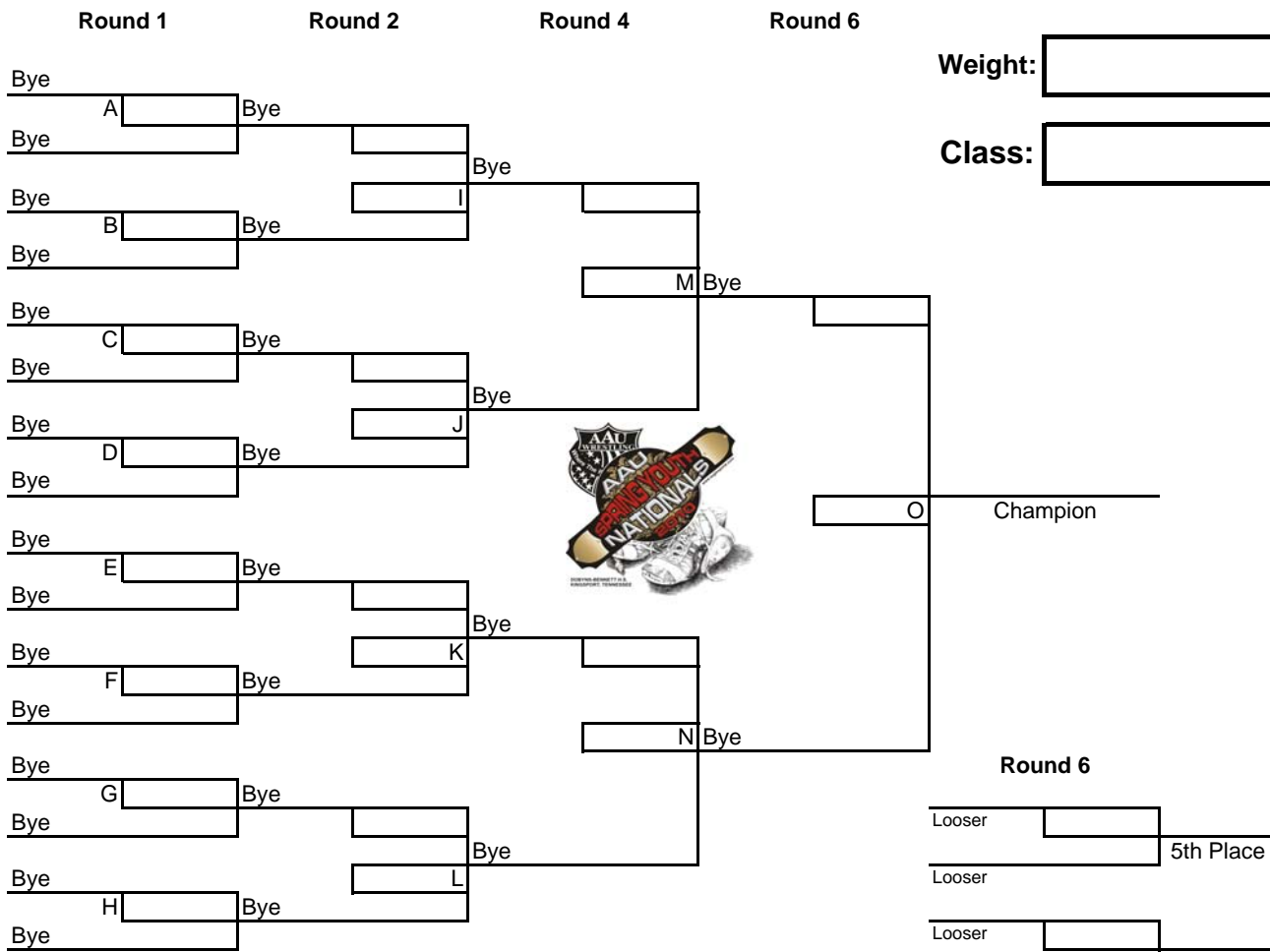

Round 1

Round 2

Round 4

Round 6

Weight:

Class:

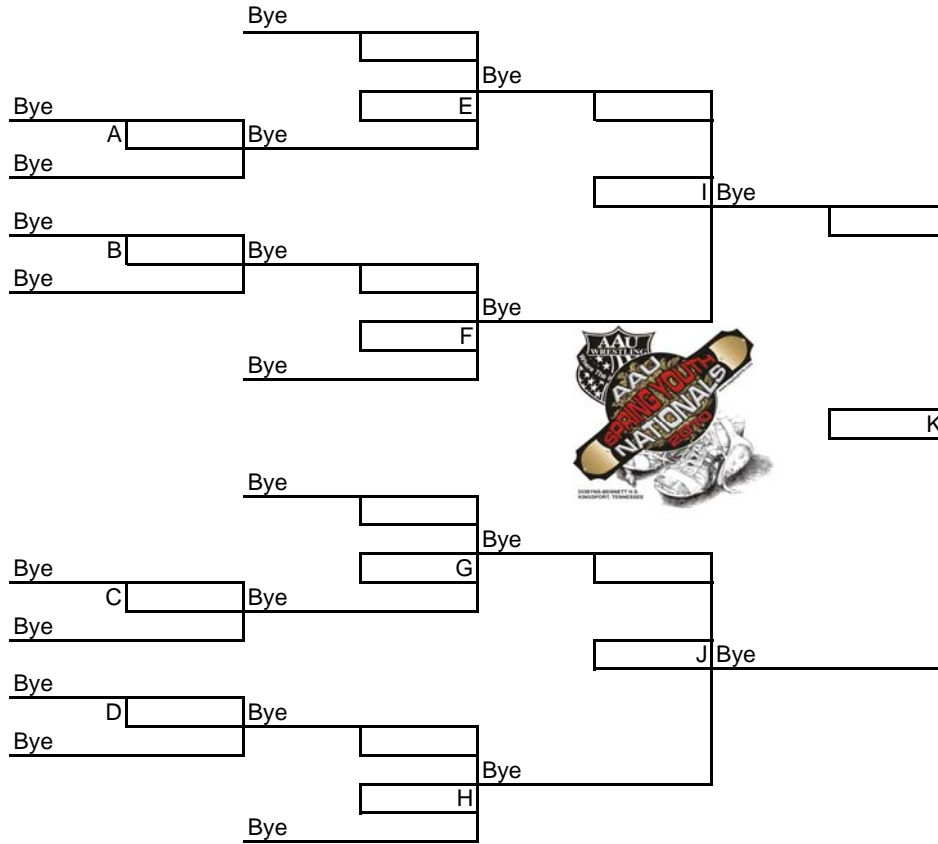

Round 6

Looser 5th Place

Looser

Looser 7th Place

Looser

Round 3

Round 4

Round 5

Round 6

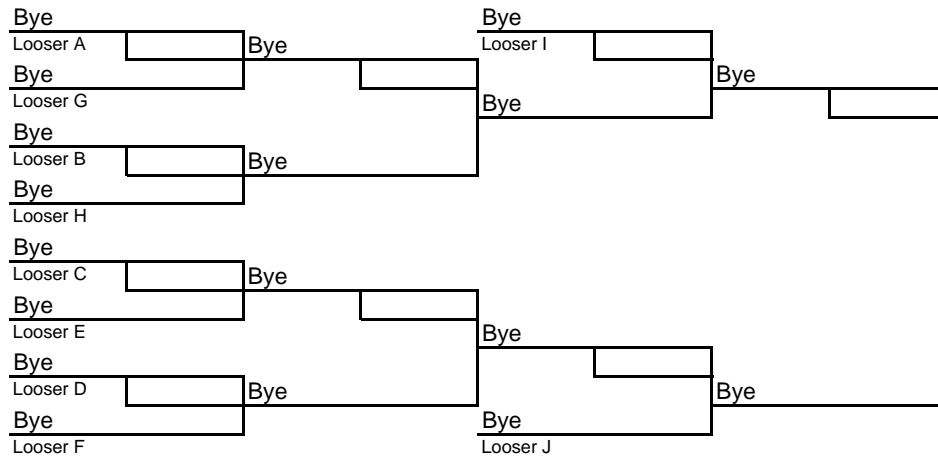

3rd Place

Class:

Weight:

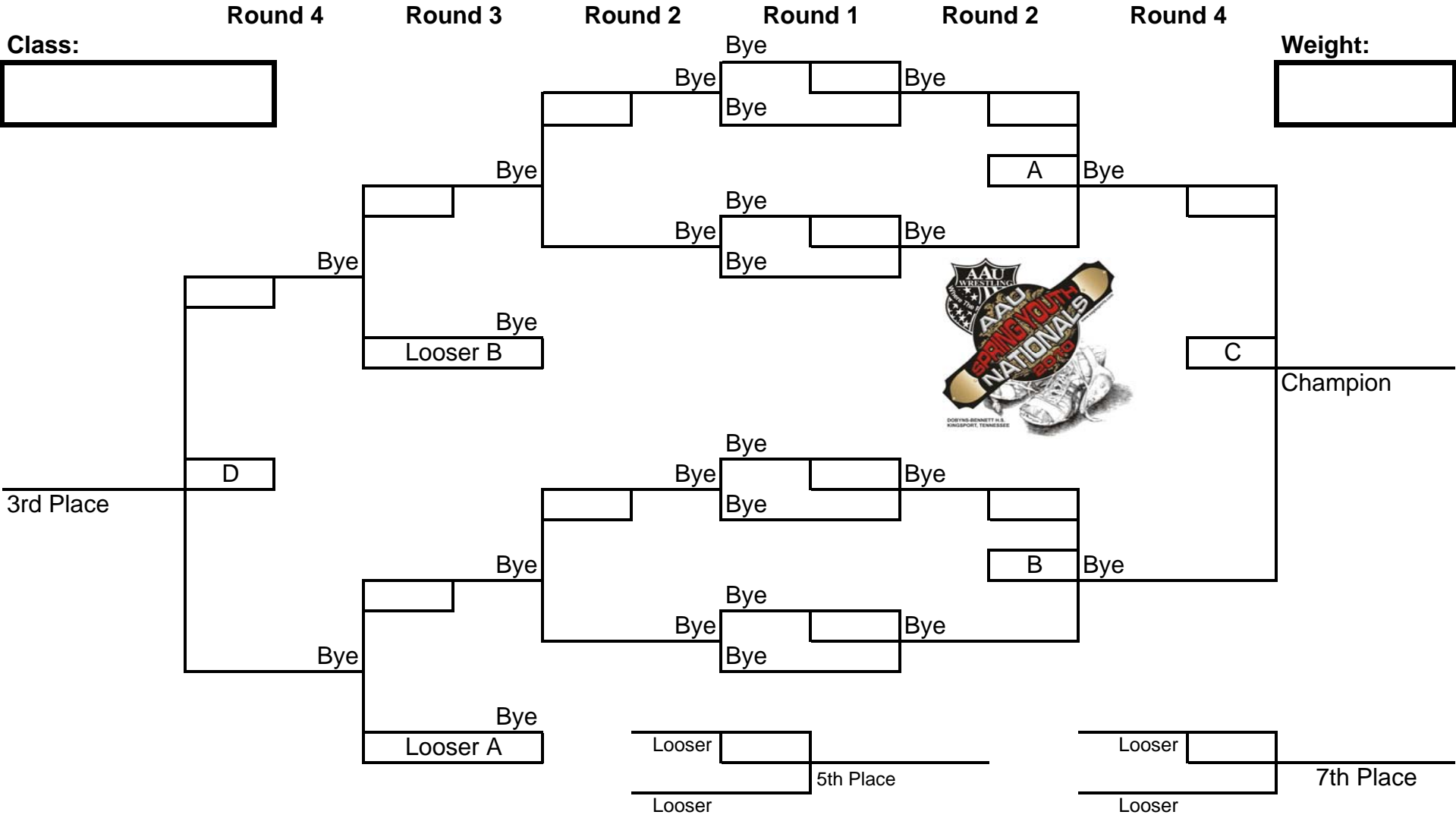

Round 1

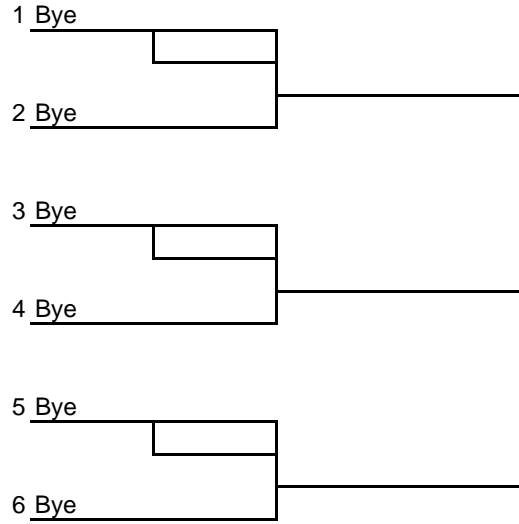

Round 2

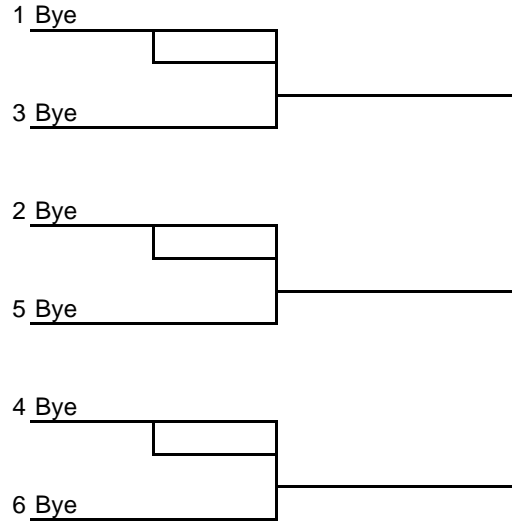

Round 3

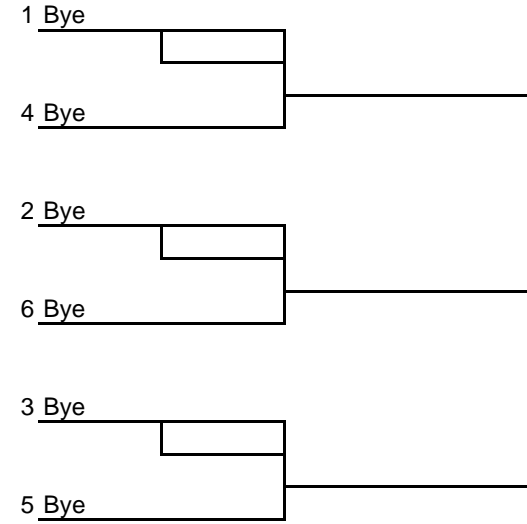

Round 4

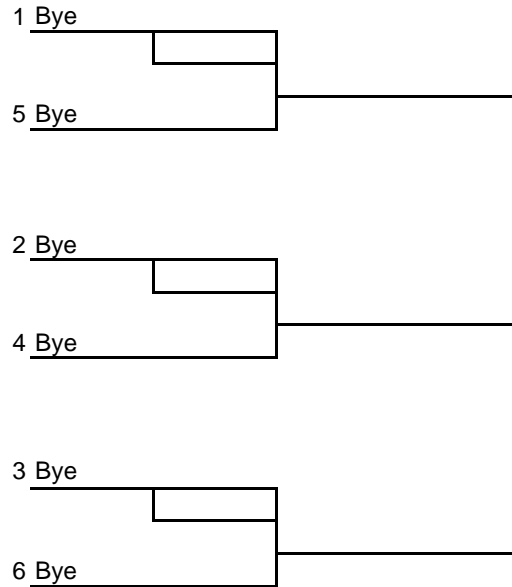

Round 5

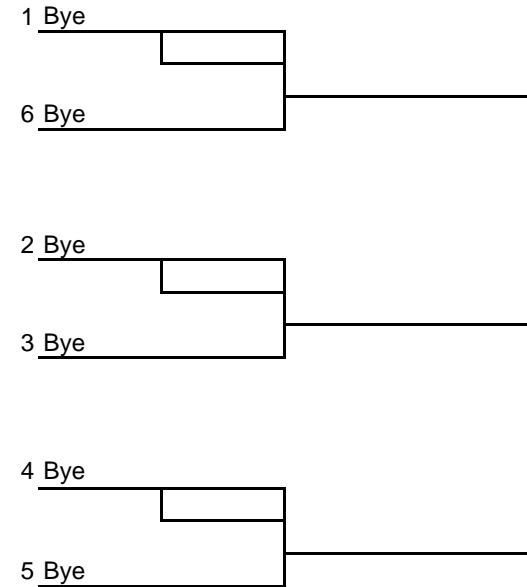

	Name	Wins	Losses
1			
2			
3			
4			
5			
6			

Class

Weight

Round 1

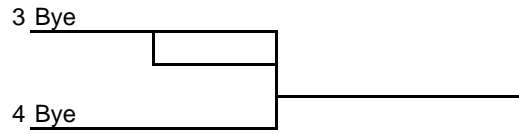
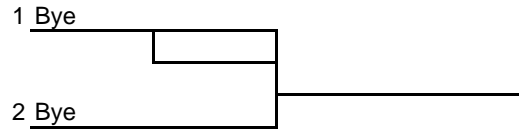

Round 2

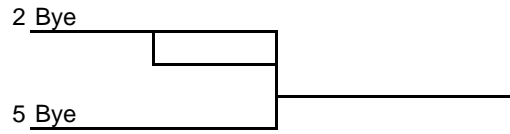
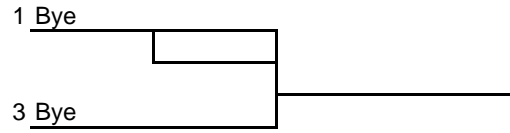

Round 3

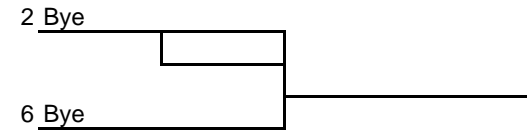
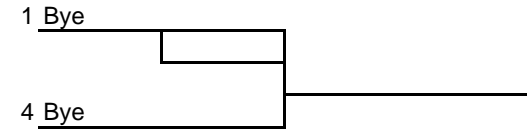

	Name	Wins	Losses
1			
2			
3			
4			



- 1 _____
- 2 _____
- 3 _____
- 4 _____

Class

Weight